

# HP 5361B

## Pulse/CW Microwave Counter

*(Also applies to the HP 5361A 20 GHz Pulse/CW Microwave Counter)*

SERIAL NUMBER PREFIX: 3023

This manual applies to instruments with serial numbers prefixed 3023, unless accompanied by a Manual Change Sheet indicating otherwise.

For additional information about serial numbers, refer to INSTRUMENTS COVERED BY THIS MANUAL in "HOW TO USE THIS MANUAL GUIDE" following the Table of Contents.

© Copyright HEWLETT-PACKARD COMPANY 1990, 1993  
5301 Stevens Creek Boulevard • Santa Clara, California 95052-8059

Printed: JANUARY 1993

---

MANUAL PART NUMBER 05361-90027



# Certification and Warranty

## CERTIFICATION

*Hewlett-Packard Company certifies that this product met its published specifications at the time of shipment from the factory. Hewlett-Packard further certifies that its calibration measurements are traceable to the United States National Institute of Standards and Technology (formerly National Bureau of Standards), to the extent allowed by that organization's calibration facility, and to the calibration facilities of other International Standards Organization members.*

## WARRANTY

This Hewlett-Packard instrument product is warranted against defects in material and workmanship for a period of one year from date of shipment. During the warranty period, Hewlett-Packard Company will, at its option, either repair or replace products which prove to be defective.

For warranty service or repair, this product must be returned to a service facility designated by HP. Buyer shall prepay shipping charges to HP and HP shall pay shipping charges to return the product to Buyer. However, Buyer shall pay all shipping charges, duties, and taxes for products returned to HP from another country.

HP warrants that its software and firmware designated by HP for use with an instrument will execute its programming instructions when properly installed on that instrument. HP does not warrant that the operation of the instrument, or software, or firmware will be uninterrupted or error free.

## LIMITATION OF WARRANTY

The foregoing warranty shall not apply to defects resulting from improper or inadequate maintenance by Buyer, Buyer-supplied software or interfacing, unauthorized modification or misuse, operation outside of the environmental specifications for the product, or improper site preparation or maintenance.

NO OTHER WARRANTY IS EXPRESSED OR IMPLIED. HP SPECIFICALLY DISCLAIMS THE IMPLIED WARRANTIES OF MERCHANTABILITY AND FITNESS FOR A PARTICULAR PURPOSE.

## EXCLUSIVE REMEDIES

THE REMEDIES PROVIDED HEREIN ARE BUYER'S SOLE AND EXCLUSIVE REMEDIES. HP SHALL NOT BE LIABLE FOR ANY DIRECT, INDIRECT, SPECIAL, INCIDENTAL, OR CONSEQUENTIAL DAMAGES, WHETHER BASED ON CONTRACT, TORT, OR ANY OTHER LEGAL THEORY.

## ASSISTANCE







*Product maintenance agreements and other customer assistance agreements are available for Hewlett-Packard products.*

*For any assistance, contact your nearest Hewlett-Packard Sales and Support Office. Addresses are provided at the back of this manual.*

## Safety Considerations

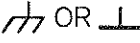
<b>GENERAL</b>	This product and related documentation must be reviewed for familiarization with safety markings and instructions before operation.
<b>BEFORE APPLYING POWER</b>	This product is a Safety Class I instrument (provided with a protective earth terminal). Verify that the product is set to match the available line voltage and the correct fuse is installed. Refer to instructions in this appendix.
<b>SAFETY EARTH GROUND</b>	An uninterruptible safety earth ground must be provided from the mains power source to the product input wiring terminals or supplied power cable.

## Safety Symbols

	Instruction manual symbol; the product will be marked with this symbol when it is necessary for the user to refer to the instruction manual.
	Indicates hazardous voltages.
	Indicates earth (ground) terminal.
 OR 	Indicates terminal is connected to chassis when such connection is not apparent.
	Alternating current.
	Direct current.

### WARNING

THIS DENOTES A HAZARD. IT CALLS ATTENTION TO A PROCEDURE, PRACTICE, OR THE LIKE, WHICH, IF NOT CORRECTLY PERFORMED OR ADHERED TO, COULD RESULT IN PERSONAL INJURY. DO NOT PROCEED BEYOND A **WARNING** SIGN UNTIL THE INDICATED CONDITIONS ARE FULLY UNDERSTOOD AND MET.

### CAUTION

This denotes a hazard. It calls attention to an operating procedure, practice, or the like, which, if not correctly performed or adhered to, could result in damage to or destruction of part or all of the product. Do not proceed beyond a **CAUTION** sign until the indicated conditions are fully understood and met.

## Safety Information

### WARNING

Any interruption of the protective grounding conductor (inside or outside the instrument) or disconnecting the protective earth terminal will cause a potential shock hazard that could result in personal injury. (Grounding one conductor of a two conductor outlet is not sufficient protection.)

Whenever it is likely that the protection has been impaired, the instrument must be made inoperative and be secured against any unintended operation.

If this instrument is to be energized via an autotransformer (for voltage reduction) make sure the common terminal is connected to the earthed pole terminal (neutral) of the power source.

Instructions for adjustments while covers are removed and for servicing are for use by service-trained personnel only. To avoid dangerous electric shock, do not perform such adjustments or servicing unless qualified to do so.

For continued protection against fire, replace the line fuse(s) only with 250V fuse(s) of the same current rating and type (for example, normal blow, time delay). Do not use repaired fuses or short circuited fuseholders.

When measuring power line signals, be extremely careful and always use a step-down isolation transformer whose output voltage is compatible with the input measurement capabilities of this product. This product's front and rear panels are typically at earth ground, so **NEVER TRY TO MEASURE AC POWER LINE SIGNALS WITHOUT AN ISOLATION TRANSFORMER.**

## Safety Information (Continued)

**ACOUSTIC NOISE EMISSION:** LpA 47dB at operator position, at normal operation, tested per ISO 7779. All data are the results from type test.

**GERAeUSCHEMISSION:** LpA 47 dB am Arbeits platz, normaler Betrieb, geprueft nach DIN 45635 Teil 19. Die Angaben beruhen auf Ergebnissen von Typpruefungen.



# Table of Contents

<b>HOW TO USE THIS MANUAL</b>	Introduction ..... 1-1
	Where to Find Major Topics ..... 1-1
	Unpacking the Instrument: ..... 1-1
	Specifications: ..... 1-1
	Operation Verification and Performance Tests: ..... 1-1
	If You Are an Experienced User: ..... 1-1
	If You Are a Novice User: ..... 1-2
	Manual Summary ..... 1-2
	If You Need Service Information: ..... 1-3
	Instruments Covered By This Manual ..... 1-3
	HP 5361A 20 GHz Pulse/CW Microwave Counter ..... 1-4
<b>SECTION 1 STARTING OUT WITH THE HP 5361B</b>	Section Guide ..... 1-1
	Where to Find Important Topics ..... 1-1
	Section Summary ..... 1-1
	Overall Description of the HP 5361B ..... 1-2
	Basic Functions of the HP 5361B ..... 1-4
	Counting Pulses ..... 1-5
	Counting CW Frequency ..... 1-8
	Measurement Modifiers ..... 1-11
	Math Modifiers ..... 1-12
	Extended Functions ..... 1-12
	Quick Reference Guide ..... 1-13
	How To Use the HP 5361B ..... 1-16
	Auto Pulse Profiling ..... 1-16
	VCO Characterization ..... 1-18
	Radar Waveform Frequency Profile Measurements ..... 1-20
	Options ..... 1-22
	Accessories ..... 1-23
	Service Equipment Available ..... 1-24
<b>SECTION 2 FURTHER USE OF THE HP 5361B</b>	Section Guide ..... 2-1
	Where to Find Important Topics ..... 2-1
	Section Summary ..... 2-1
	How Your Measurements Get Customized ..... 2-2
	Overall Description ..... 2-2
	Additional Features ..... 2-3
	Operating Ranges ..... 2-4

**SECTION 2  
FURTHER USE  
OF THE HP 5361B  
(Continued)**

Resolution .....	2-4
Auto Mode .....	2-5
Manual Mode .....	2-5
Internal Gating .....	2-6
External Gating and Arming .....	2-6
Gate Modes .....	2-6
Sample Rate .....	2-6
FM Tolerance (CW only) .....	2-7
FM Rate and Frequency Tracking (CW only) .....	2-7
AM Tolerance (CW only) .....	2-7
Offset Values .....	2-7
Scale .....	2-8
Smooth .....	2-8
Self Check/Cal .....	2-9
Extended Functions .....	2-9
Remote Operation .....	2-9
How Options Expand and Modify	
Measurement Capabilities .....	2-10
Option 001 Oven Oscillator Time Base .....	2-10
Option 006 Limiter .....	2-10
Option 010 High Stability Time Base .....	2-10
Option 026 26.5 GHz Frequency Extension .....	2-10
Option 040 40 GHz Frequency Extension .....	2-11
Option 700 Internal CIIL Interface (MATE) .....	2-11
Using the HP 5361B .....	2-11
Power-up/Warm-up .....	2-11
Operator's Checks .....	2-12
Power-up Self Check .....	2-13
Keyboard Check .....	2-14
Operator's Maintenance .....	2-15
Maximum Input Signal Power .....	2-16
High Frequency Input (Input 1) .....	2-16
Low Frequency Input (Input 2) .....	2-16
Input Cable Considerations .....	2-17
Preliminary Procedures .....	2-17
Detailed Operating Procedures .....	2-18
Entering Parameter Values .....	2-20
Keyboard Memory .....	2-21
Data Entry Considerations .....	2-21
Measurement Modes .....	2-23
Power-up Default Values .....	2-23
Automatic Measurement Mode (Auto) .....	2-23
Manual Measurement Mode (Manual) .....	2-24
Set Manual Center Frequency .....	2-24
Set Manual Center Frequency to Last Measured Frequency .....	2-25

**SECTION 2**  
**FURTHER USE**  
**OF THE HP 5361B**  
*(Continued)*

High/Low Measurement Band Modes (Option 040 Only) .....	2-26
Low Frequency, 50 $\Omega$ Measurement Mode .....	2-27
Low Frequency, 1M $\Omega$ Measurement Mode .....	2-27
Making Pulse Measurements .....	2-28
Pulse Envelope Characteristics and Terminology .....	2-28
Selecting Pulse Measurement Characteristics .....	2-29
Input 1 Pulse Measurements	
(500 MHz – MAX GHz) .....	2-30
Pulse Frequency (FREQUENCY) .....	2-30
Pulse Profile (PROFILE) .....	2-31
Pulse Width (P WIDTH) .....	2-33
Pulse Off Time (OFFTIME) .....	2-34
Pulse Repetition Interval (PRI) .....	2-34
Pulse Repetition Frequency (PRF) .....	2-35
Low Pulse Repetition Frequency Measurement Mode (<50 Hz PRF) .....	2-36
Gating and Arming .....	2-37
Internal Gating .....	2-38
External Gating .....	2-38
Arming .....	2-40
Using Measurement Modifiers .....	2-41
Power-up Default Values: .....	2-42
Resolution .....	2-42
Check Resolution .....	2-42
Set Resolution .....	2-43
High Resolution .....	2-44
Pulse Averaging .....	2-45
Check Pulse Averaging Value .....	2-46
Set a New Pulse Average .....	2-46
Sample Rate .....	2-47
Check Sample Rate .....	2-47
Set a New Sample Rate .....	2-48
Trigger .....	2-49
FM Rate/Track .....	2-49
Math Modifiers .....	2-51
Power-up Default Values .....	2-51
Offset .....	2-51
Turn On Offset .....	2-51
Set a New Offset Value .....	2-52
Set Offset To Last Value .....	2-54
Scale .....	2-55
Turn On Scale Factor .....	2-55
Set a New Scale Factor .....	2-56
Smooth .....	2-57
Turn On Smooth .....	2-57

<p><b>SECTION 2</b>  <b>FURTHER USE</b>  <b>OF THE HP 5361B</b>  <i>(Continued)</i></p>	<p>Extended Functions and HP-IB Configuration ..... 2-58</p> <p>  Calling Extended Functions/Diagnostics ..... 2-58</p> <p>    Turn On Current Extended Function ..... 2-59</p> <p>    Set a New Extended Function Number ..... 2-59</p> <p>    Move to Next Extended Function ..... 2-60</p> <p>    Special Extended Function Exit Procedures .... 2-60</p> <p>  Extended Function Descriptions ..... 2-61</p> <p>    Display IF (EF 02) ..... 2-63</p> <p>    Display MRC E &amp; T Register Contents (EF 03) . 2-63</p> <p>    Display LO (Synthesizer) Frequency (EF 04) ... 2-64</p> <p>    Display Harmonic Number (Integer) and              Sideband (EF 05) ..... 2-64</p> <p>    Display Harmonic Number (Fraction) and              Sideband (EF 06) ..... 2-64</p> <p>    Display Interpolator Short Calibration (EF 07) . 2-65</p> <p>    Display Interpolator Long Calibration (EF 08) . 2-65</p> <p>    Display Interpolator Measurement (EF 09) .... 2-65</p> <p>    Display MRC E &amp; T Register Contents for              Pulse Measurements (EF 33) ..... 2-65</p> <p>    Display Gate Bias Error (EF 34) ..... 2-66</p> <p>    Display ROM Version Number (EF 40) ..... 2-66</p> <p>    LO Synthesizer Verification:</p> <p>      User Entered Frequency (EF 51) ..... 2-66</p> <p>    Gate Bias Calibration (EF 54) ..... 2-68</p> <p>    Disable Hardware and Software IF Detector              Flags: Display Measurement (EF 62) ..... 2-68</p> <p>    Disable Hardware and Software IF Detector              Flags: Display IF (EF 63) ..... 2-68</p> <p>    Disable Software IF Detector Flag: Display              IF (EF 64) ..... 2-69</p> <p>    Display IF Function Status Indicators (EF 66) .. 2-69</p> <p>    Disable IF Detector: Display IF Function Status              Indicators (EF 67) ..... 2-69</p> <p>    Display Narrow Pulse Harmonic              Numbers (EF 68) ..... 2-69</p> <p>    Set Printer Option (EF 72) ..... 2-69</p> <p>    Set PRT Opt (EF 73) ..... 2-70</p> <p>    Set Start Time for Profiling (EF 81) ..... 2-70</p> <p>    Set Stop Time for Profiling (EF 82) ..... 2-71</p> <p>    Set Fine or Coarse Data for Profiling (EF 83) ... 2-71</p> <p>    Set Profiling Output Printer Options (EF 84) ... 2-72</p> <p>    Set Filter On/Off for Profiling Output (EF 85) . 2-73</p> <p>    Enter ID Prefix for Profiling Printer Output              Plot (EF 86) ..... 2-74</p> <p>    Set Number of Data Points (Steps) for              Frequency Profile (EF 87) ..... 2-74</p>
---	---

**SECTION 2**  
**FURTHER USE**  
**OF THE HP 5361B**  
*(Continued)*

Set Start IF Cycle for Frequency Profile (EF 88) .....	2-74
Set Number of IF Cycles Per Step for Profile (EF 89) .....	2-75
Set Gate Width In Time (EF 90) .....	2-75
Set Number of Averages for Frequency Measurement (EF 91) .....	2-75
Force Pulse or CW Measurement Mode (EF 92) .....	2-76
Enter <100NS Pulse Mode (EF 93) .....	2-76
High Resolution (Input 1, PRF/Input 2, 1 M $\Omega$ ) (EF 94) .....	2-77
Set Gate Width By Events (EF 95) .....	2-77
Enter Chirp Mode (EF 96) .....	2-78
Set IF for Manual Center Frequency (EF 97) ...	2-78
Keyboard Lockout (EF 98) .....	2-78
Display Lockout (EF 99) .....	2-79
HP-IB Configuration .....	2-80
How to Display the HP-IB Address .....	2-80
How to Set the HP-IB Address: .....	2-81
What To Do If There Is A Problem .....	2-81
User Problems and Solutions .....	2-81
Power-On Tests .....	2-84
How to Use Self Check .....	2-86
Keyboard Check .....	2-87
Failure and Error Messages .....	2-88
Overflow Warning .....	2-89
Diagnostic Extended Functions .....	2-89
Self Check (EF 1) .....	2-89
Timebase Verification (EF 10) .....	2-91
Power Supply Verification (EF 11) .....	2-91
Low Frequency 50 $\Omega$ Verification:	
35 MHz (EF 20) .....	2-91
Low Frequency 1 M $\Omega$ Verification:	
35 MHz (EF 21) .....	2-92
MRC Channel A Verification: 10 MHz	
Timebase (EF 30) .....	2-92
MRC Channel B Verification: 35 MHz (EF 31) ..	2-92
Interpolator Check (EF 32) .....	2-92
RAM Test (EF 41) .....	2-93
ROM Test (EF 42) .....	2-93
Repeated Reset (EF 43) .....	2-93
LO Synthesizer Verification: 29.5 MHz and	
35 MHz (EF 50) .....	2-94
LO Synthesizer Sweep (EF 52) .....	2-95

**SECTION 2  
FURTHER USE  
OF THE HP 5361B  
(Continued)**

LO Synthesizer Lower, Upper Frequency  
 Bounds (EF 53) ..... 2-95  
 IF Verification: 35 MHz; Disable Input 1 and  
 IF (EF 60) ..... 2-95  
 Check Level Detector (EF 61) ..... 2-96  
 IF Verification: 35 MHz; Disable  
 Input 1 (EF 65) ..... 2-96  
 Keyboard Test (EF 70) ..... 2-97  
 Display Test (EF 71) ..... 2-97  
 HP-IB Verification (EF 80) ..... 2-97

**SECTION 3  
HP 5361B CONTROLS  
AND INDICATORS**

Section Guide ..... 3-1  
 Where to Find Important Topics ..... 3-1  
 Section Summary ..... 3-1  
 Front Panel Features ..... 3-2  
 Keyboard ..... 3-2  
 Key Functions ..... 3-3  
 Power ..... 3-3  
 Reset/Local ..... 3-4  
 Frequency/Profile ..... 3-4  
 P Width/Overtime ..... 3-5  
 PRF/PRI (1/PRF) ..... 3-5  
 Offset ..... 3-6  
 Scale ..... 3-6  
 Smooth ..... 3-7  
 Set/Enter ..... 3-7  
 Resolution ..... 3-7  
 Gate Mode ..... 3-8  
 Extended Function ..... 3-8  
 Sample Rate ..... 3-9  
 HP-IB Address ..... 3-9  
 Self Check/CAL ..... 3-10  
 FM Rate/Track ..... 3-10  
 Trigger ..... 3-11  
 50Ω ..... 3-11  
 1MΩ ..... 3-11  
 Auto ..... 3-11  
 Manual ..... 3-12  
 Front Panel Display and Annunciators ..... 3-13  
 LCD Character Set ..... 3-13  
 Annunciator Descriptions ..... 3-15  
 Front Panel Signal Connectors ..... 3-19  
 INPUT 1 ..... 3-19  
 INPUT 2 ..... 3-19  
 SCOPE-VIEW Output ..... 3-19

**SECTION 3**  
**HP 5361B CONTROLS**  
**AND INDICATORS**  
*(Continued)*

GATE/ARM Input ..... 3-20  
Rear Panel Features ..... 3-21  
AC Power Input Module ..... 3-21  
TCXO Adjustment ..... 3-22  
HP-IB Connector ..... 3-22  
HP-IB Address Switch ..... 3-22  
External Reference In ..... 3-22  
1 MHz Out,  
10 MHz Out ..... 3-22  
IF Out ..... 3-23  
Pulse Out ..... 3-23

**SECTION 4**  
**REMOTE OPERATION**  
**VIA HP-IB**

Section Guide ..... 4-1  
Where to Find Important Topics: ..... 4-1  
Section Summary ..... 4-2  
Selecting the HP-IB Address ..... 4-2  
HP 5361B Interface Capabilities ..... 4-4  
Interface Commands ..... 4-5  
Device Independent Commands ..... 4-6  
Meta Messages ..... 4-7  
Checking Instrument Status ..... 4-9  
Front Panel Instrument Status Annunciators ..... 4-10  
SRQ and Status Byte ..... 4-10  
Service Request Mask ..... 4-11  
Data Input ..... 4-12  
Syntax ..... 4-12  
Command Headers ..... 4-14  
Command Separators ..... 4-16  
Data Separators ..... 4-16  
Data Formats ..... 4-16  
Numeric Data  
(NR1, NR2, NR3) ..... 4-17  
Character Data ..... 4-18  
String Data ..... 4-19  
Value Specifier ..... 4-19  
Data Output ..... 4-19  
Measurement Output Formats ..... 4-19  
Extended Function and Diagnostic Results ..... 4-20  
Other Outputs ..... 4-20  
Numeric Output Format ..... 4-20  
Measurement Data Field ..... 4-21  
Exponent ..... 4-21  
Typical Output Strings ..... 4-21  
Query Output Format ..... 4-22  
Error Handling ..... 4-22

<p><b>SECTION 4</b>  <b>REMOTE OPERATION</b>  <b>VIA HP-IB</b>  <i>(Continued)</i></p>	<p>HP-IB Command Descriptions . . . . . 4-23</p> <p>AUTO - Automatic Acquisition Mode . . . . . 4-23</p> <p>AVER - Average Measurement Modifier . . . . . 4-24</p> <p>CHIRP - Chirp Mode . . . . . 4-24</p> <p>CLR - Instrument Clear . . . . . 4-24</p> <p>DATAPTS - Data Points . . . . . 4-24</p> <p>DISPLAY - Display Message/Conceal Message . . . . . 4-25</p> <p>DUMP - Take Fastest Measurements . . . . . 4-26</p> <p>EDELTA - Event Delta . . . . . 4-27</p> <p>EFUN - Extended Function . . . . . 4-27</p> <p>EFUNPARAM - Extended Function Parameter . . . . . 4-28</p> <p>EFUN? - Send Extended Function Result . . . . . 4-28</p> <p>ERR? - Send Error Number . . . . . 4-28</p> <p>ESTART - Event Start . . . . . 4-29</p> <p>FINE - Fine/Coarse Data . . . . . 4-29</p> <p>FMRATE - FM Rate/Track . . . . . 4-30</p> <p>FREQ - Frequency . . . . . 4-30</p> <p>FREQBAND? - Send Frequency Band          (Option 040 Only) . . . . . 4-30</p> <p>FUNC? - Send Current Pulse/CW Function(s) . . . . . 4-30</p> <p>GATE - Gate Mode . . . . . 4-31</p> <p>GWID - Set Gate Width . . . . . 4-31</p> <p>HARM? - Send Harmonic Number . . . . . 4-32</p> <p>HARMDET - Harmonic Number Determination . . . . . 4-32</p> <p>HIGHBAND - Set High Frequency Band          (Option 040 Only) . . . . . 4-32</p> <p>HIGHZ - INPUT 2, 1 M<math>\Omega</math> . . . . . 4-33</p> <p>HIRESOL - High Resolution . . . . . 4-33</p> <p>ID? - Send Identity . . . . . 4-33</p> <p>IFPER? - Send IF Periods Per Step . . . . . 4-34</p> <p>INIT - Initialize Instrument . . . . . 4-34</p> <p>KEY? - Send Number of Last Key Pressed . . . . . 4-34</p> <p>LOWBAND - Set Low Frequency Band          (Option 040 Only) . . . . . 4-35</p> <p>LOWZ - INPUT 2, 50<math>\Omega</math> . . . . . 4-35</p> <p>LO? - Send LO Frequency . . . . . 4-36</p> <p>LPRF - Low Pulse Repetition Frequency . . . . . 4-36</p> <p>MANUAL - INPUT 1, Manual Mode . . . . . 4-36</p> <p>MMOD - Set Measurement Mode . . . . . 4-36</p> <p>NPUL - Narrow Pulse Mode . . . . . 4-37</p> <p>OFFSET - Offset . . . . . 4-37</p> <p>OFFT - Pulse Off Time . . . . . 4-37</p> <p>OVEN? - Send Oven Status . . . . . 4-38</p> <p>PAVER - Pulse Averaging . . . . . 4-38</p> <p>PRF - Pulse Repetition Frequency . . . . . 4-38</p> <p>PRI - Pulse Repetition Interval . . . . . 4-39</p>
--	---



**SECTION 4**  
**REMOTE OPERATION**  
**VIA HP-IB**  
*(Continued)*

PROF - Profile Frequency ..... 4-39  
 PROFAVG? - Send Profile Number of Averages ..... 4-40  
 PROFTIME - Profile Time Data ..... 4-40  
 PWID - Pulse Width ..... 4-41  
 REF? - Send Time Base Reference Status ..... 4-41  
 RESET - Restart Measurement ..... 4-41  
 RESOL - Resolution ..... 4-41  
 REV? - Send Firmware Revision Date Code ..... 4-42  
 SAMPLE - Sample Rate ..... 4-42  
 SCALE - Scale ..... 4-42  
 SER? - Send Serial Number ..... 4-43  
 SET - Accept Instrument Setup ..... 4-43  
 SET? - Send Instrument Setup ..... 4-43  
 SETIF - Set IF For Manual Frequency ..... 4-44  
 SIDEBAND? - Send Sideband Position ..... 4-44  
 SLEEP - Low Emissions Mode ..... 4-44  
 SMOOTH - Smooth ..... 4-44  
 SRQMASK - Service Request Mask ..... 4-45  
 TEST? - Send Self Check Results ..... 4-45  
 TFINAL - Set Profile Stop Time ..... 4-46  
 TRG, TRIGGER - Trigger ..... 4-46  
 TSTART - Set Profile Start Time ..... 4-47  
 Programming Examples ..... 4-48

**APPENDIX A**  
**SPECIFICATIONS**

Appendix Guide ..... A-1

**APPENDIX B**  
**INSTALLATION**

Appendix Guide ..... B-1  
 Where to Find Important Topics ..... B-1  
 Appendix Summary ..... B-1  
 Initial Inspection ..... B-2  
 Preparation for Use ..... B-2  
 Power Requirements ..... B-2  
 Line Voltage and Fuse Selection ..... B-2  
 Power Cable ..... B-4  
 Operating Environment ..... B-6  
 Hewlett-Packard Interface Bus ..... B-6  
 HP-IB Interconnections ..... B-6  
 Cable Length Restrictions ..... B-8  
 HP-IB Talk/Listen Address ..... B-8  
 HP-IB Description ..... B-8  
 Storage and Shipment ..... B-8  
 Environment ..... B-8  
 Packaging ..... B-9  
 Operator's Maintenance ..... B-9

<p><b>APPENDIX B</b>  <b>INSTALLATION</b>  <i>(Continued)</i></p>	<p>Field Installation of Options .....B-10                  Installation of Option 001 or Option 010 Time Base ...B-11                  Installation of Option 006 Limiter .....B-12</p>
<p><b>APPENDIX C</b>  <b>PERFORMANCE TESTS</b></p>	<p>Appendix Guide ..... C-1                  Where to Find Important Topics ..... C-1                  Appendix Summary ..... C-1                  Operation Verification ..... C-2                  HP-IB Verification ..... C-2                  Complete Performance Testing ..... C-2                  Equipment Required ..... C-2                  Calibration Cycle ..... C-4                      Test Specifications with Option 006 ..... C-4                  Operation Verification Procedure ..... C-4                      Power-Up Self Check ..... C-4                      Input 2, CW Counting Check ..... C-5                      Input 2, 10 Hz - 525 MHz CW Input                          Sensitivity Test ..... C-5                      Input 1, 500 MHz - MAX GHz CW Input                          Sensitivity Test ..... C-7                      Input 1, 500 MHz - MAX GHz Pulse Input                          Sensitivity Test ..... C-9                      Input 1 Pulsed RF Sensitivity Test                          (500 MHz - MAX GHz) ..... C-10                  HP-IB Verification ..... C-12                  Performance Test Procedures ..... C-19                      Input 2, 10 Hz - 525 MHz CW Input                          Sensitivity Test ..... C-19                      Input 1, 500 MHz - MAX GHz CW Input                          Sensitivity Test ..... C-20                      Input 1, 500 MHz - MAX GHz Pulse Input                          Sensitivity Test ..... C-21                      Input 1 Pulsed Rf Sensitivity Test                          (500 MHz - MAX GHz) ..... C-22                          Pulse Frequency Profile ..... C-24                          FM Tolerance Test (CW Only) ..... C-25                      Input 1 Pulse Width/Repetition Frequency Test .... C-27                          Auto Mode, 100 ns, 2 MHz PRF ..... C-27                          Manual Mode, 90 ns, 2 MHz PRF ..... C-28                          Auto Mode, 2 ms, 50 Hz PRF ..... C-29                      External Gate/Arm In Test ..... C-30                      External Gate Mode Test ..... C-32                      HP 9000 Program Listing ..... C-36</p>

<b>APPENDIX D ADVANCED MEASUREMENTS AND PROFILING</b>	Appendix Guide .....	D-1
	Where to Find Important Topics .....	D-1
	Appendix Summary .....	D-1
	Why You May Need External Gating or Arming .....	D-2
	Gating vs Arming .....	D-2
	The Scope-View Output .....	D-2
	External Gating Details .....	D-2
	Connecting the External Gate Signal .....	D-3
	Timing the External Gate Signal .....	D-3
	Gate Width vs Accuracy .....	D-5
	Other Considerations .....	D-5
	External Arming Details .....	D-6
	Connecting the External Arm Signal .....	D-6
	Timing the External Arming Signal .....	D-6
	Chirped Pulse Measurements Using Extended Function 96 .....	D-6
	Pulse/CW Frequency Profiling .....	D-7
	Setting Up For Profiling .....	D-8
	Turning On the Profiling Function .....	D-8
	Interpreting Printed Hardcopy Results .....	D-9
	Modifying the Measurement .....	D-12
	Resolution .....	D-12
	Set Start Time .....	D-12
	Set Stop Time .....	D-12
	Number Of Data Points .....	D-13
	Output Control .....	D-13
	Filter .....	D-13
	Plot ID Prefix .....	D-14
	Full Manual Control .....	D-14
	Customizing The Default Settings .....	D-15
	Set Number of Data Points .....	D-16
	Set Start IF Cycle .....	D-16
	Set Number of IF Cycles Per Step .....	D-16
	Output Table Format .....	D-16
Making a "Spot Frequency" Measurement Within the Pulse Burst .....	D-18	
Pulse/CW Phase Profiling .....	D-18	
Obtaining The Output .....	D-19	
Interpreting The Output .....	D-19	
Other Data For Phase .....	D-19	



# HOW TO USE THIS MANUAL

---

## **INTRODUCTION**

This Operating and Programming Manual provides the information that you need to install, operate, and program the HP 5361B Microwave Frequency Pulse Counter. This brief section, How to Use This Manual, provides a short summary of the manual contents, and describes how to identify which version of the HP 5361B is described by your edition of this manual.

## **WHERE TO FIND MAJOR TOPICS**

This manual is organized into four sections and four appendixes. A task-oriented design is present that puts material about routine operation at the front of the book. Less frequently used information has been placed in the appendixes or appears further into the manual. An index has also been provided to help you locate specific information quickly. The following paragraphs provide a brief guide to help you find the information needed to unpack, test, and begin using your HP 5361B.

A manual summary is also provided to give you an overall view of where topics are located in the manual.

### **Unpacking the Instrument:**

Refer to Appendix B for all unpacking, installation, and maintenance procedures.

### **Specifications:**

All HP 5361B specifications are located in Appendix A.

### **Operation Verification and Performance Tests:**

Refer to Appendix C when you need to check the HP 5361B for correct operation. You can perform the procedures in this appendix to ensure that the instrument functioning according to the specifications listed in Appendix A.

### **If You Are an Experienced User:**

If you have experience taking microwave CW and Pulse measurements, you may wish to briefly scan Section 3, HP 5361B Controls and Indicators, to locate front panel controls and inputs. You should also look through Section 1, Starting Out With the HP 5361B, for a short hands-on tour that includes basic operating procedures, a key sequence summary, and sample applications with measurement setups.

After becoming familiar with the front panel features, you can read Section 2, Further Use of the HP 5361B, for more information about operating characteristics and tutorial procedures for Pulse and CW measurements. Section 2 also provides the details of such things as math modifiers and Gating/Arming and ends with information for solving simple operating problems.

If you are familiar with the Hewlett-Packard Interface Bus (HP-IB), refer to Section 4 for information about remote operation of the HP 5361B.

**If You Are a  
Novice User:**

If you are new to microwave counters and measurements, you should read (in order) Sections 1, 2, and 3 to get a better understanding of how to use the HP 5361B before you begin making measurements. Refer to the manual summary below for a description of the contents of this manual.

**MANUAL  
SUMMARY**

This manual is arranged to cover the following major topics:

**SECTION 1 — STARTING OUT WITH THE HP 5361B** Provides you with a brief description of main features and functions followed by a quick hands-on tour of a few ways the HP 5361B can be used. Basic use of the instrument is explained in this section for Pulse, CW, and Profile measurements. Options and accessories are also mentioned here.

**SECTION 2 — FURTHER USE OF THE HP 5361B** Provides more detailed information about such things as math modifiers, gating/arming, measurement modes and extended functions. Tutorial procedures for Pulse and CW measurements also appear in this section along with a description of the overall operating characteristics of the instrument. If you encounter a problem while trying to use the instrument, refer to the problem-solving procedures located at the end of this section.

**SECTION 3 — HP 5361B CONTROLS AND INDICATORS** Provides brief explanations of all front and rear panel controls, indicators, and connections.

**SECTION 4 — REMOTE OPERATION VIA HP-IB** Describes the HP-IB capabilities of the instrument and contains a complete description of all HP-IB commands for programming the instrument. Also included is information about data

output format, instrument status and service request capabilities, and programming examples.

**APPENDIX A — SPECIFICATIONS** Contains the specifications for the HP 5361B. These specifications are the performance standards or limits against which the instrument can be tested.

**APPENDIX B — INSTALLATION** Contains information about unpacking, initial inspection, preparation for use, storage, and operator's maintenance of the instrument. At the end of this section are procedures for field installation of instrument options.

**APPENDIX C — PERFORMANCE TESTS** Describes procedures for testing the electrical performance of the HP 5361B using the specifications in Appendix A as performance standards.

**APPENDIX D — ADVANCED MEASUREMENTS AND PROFILING** Provides more detailed information on how external gating, arming, and chirped radar pulse measurements are made. Additional information about frequency and phase profiling measurement is also included.

**If You Need Service  
Information:**

For service information, refer to the HP 5361B Service Manual (HP Part Number 05361-90003).

**INSTRUMENTS  
COVERED BY THIS  
MANUAL**

The contents of this manual apply to HP 5361B instruments with the serial number prefix(es) listed under SERIAL NUMBERS on the title page. The instrument serial number is located in the upper right corner of the rear panel and is in the form: 0000A00000. The first four numbers and the letter are the serial number prefix. The last five numbers are the suffix. The prefix is the same for all identical HP 5361B instruments; it changes only when a change is made to the instrument. The suffix, however, is assigned sequentially and is different for each individual instrument.

An instrument manufactured after the printing of this manual may have a serial number prefix that is not listed on the title page. This unlisted serial number indicates that the instrument is different from that documented in this manual. The manual for a newer instrument will be accompanied by a Manual Updating Changes supplement. This supplement contains

information that explains how to adapt the manual to the newer instrument.

In addition to change information, the supplement may contain information for correcting errors in the manual. To keep this manual as current and accurate as possible, you should periodically request the latest Manual Updating Changes supplement, available free from Hewlett-Packard. The supplement for this manual is identified by the manual print date and part number, both of which appear on the title page of this manual.

For information concerning a serial number prefix that is not listed on the title page or in the Manual Updating Changes supplement, contact your nearest Hewlett-Packard office. Addresses and phone numbers of HP Sales and Support offices are located at the back of this manual.

**HP 5361A 20 GHz  
Pulse/CW Microwave  
Counter**

The operating and HP-IB programming information contained in this manual is inclusive of all measurement functions present within the HP 5361A product and documents these functions with the exception of the following:

- a. Frequency extension to either 26.5 or 40 GHz and any operating procedures related to measurement of frequencies beyond 20 GHz.
- b. Auto Pulse/CW Profile function (Frequency profiling) and any related operating procedures, test setups, Extended functions, and HP-IB commands used to support this function.
- c. Phase profiling measurement procedures and any related test setups, extended functions, or HP-IB commands used to support this measurement process.

If an HP 5361A is requested to execute either an extended function or HP-IB command found only on the HP 5361B, then the following message will be displayed: "NOT AVAILABLE EFUN nn" for extended functions, and "SYNTAX 4 ERROR" for HP-IB commands.



# STARTING OUT WITH THE HP 5361B

---

**SECTION GUIDE** This section provides an overview of the HP 5361B Pulse/CW Microwave counter, and a hands-on tour of its basic functions. Also present are a simplified block diagram, some basic measurement applications, Quick Reference Guide, and information about options and service.

## Where to Find Important Topics

- What is the HP 5361B? pg. 1-2
- Before You Turn-On the Counter pg. 1-5
- Quick-Tour of the HP 5361B pg. 1-5
- Making Pulse Measurements pg. 1-5
- Making CW Measurements pg. 1-8
- Example Test Set-up pg. 1-18, 1-19, 1-21

## Section Summary

- Overall Description of the HP 5361B pg. 1-2
- Basic Functions of the HP 5361B pg. 1-4
- How to Use the HP 5361B pg. 1-16
- Options and Accessories pg. 1-22
- Service Equipment Available pg. 1-23

**OVERALL  
DESCRIPTION OF  
THE HP 5361B**

The HP 5361B is a Pulse/CW microwave counter with a measurement range of 10 Hz to MAX GHz (20, 26.5, or 40 GHz). Pulse measurements are made between 500 MHz and MAX GHz. The counter automatically measures the frequency of either pulsed or continuous (CW) microwave signals. Automatic frequency and frequency profile, measurements can be made on pulsed signals as narrow as 100 nanoseconds. In addition, frequency, width, and period measurements can be made on the pulse envelope.

The 5361B gives you high performance pulse/CW microwave measurements along with simple, easy-to-use operating procedures. The HP 5361B is controlled by a single microprocessor that commands the counting circuitry (and optional printer). Microprocessor commands generate data, compute measurements, perform various measurement data manipulations and display (or print/plot) measurement results.

You can select all measurement modes and functions via 20 pushbutton keys on the front panel. Selectable functions include pulse functions, measurement modifiers, math modifiers, and alternate internal or external gating for pulse or CW data. (See Appendix D for information about complex externally gated/armed, or frequency/phase profile measurements.)

Additional power and convenience are provided by user-callable extended functions that you can use for increased control to obtain more measurement information. A subset of the extended functions provide powerful diagnostics if the need for instrument testing should ever arise. The counter is equipped with memory to save some of the front panel setup parameters while in the Standby mode.

All display functions are performed by a Liquid Crystal Display, that contains 24 alphanumeric characters (excluding function annunciators) for display of both messages and measurement data.

Full HP-IB programmability is a standard feature of the HP 5361B Pulse/CW Microwave Counter. The Hewlett-Packard Interface Bus provides remote control of measurement functions and data output. All front panel features except for power ON/STBY are available via the HP-IB. Refer to Section 4 of this manual for more information about remote operation via HP-IB. The HP-IB can also be used

to output frequency profile results to an optional printer in either graphic or tabular format.

Figure 1-1 is a simplified block diagram of the HP 5361B. Pulse and CW signals between 500 MHz and MAX GHz (INPUT 1) are down-converted using the HP Harmonic Heterodyne conversion technique. The resulting IF signal is first amplified and filtered. It is then detected, gated, and counted under control of the on-board microprocessor. CW inputs between 10 Hz and 525 MHz (INPUT 2) are prescaled (if necessary) and then counted directly without IF conversion.

Three useful signal connections are also provided. They are: front panel GATE/ARM input, SCOPE-VIEW output, and rear panel Pulse output. Refer to Section 2 and Appendix D of this manual for more detailed theory of operation.

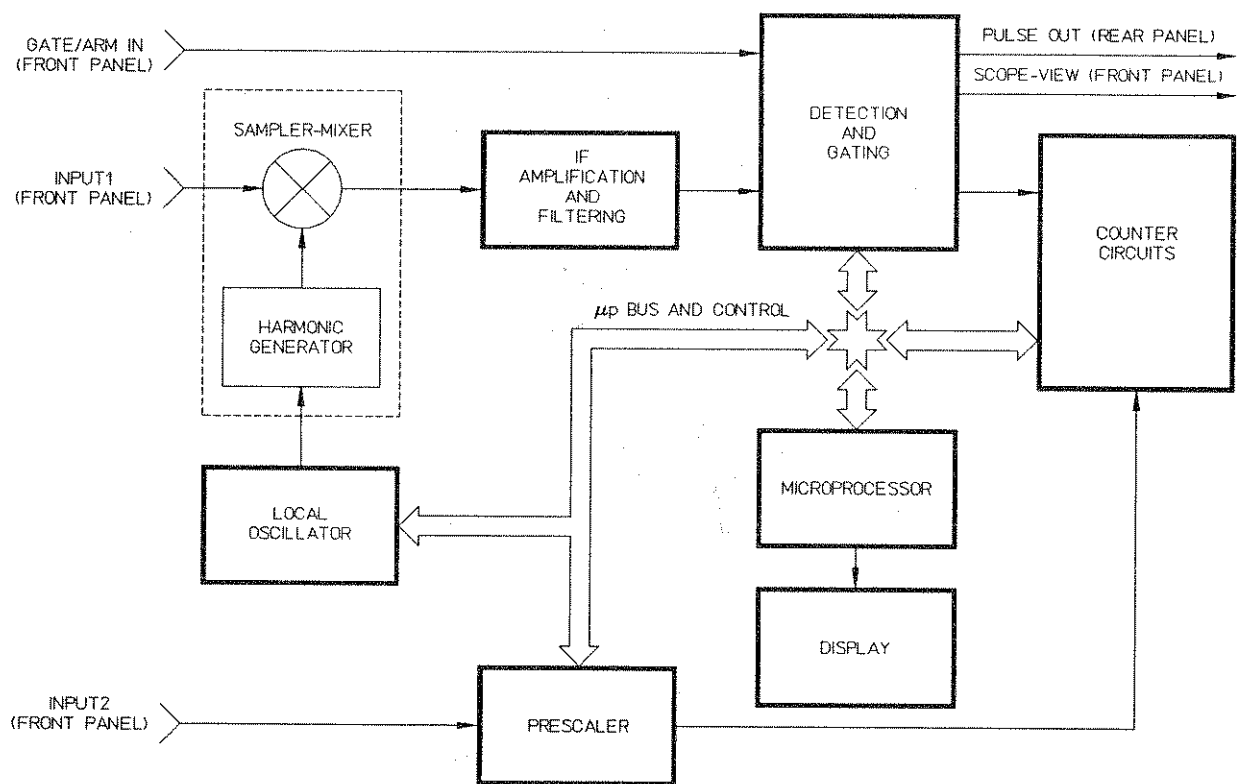

Figure 1-1. HP 5361B Simplified High-level Block Diagram

## BASIC FUNCTIONS OF THE HP 5361B

This is the beginning of your hands-on tour of the HP 5361B Pulse/CW Microwave counter. First, the highlights of the instrument, then, everything you ever wanted to know about the ease and convenience of Pulsed/CW microwave measurements. The main purpose of the HP 5361B is to count the frequency within microwave pulse bursts. You can tell the counter to give you six types of pulse measurements:

- FREQUENCY — carrier frequency of the pulse
- PROFILE — frequency modulation profile of the pulse
- P WIDTH — time duration of the pulse
- OFFTIME — time duration between the end of a pulse and onset of another
- PRF — repetition frequency of the pulse
- PRI — time duration between the onset of a pulse and the onset of another

The HP 5361B is also a powerful CW microwave counter that can automatically acquire, measure, and customize information to suit your particular measurement needs. In addition to the pulse modes mentioned above, this instrument can perform the following for Pulse and CW measurements:

- Automatic or Manual determination of Pulse/CW signal type
- Automatic or Manual acquisition of RF signal
- Selectable INPUT 1 High/Low frequency bands for signal acquisition (Option 040 only)
- Selectable Pulse parameter Averaging — 2 to 9,999 pulses
- Math Modification — Offset ( $\pm$ ), Scaling ( $\times/\div$ ), and Smooth capabilities
- Sample Rate Modification — Variable time duration between measurements
- Gate Mode Selection — External, Arm, and Internal modes
- FM Tolerance Selection — Normal, Low, and Track (INPUT 1, CW only)

- Selectable 50 $\Omega$  or 1 M $\Omega$  inputs for CW signals present at INPUT 2
- Extended function calls provide — control of internal gate width, LO frequency, High Resolution, and others

Those are the features, now for your guided tour:

**BE SURE TO READ THE FOLLOWING IMPORTANT AC POWER/INPUT 1 INFORMATION**

If you haven't done so already, unpack your new HP 5361B and check these important items!

1. Ensure that the enclosed power cable has the correct plug for your ac power source outlet and voltage.
2. Ensure that the printed-circuit line voltage selector card located in the power module is set for your ac power source voltage. Refer to Appendix B, "Line Voltage and Fuse Selection".
3. Ensure that the correct fuse is present in the power module. Refer to Appendix B, as above.
4. Plug the ac power cable into an outlet or extension cord that provides a third wire to protective earth ground.
5. Set the front panel power switch to on.
6. Observe the HP 5361B cycle successfully through all Calibration and Self Check subroutines and then initialize into the Automatic measurement mode.
7. If step six isn't successful, go to the "What to do if There is a Problem" subsection at the end of Section 2.
8. Before you connect an active microwave source to INPUT 1, be sure its power doesn't exceed +7 dBm and always observe Electrostatic Discharge precautions whenever in close proximity to the exposed center conductor of INPUT 1.

## Counting Pulses

OK! You've powered-up the HP 5361B, passed calibration and self check, and you're ready to make a measurement. Let's assume you have a pulsed microwave signal source available

through a cable on your test bench. You'll need a Type N Male or APC 3.5 Female connector to correctly connect it to INPUT 1.

Follow the steps below and refer to *Figure 1-2*. Front Panel Control and Input (Pulse Measurements). (More keystroke sequence information is available in *Table 1-1*. Quick Reference Guide.)

- | Step | Action or Result  |
|------|---|
| 1.   | Connect the signal source cable to INPUT 1.   |
| 2.   | Observe the displayed pulse carrier frequency and "PULSE" message.  |
| 3.   | Press the second (middle) function key "P WIDTH/OFFTIME" once, located on the left side of the front panel. Watch for the following response: <ol style="list-style-type: none"><li>Display shows "PULSE WIDTH" momentarily (or as long as the key is depressed).</li><li>Next, the measurement value appears with the letters "PW" at right.</li></ol> |
| 4.   | Press this key again and see what happens: <ol style="list-style-type: none"><li>Display shows "PULSE OFF TIME" momentarily as in step 3-a.</li><li>Next, the measurement value appears with the letters "OFF" at right.</li></ol>  |
| 5.   | Now press the bottom function key "PRF/PRI (1/PRF)" once, watch what happens: <ol style="list-style-type: none"><li>Display shows "PULSE REP FREQ" momentarily as in steps 3 and 4.</li><li>Next, the measurement value appears with the letters "PRF" at right.</li></ol>  |

6. Press this key again and watch the results:
  - a. Display shows "PULSE REP INTERVAL" momentarily as in step 5.
  - b. Next, the measurement value appears with the letters "PRI" at right.
7. Now you've already made five separate microwave pulse measurements! But just in case you need the first one, press the top function key "FREQUENCY/PROFILE" once ONLY:
  - a. Display shows "FREQUENCY MEASUREMENT" similar to the other keys.
  - b. Once again, the measurement value appears this time with "PULSE" at right.

The steps you just went through show how the HP 5361B quickly, easily, and AUTOMATICALLY gave you the information you needed.

You can also tell the counter to look at a specific center frequency (CF). Refer to the fifth task of the Quick Reference Guide (*Table 1-1*) for the keys to press.

---

**NOTE**

*If the PRF of the input signal is less than 50 Hz, an erroneous measurement may be displayed. Enter the <50 Hz Pulse mode by first entering the MANUAL Mode, then press "Set/Enter" then "PRF". Exit the <50 Hz Pulse mode by pressing "Set/Enter" then "PRF" again.*

*When measuring the frequency of a Chirped radar-pulse you must use extended function 96 (refer to pages 2-78 and D-6 for more information).*

*Depending on the input PRF, there may be a moderate IF AGC settling time.*

---

The next procedure shows you how to count CW frequencies from 10 Hz to MAX GHz.

**STEPS**

- ① CONNECT INPUT SIGNAL
- ② OBSERVE DISPLAY
- ③, ④ SELECT P WIDTH OR OFFTIME
- ⑤, ⑥ SELECT PRI AND PRF
- ⑦ SELECT FREQUENCY

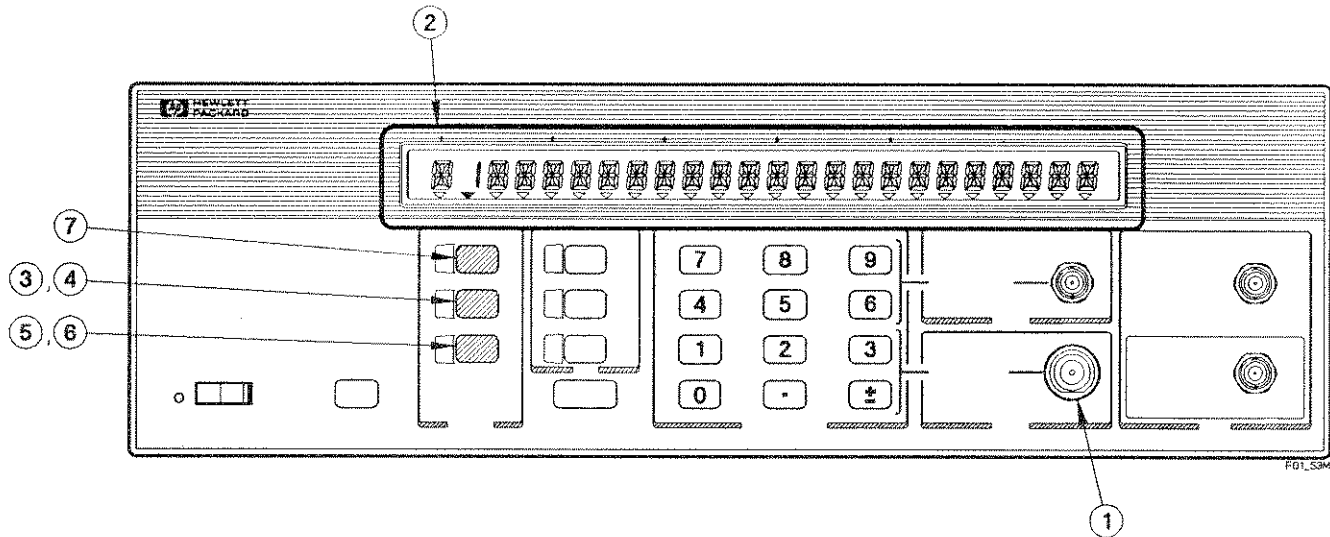

Figure 1-2. Front Panel Control and Input (Pulse Measurements)

**Counting CW Frequency**

With the HP 5361B powered-on, you're ready to make a CW measurement. You'll need a microwave signal source as before only this time it should be CW. Remember that although CW frequencies can be measured from 10 Hz to MAX GHz, two separate signal inputs (1 and 2) are needed to cover this range.

INPUT 1 covers frequencies from 500 MHz to MAX GHz.  
 INPUT 2 handles frequencies from 10 Hz to 525 MHz. Use a Type N Male or APC 3.5 Female connector to properly connect to INPUT 1 and a Male BNC connector for INPUT 2.



We'll use INPUT 1 first then INPUT 2. Follow the steps below and refer to *Figure 1-3, Front Panel Control and Input (CW Measurements)*. (More keystroke sequence information is available in *Table 1-1, Quick Reference Guide*.)

Step	Action or Result
1.	Connect the 500 MHz to MAX GHz signal source to INPUT 1.
2.	Observe the displayed carrier frequency.
3.	If you'd like to "customize" this measurement refer to the second page of <i>Table 1-1, Quick Reference Guide</i> , to make math/measurement modifications or use extended functions.
4.	Disconnect INPUT 1 and connect the 10 Hz to 525 MHz signal source to INPUT 2 and make the following selection: <ol style="list-style-type: none"><li>If the frequency at INPUT 2 is between 10 MHz and 525 MHz, you can press the 50<math>\Omega</math> key to the left of INPUT 2 for proper signal termination.</li><li>If the frequency at INPUT 2 is between 10 Hz and 80 MHz, you can press the 1 M<math>\Omega</math> key to the left of INPUT 2 for proper signal termination.</li></ol>

---

**NOTE**

*If the signal is between 80 MHz and 500 MHz, the 50 $\Omega$  key MUST be pressed for correct operation.*

*If the signal is between 10 Hz and 10 MHz, the 1 M $\Omega$  key MUST be pressed for correct operation.*

---

5. Observe the displayed carrier frequency.
6. If you'd like to "customize" this measurement refer to the second page of *Table 1-1, Quick Reference Guide*, to make math/measurement modifications or use extended functions.

The steps you just went through show how easy it is to make CW frequency measurements using either inputs 1 or 2.

As with pulse measurements, you can ask the counter to look at a specific center frequency (CF). Refer to the fifth task of the Quick Reference Guide (Table 1-1.) for the keys to press.

**STEPS**

- ① CONNECT 500MHz-MAX GHz SIGNAL TO INPUT 1
- ②, ⑤ OBSERVE DISPLAY
- ④ CONNECT 10Hz-525MHz SIGNAL TO INPUT 2
- ④a SELECT 50Ω SIGNAL TERMINATION
- ④b SELECT 1MΩ SIGNAL TERMINATION

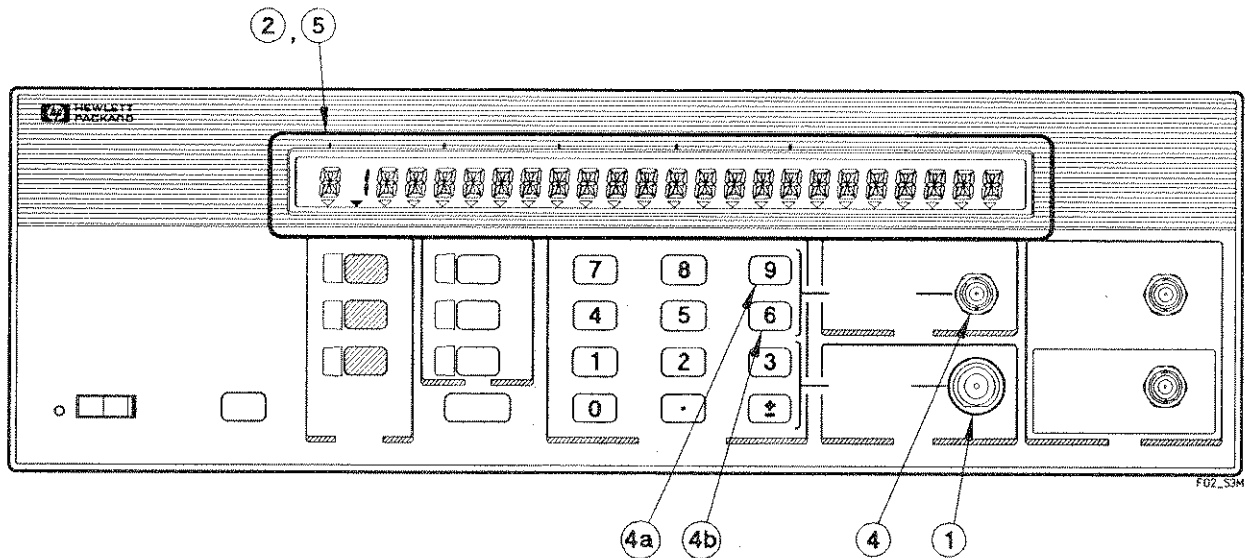

Figure 1-3. Front Panel Control and Input (CW Measurements)

## Measurement Modifiers

Measurement modifiers let you control how the HP 5361B “looks” at the incoming signal and how measurement results are displayed. There are five front panel keys (other than math functions) that let you customize Pulse/CW measurements. They are located on the front panel in the “Control/Data” key group.

The key functions are explained briefly here so you’ll know what they can do. More detailed information about these keys is provided in the next section of this manual. You can also refer to the middle of the second page of the Quick Reference Guide, *Table 1-1*, for the keystrokes to use.

- **RESOLUTION** — This key lets you control the number of digits that appear on the display. User-selected resolution is represented by the least significant digit (LSD) in the display.
- **GATE MODE** — You can change the way Pulse or CW signals are “gated” prior to being measured by using this key. The key cycles through three different gate modes: Arm, External, and Internal.
- **SAMPLE RATE** — This key lets you control the rate at which measurements are made from either input connector. You can chose eight different rates from Fast to Hold.
- **TRIGGER** — Press this key when the Sample Rate is set to hold and you want to make a measurement or frequency profile at a specific moment.
- **FM RATE/TRACK** — This key lets you measure FM CW signals over a wide range of FM rates. The key cycles through three FM modulation ranges: Normal, Low, and Track.

**NOTE**

---

The HP 5361B counter can be “Reset” or “Preset” depending on whether you want to simply abort the current measurement task or abort measurement and return the front panel setup parameters to their default values.

To abort the current measurement (Reset), press the “Reset/Local” key.

To abort the current measurement and return to default setup values (Preset), press “Set/Enter”, then “Reset/Local”.

---

**Math Modifiers**

Math modifiers let you perform all four arithmetic operations on the measurement results. An additional math function “smooth” makes displayed results easier to read. There are three front panel keys you can use to perform math operations. They are located in the “Math” key group.

The key functions are explained briefly here so you’ll know what they can do. More detailed information about these keys is provided in the next section of this manual. You can also refer to the middle of the second page of the Quick Reference Guide, *Table 1-1*, for the keystrokes you’ll need to use.

- **OFFSET** — You can use this key to add or subtract an offset value to/from the calculated results that would normally appear on the display.
- **SCALE** — This key lets you multiply (or simulate division of) the calculated results by a selected multiplier. To multiply, use a whole or mixed decimal number. To “simulate” division, use a decimal fraction.
- **SMOOTH** — Press this key when the least significant digits of a displayed measurement appear unstable and cannot be read.

**Extended Functions**

Extended functions let you get more information about how the HP 5361B generates its measurements or permit you to run diagnostic tests. Some of these function calls can display or let

you change the values of certain internal parameters that were used to make a specific measurement. You can use them to select and input a more "Customized" measurement setup.

You may need this kind of information for those tasks that require an exact account of how the results were calculated. Refer to the second page of the Quick Reference Guide, *Table 1-1*, for some useful extended functions and the keystrokes needed to call them. More detailed explanations of all extended functions are provided in the next section of this manual.

## Quick Reference Guide

Pages 1-14 and 1-15 provide you with the HP 5361B Quick Reference Guide. The guide is organized into five blocks: Basic Pulse/CW Measurements for INPUT 1, Basic CW Measurements for INPUT 2, Frequency Profile for INPUT 1, Customizing Measurements on INPUT 1, and Extended Function Entry.

- The first block shows you exactly how to control the counter to perform its main measurement functions via INPUT 1.
- The second block shows the keys used to make CW measurements between 10 Hz and 525 MHz via INPUT 2.
- The third block shows you how to set up the counter to make a CW sweep or pulse frequency profile. (This procedure requires the use of an optional printer.)
- The fourth block shows you how to customize measurements on INPUT 1.
- The fifth block lists some useful extended functions and their associated numbers.

Table 1-1. Quick Reference Guide

### Basic Pulse/CW Measurements for INPUT 1

TO DO THIS TASK:	PUSH THESE BUTTONS:	AND MEASURE THIS SIGNAL PARAMETER:
Measure PULSE REPETITION FREQUENCY or INTERVAL (Toggle Function)	<b>PRF/PRI</b>	PRF/PRI
Measure PULSE WIDTH or OFFTIME (Toggle Function)	<b>PWIDTH/OFFTIME</b>	PULSE WIDTH / PULSE OFFTIME
Measure PULSE/CW FREQUENCY or make a FREQUENCY PROFILE (Toggle Function)	<b>FREQUENCY/PROFILE</b>	
(CW sweep frequency profile requires you to provide an external gate signal)		
Setting an EXTERNAL GATE or ARM	<b>GATE MODE</b>	<p>External Gate: Positive edge (gate close) must occur when signal is present</p> <p>External Arm: Negative edge must occur during offtime</p>
Change GATE MODE (Cycle through arm, external and internal modes)	<b>GATE MODE</b>	
Set Center Frequency	<b>SET/ENTER</b> <b>MANUAL</b> <b>LST VAL</b> <b>SET/ENTER</b> <b>0-9</b> <b>GHz</b>	
Switch Frequency Bands (Option 040 Only) (Toggle Function)	<b>SET/ENTER</b> <b>FREQUENCY</b>	(500 MHz → 29 GHz) Lo-Band or (12 GHz → 40 GHz) Hi-Band

### Basic CW Measurements for INPUT 2

Measure CW FREQUENCY between 10 Hz and 80 MHz	<b>1MΩ</b>	
Measure CW FREQUENCY between 10 MHz and 525 MHz	<b>50Ω</b>	
<b>NOTES:</b> For All Pulse and CW Measurements: 1. When the right side of the LCD shows "PULSE *", the requested resolution cannot be obtained. 2. To preset the counter to default settings, press "SET/ENTER", then "RESET".		

Table 1-1. Quick Reference Guide (Continued)

### Frequency Profile for INPUT 1

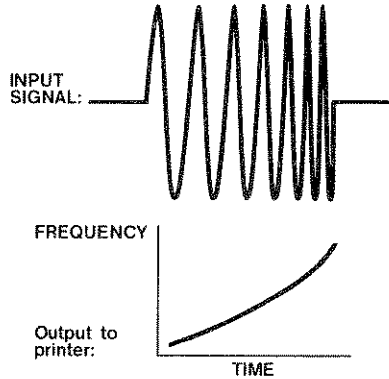

Use the steps listed here to profile a pulse or CW Sweep:

- SET Sample rate to "HOLD".
- SET 5361B HP-IB address to 31 (Talk Only). Press SET/ENTER, HP-IB ADDRESS, 3, 1, SET/ENTER
- SET printer to Listen Always and cycle power on the printer. If you're using a PaintJet, use EFUN 72 below.
- Connect printer to the 5361B.
- Ensure the 5361B is in Profile Function (Toggle Frequency/Profile key to Profile).
- Press Trigger. (External Gate required for CW Sweep.)
- Use Extended Functions (EFUN) 81-89 below to customize your measurement profile.

### Customizing Measurements on INPUT 1

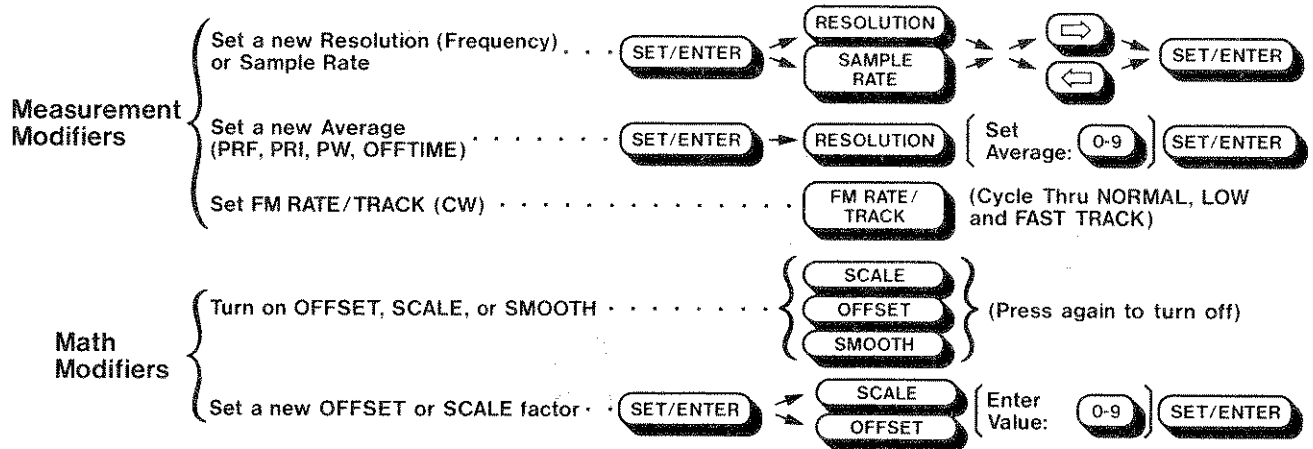

### Extended Function Entry (EFUN)

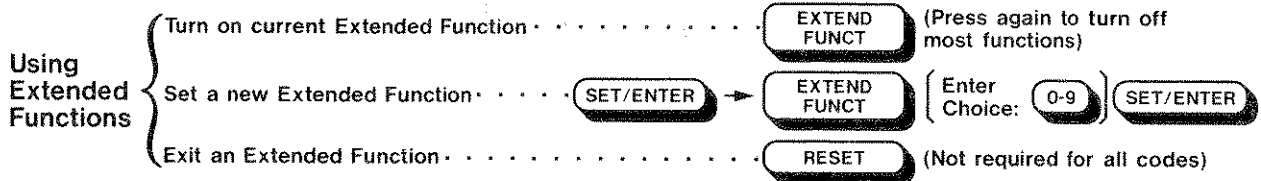

EFUN	--Frequency Profile EFUNs--	EFUN	--Measurement Modifier EFUNs--
81	Set START TIME for Frequency Profile	51	Down Converter Mode (Set LO between 300-350 MHz)
82	Set STOP TIME for Frequency Profile	72	Set Printer Option
83	Select FINE or COARSE Data for Frequency Profile	90	Set GATE WIDTH in Time
84	Select TABLE and/or PLOT for Output	92	Force PULSE or CW Measurement Mode
85	Set FILTER ON/OFF for Frequency Profile Plot	93	Enable LESS THAN 100 ns PULSE Mode (Manual Mode Only)
86	Enter ID PREFIX for Frequency Profile Plot	94	High Resolution: INPUT 1 PRF/INPUT 2 1MΩ
87	Set NUMBER OF DATA POINTS (Steps) for Frequency Profile	95	Set GATE WIDTH in IF Cycles
88	Set START IF CYCLE for Frequency Profile	96	Enter CHIRP Mode
89	Set NUMBER OF IF CYCLES PER STEP for Frequency Profile		

Refer to Section 2 of the HP 5361B Operating and Programming Manual for more information.

## HOW TO USE THE HP 5361B

Now that you've made some simple pulse/CW measurements and understand the basic operation of the HP 5361B, it's time to look at three typical ways to use this instrument. The examples that follow explain what to do and show how to connect the counter to other devices. The applications are pulse frequency profiling, VCO characterization, and making radar waveform frequency profile measurements. The last application illustrates the more traditional approach to the profiling task requiring extra test equipment such as a delaying pulse generator and external instrument control computer.

### Auto Pulse Profiling

If you need more precise information than the average frequency of a microwave pulse this application may be very useful. By using the Auto Pulse Profile feature, you can determine and measure changes of frequency within the pulse. This is necessary for measurements such as Chirp radar-burst frequency, pulsed Gunn diode oscillator thermal frequency shift, or pulsed magnetron leading edge frequency shift.

Follow the procedure below and refer to *Figure 1-4, Pulse Profiling Test Setup*, to complete this task.

1. Set the 5361B HP-IB address to 31 (Talk Only) by pressing the following keys: SET/ENTER, HP-IB ADDRESS, 3, 1, SET/ENTER.
2. Set the HP ThinkJet/QuietJet printer to Listen Always by ensuring that the Listen Always switch located next to the HP-IB connector is in the UP position. (You must cycle power to the printer to enable this new setting.)
3. Connect the counter's rear panel HP-IB connector to the printer's HP-IB connector with an HP-IB cable. (Do not connect any other HP-IB devices to this interface cable.)
4. Connect a repetitive pulse signal source to INPUT 1 of the 5361B.
5. Set the counter's sample rate to HOLD by pressing these keys: SET/ENTER, SAMPLE RATE, DEC (press until HOLD annunciator goes ON). Then press SET/ENTER again.



6. Ensure that the 5361B is in the PROFILE function by toggling the FREQUENCY/PROFILE key.
7. Press the TRIGGER key. (If you're profiling a CW sweep you'll need to supply an external gate signal to the front panel GATE/ARM IN connector.)
8. Use extended functions 81-89 to customize your measurement profile. (Refer to the fifth block of the Quick Reference Guide for more information.)

**NOTE** 

---

*Extended functions 81 and 82 require short-term signal stability of 70 kHz. If Errors occur while attempting use of these extended functions because of input signal instability, you can still use Efuncs 87, 88, and 89 to set up the measurement. The IF period will be 14 ns nominal.*

---

9. Observe the requested plot/table data output on the printer.
10. If you want to monitor the gating/measurement process within the pulse burst, simply connect the input of a suitable oscilloscope to the counter's front panel "SCOPE-VIEW" output.

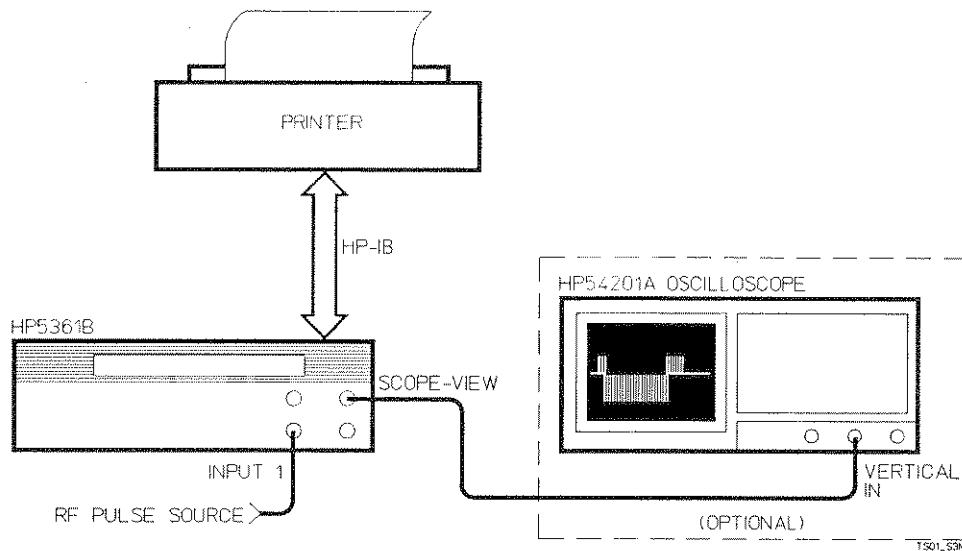

Figure 1-4. Automatic Pulse Profiling Test Setup

## VCO Characterization

Another problem you can solve with the HP 5361B is the characterization of microwave VCO tuning linearity. This task can be done automatically through the use of a controller (such as the HP 9000 Series 300 desktop computer) and a programmable DAC (digital-to-analog converter) or pulse generator to provide the voltage stimulus.

Use the following procedure and refer to *Figure 1-5, VCO Characterization Test Setup*, to complete this task. Additional information is available in application note #A.N. 377-2, "Automatic Characterization of Microwave Voltage Controlled Oscillators," publication number 5952-7988.

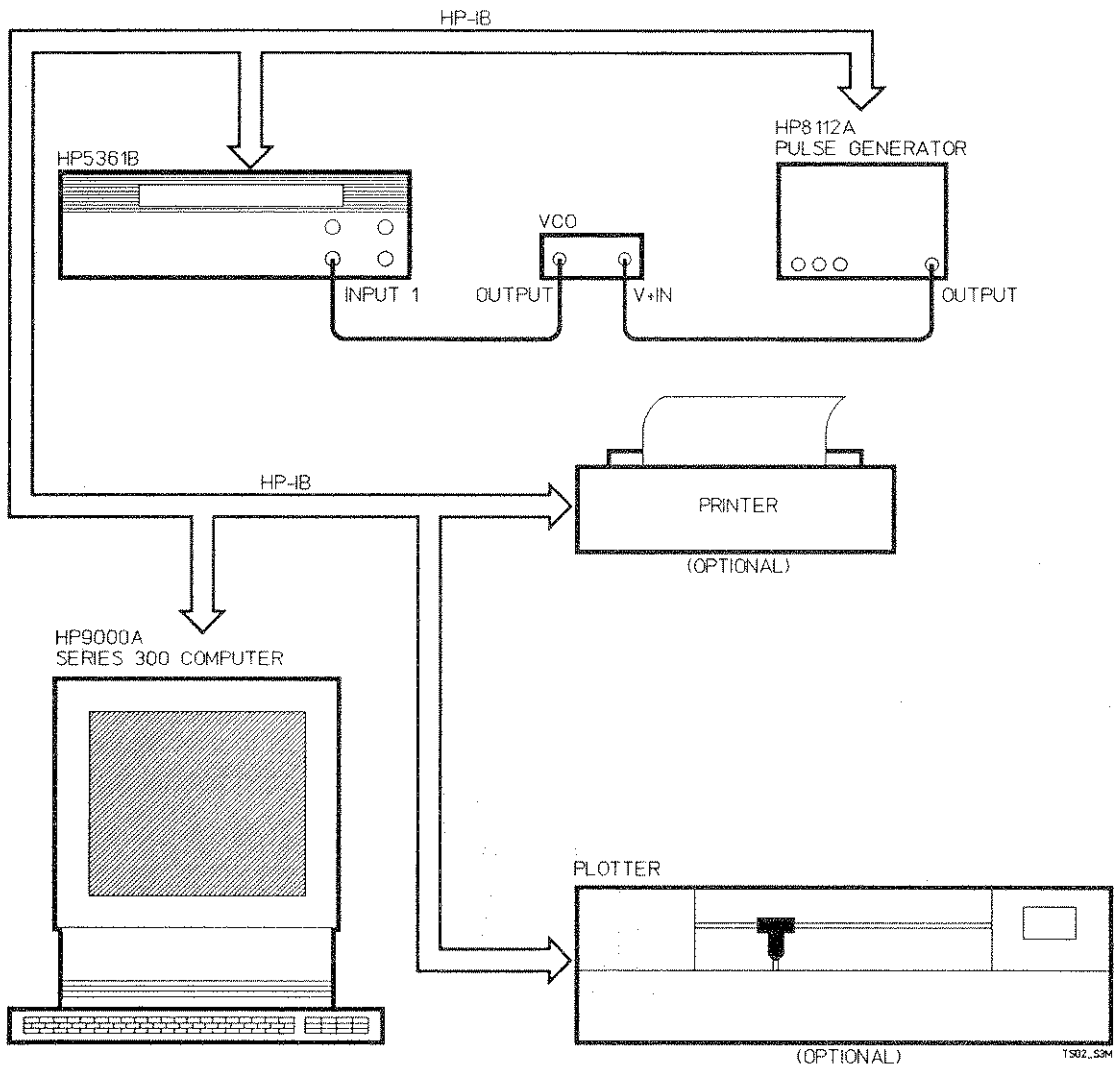

Figure 1-5. Traditional VCO Characterization Test Setup

1. Connect the controller, counter, and DAC or Pulse Generator together with two HP-IB cables.
2. Configure these units appropriately to the program you'll run on the controller. (Refer to Section 4 of this manual for details of HP-IB programming.)
3. Connect the output of the DAC/Pulse Generator to the VCO input.
4. Connect the output of the VCO to INPUT 1 of the HP 5361B if the frequency range is 500 MHz - MAX GHz or INPUT 2 if the frequency range is 10 Hz - 525 MHz.
5. If you're using INPUT 2 on the HP 5361B remember to select the correct input impedance (1 M $\Omega$  or 50 $\Omega$ ). (Stepped frequency characterization using a programmable DAC.)
6. Run the program you've made and check for proper operation.
7. You can have the controller print or plot the results via HP-IB to a printer or plotter.

### **Radar Waveform Frequency Profile Measurements**

A specific radar application of the HP 5361B is the measurement of radar waveform parameters. The frequency profile of a pulsed radar signal can be measured by the counter when used with a delaying pulse generator (such as the HP 5359A High Resolution Time Synthesizer) and oscilloscope (such as the HP 54201A Digitizing Oscilloscope). Two microwave attenuators are also used.

The external gate provided from the delaying pulse generator to the counter, can be as narrow as 20 nsec. (Refer to Appendix D for information about Gate width versus accuracy.) The delay time between the trigger to the delaying pulse generator and its output is incremented after each measurement. This causes the measurement window to "walk" through the RF pulse signal

Follow the procedure below and refer to *Figure 1-6, Radar Test Set-up*, to complete this task. Additional information is available in application note #A.N. 377-1, "Automatic Frequency Profiling of Chirped Radar Pulses," publication number 5952-7987.

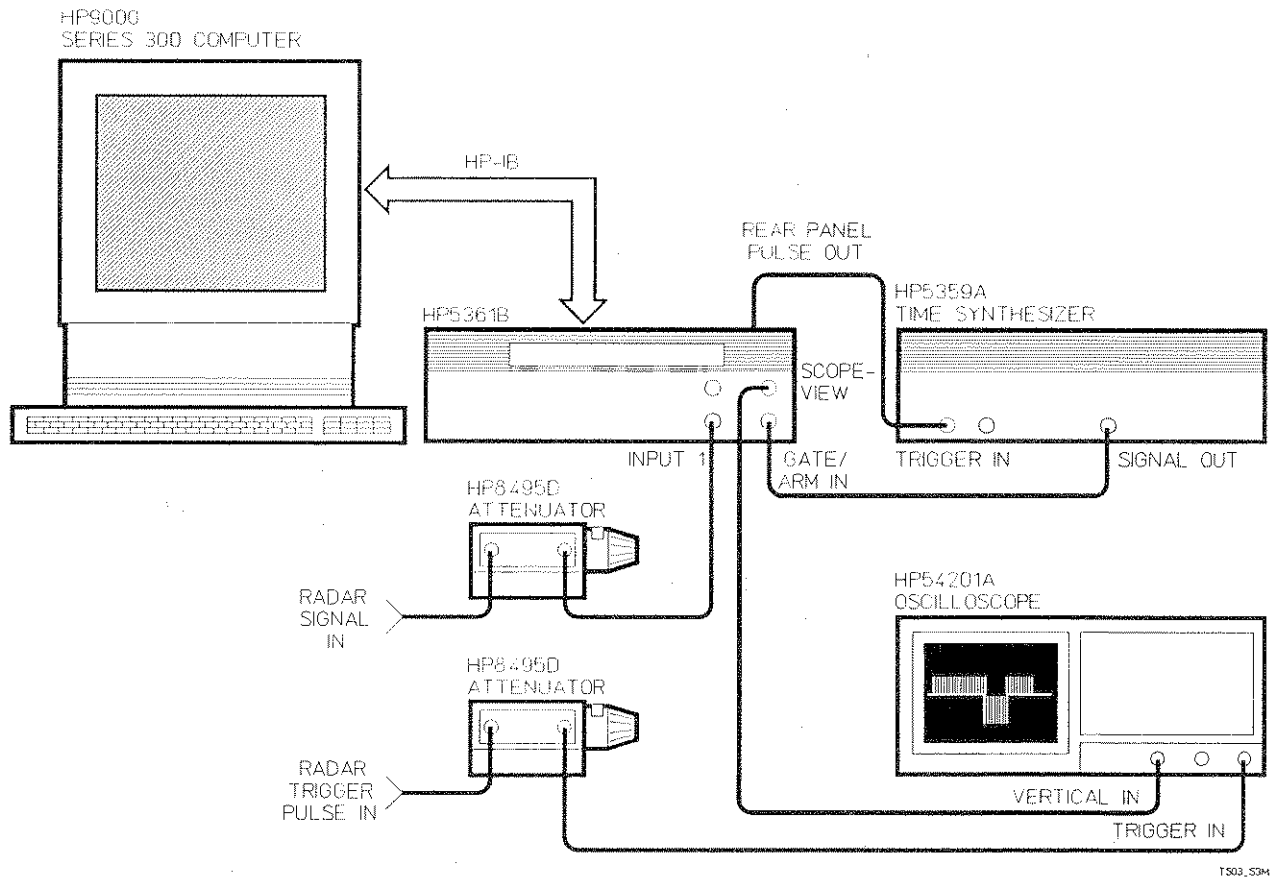

Figure 1-6. Traditional Radar Profiling Test Set-up

1. Connect the output of attenuator 1 to the INPUT 1 of the HP 5361B.
2. Connect the output of attenuator 2 to the trigger input of the oscilloscope.
3. Connect the HP 5361B rear panel Pulse Out signal to the trigger input of the delaying pulse generator.
4. Connect the output of the delaying pulse generator to the front panel GATE/ARM input of the HP 5361B.
5. Connect the SCOPE-VIEW output of the HP 5361B to the vertical input of the oscilloscope.
6. Set the HP 5361B to the External gate mode.
7. Adjust the delaying pulse generator to profile the input signal by sweeping the gate through the pulse burst.
8. Use the function keys on the HP 5361B front panel to select the desired pulse parameters.
9. You can optionally connect a controller to the counter for automatic test and data collection.

## OPTIONS

You can select several equipment options available for the HP 5361B as listed in *Table 1-2*. Specifications for the options are listed in Appendix A, *Table A-1*. (When option 700 (MATE) is present, the front panel and HP-IB Auto Profile features are not functional.)

If you've purchased an option with the initial order, it will be installed at the factory and ready for operation at delivery. You can obtain options (except Options 026, 040, and 700) for field installation by ordering the parts listed in Appendix B for a given option. Refer to Appendix B of this manual for installation information.

**ACCESSORIES**

The instrument is supplied with a detachable power cable. The power cable supplied will have one of six possible line (mains) connectors, depending on the country of destination. Refer to *Table B-1, AC Power Cables Available*, for the part number of the appropriate cable. *Table 1-3* lists accessories available for the HP 5361B.

*Table 1-2 Options Available*

Description	HP Part Number
Oven Oscillator Timebase (Option 001)	10811-60111 2360-0115
Limiter (Option 006)	05350-60111 5088-7049
High Stability Timebase (Option 010)	10811-60211 2360-0115
26.5 GHz Frequency Extension (Option 026)	None
40 GHz Frequency Extension (Option 040) (Not available with Option 700)	None
MATE (CIIL programming language) (Option 700) (Not available with Option 040)	None
Extra Operating and Programming Manual (Option 910)	05361-90018
Service Manual (Option 915)	05361-90003
Rack Mount Adapter Kits: With handles attached (Option 913) With handles removed (Option 908)	5062-4071 5062-3977
Slide Mount Kit Side Cover (1 required) Slide Assembly (1 pair)	5062-3835 1494-0060
Extended Hardware Support (Option W30)	None
Calibration Support (Option W32)	None

Option W30 (Extended Hardware Support) provides two additional years of return-to-HP hardware-service support. Option W30 is available only at time of purchase. Service contracts are available from Hewlett-Packard for instruments which did not include Option W30 at time of purchase. For more information, contact your nearest Hewlett-Packard Sales and Support office (offices are listed at the back of this manual).

**SERVICE  
EQUIPMENT  
AVAILABLE**

Extender boards and cables are available to aid in servicing printed-circuit board assemblies. The extender boards and cables allow assemblies to be extended from their plug-in connectors for monitoring with appropriate test equipment. Refer to *Table C-1, Recommended Test Equipment*, for part numbers for ordering service equipment.



## FURTHER USE OF THE HP 5361B

---

### SECTION GUIDE

This section provides you with more ways to get the most accuracy and versatility out of the HP 5361B. Measurement customization features of the counter are covered first followed by the details of measurement functions, modifiers, modes, gating, and data/math manipulation. Brief tutorials are also provided to "walk" you through the use of all front panel keys. Information about extended functions, HP-IB configuration, and remedies for problems is presented at the end of the section.

### Where to Find Important Topics

- Data Entry pg. 2-20
- Detailed Operating Procedure pg. 2-18
- Extended Functions pg. 2-58
- Maximum Input Signal Power pg. 2-16
- Measurement Capabilities pg. 2-22
- Signal Acquisition: Pulse vs CW pg. 2-2
- Signal Acquisition: Frequency pg. 2-2
- The Measurement Gate pg. 2-6/2-37
- Tutorial: CW Measurement pg. 2-23
- Tutorials: Pulse Measurement pg. 2-28
- Tutorials: Math Keys pg. 2-51
- Tutorials: Control/Data Keys pg. 2-41
- Remedies for Unexpected Situations pg. 2-81

### Section Summary

- How Your Measurements Get Customized pg. 2-2
- How Options Expand and Modify Measurement Capabilities pg. 2-10
- Using the HP 5361B pg. 2-11
- Measurement Modes pg. 2-23
- Making Pulse Measurements pg. 2-28
- Gating and Arming pg. 2-37
- Measurement/Math Modifiers pg. 2-41/2-51

- Extended Functions and HP-IB Configuration pg. 2-58
- What To Do If There Is a Problem pg. 2-81

## HOW YOUR MEASUREMENTS GET CUSTOMIZED

You can get a better idea of how your measurements get customized by reading the following paragraphs. They can provide you with descriptions of overall operation, functions, and characteristics of your HP 5361B. This information describes what gets done when you use these functions and corresponding keys.

### Overall Description

Your HP 5361B Pulse/CW microwave counter covers a measurement range of 10 Hz to MAX GHz. Signals in the frequency range of 10 Hz to 80 MHz are measured by the direct count method. Signals in the range of 80 MHz to 525 MHz are pre-scaled before counting. Signals in the range of 500 MHz to MAX GHz are down-converted to an intermediate frequency (IF) by HP's harmonic heterodyne down-conversion technique. The counted IF is added to, or subtracted from, a multiple of the local oscillator (LO) frequency to determine the input frequency. See *Figure 1-1*, HP 5361B Simplified High-level Block Diagram, in Section 1 for signal flow information.

The presence of a pulsed or CW signal is automatically determined, measured, and displayed without the need for prior acquisition tuning. All CW frequencies above 500 MHz are measured with user-selectable FM rate tolerance. Sample rate and resolution are adjustable via front panel controls for either pulse or CW signals. When required, you can easily "profile" the frequency change of either pulsed or CW sweep signals.

A microprocessor performs all measurement calculations, taking into account the selected function, resolution, measurement average, FM rate, and math functions. Frequency measurements are displayed in a fixed point format on the front panel liquid crystal display. Segments to the right of the numeric portion of the display are used to display additional, alphanumeric information.

To maximize accuracy and resolution, the instrument counting circuits use a reciprocal counting technique and analog interpolation. Because of this, the counter always makes a "period" measurement (averaged if necessary) of the measurement data, and then computes the results using

the reciprocal of the period measurement. Additional measurement accuracy is obtained through the use of analog interpolators to reduce the inherent one count uncertainty by compensating for time differences between the time base and input trigger events.

Internal gating of the incoming signal permits measurement of both time (P WIDTH, OFFTIME, and PRI) and frequency (PRF and Carrier Frequency) pulse parameters. External gating provides for pulse profiling and remote control of the gate when required. (PWIDTH and OFFTIME measurements can be made with the same results in either internal or external gate mode.)

## Additional Features

The HP 5361B is a fully HP-IB (IEEE Standard 488-1978) programmable instrument, capable of performing all operating functions via local or remote control. In addition to the basic pulse/CW measurement functions, the counter provides the following convenient features:

- Selectable Gate Modes (Arm, External, and Internal) provide a range of Gate options you can use when measuring either pulsed or CW signals. (Arm mode has no effect on CW measurements.)
- Front-panel Gate/Arm In connector provides a conveniently located input for measurement tasks that require triggers from auxiliary equipment.
- Front-panel SCOPE-VIEW output connector provides a unique combination of measured pulse signal superimposed with the measurement gate. Presentation of this signal on an oscilloscope shows the exact relationship of these two signals at a glance.
- Rear-panel pulse output supplies a trigger signal for such applications as pulse profiling in conjunction with a delaying pulse generator.
- Math Functions (offset, scale, and smooth) provide the capability of manipulating measurement data.
- Extended Functions permit checking on various internal measurement parameters that are created and used during the acquisition and measurement process. They also allow you to manually set up a measurement for specific needs.

- Diagnostics (a subset of the extended functions) can perform various internal checks of the counter's circuitry to aid in service and troubleshooting.

## Operating Ranges

There are two basic operating ranges: 10 Hz to 525 MHz (INPUT 2), and 500 MHz to MAX GHz (INPUT 1). Frequencies in the low range are measured directly or are prescaled, while frequencies in the high range are measured using HP's harmonic heterodyne down-conversion technique. Front panel function keys let you select INPUT 1 for signals in the 500 MHz to MAX GHz range, and INPUT 2 for signals in the 10 Hz to 525 MHz range.

Two function keys allow selection of either AUTO or MANUAL acquisition mode for INPUT 1 measurements. The low frequency input has two impedance modes and overlapping frequency ranges. You can select either 50Ω (10 MHz – 525 MHz) or 1MΩ (10 Hz – 80 MHz) input impedance for the INPUT 2 fused BNC connector.

## Resolution

The user selected resolution is the value represented by the least significant digit (LSD) in the display. In the HP 5361B, a maximum resolution of 1 Hz can be selected using the RESOLUTION key, together with the front panel SET/ENTER, INCREMENT and DECREMENT (arrow) keys. A greater resolution is available for INPUT 1 pulse repetition frequency and INPUT 2 measurements via the High Resolution extended function 94.

The displayed numerals of the measurement are grouped in four sections of three digits each for ease in determining GHz, MHz, kHz, and Hz placement. Asterisks or blanks are used as place holders to improve interpretation of the display, depending on the resolution. For example, a signal measured to 100 kHz resolution is displayed using asterisks, as shown below:

GHz	MHz	kHz	Hz
19	499	9**	

- while a signal measured to 1 MHz resolution will be displayed using blanks, as shown below:

	GHz		MHz		kHz		Hz	
	19		499					

When performing a low frequency, high impedance (INPUT 2, 1M $\Omega$ ) measurement or low pulse repetition frequency measurements, the HP-IB command HIRESOL can be used to set a resolution greater than 1 Hz, up to 0.001 Hz. The resolution obtained depends on the input frequency. High resolution is available through the use of HP-IB or extended function 94.

Refer to the Measurement Modifiers subsection (page 2-41) of this section for details of how to use the resolution function. The RESOLUTION key (page 3-7) is described further in Section 3, Controls and Indicators. Extended function 94 is described on page 2-77.

### **Auto Mode**

Select the Auto acquisition mode of operation by pressing the AUTO key. Input signals in the 500 MHz – MAX GHz range are acquired, measured, and displayed automatically. When power is initially turned on, the instrument goes into this mode. Refer to the Auto mode description (page 2-23) in the Measurement Modes subsection of this section for details on how to use the Automatic measurement mode. A more detailed description of the AUTO key (page 3-11) can be found in Section 3, Controls and Indicators.

### **Manual Mode**

Select the manual mode of operation by pressing the MANUAL key. To operate in this mode, input signals in the 1 GHz – MAX GHz range must be known to within 20 MHz (within 3 MHz in the 500 MHz – 1 GHz range), and this frequency (called the Manual Center Frequency) must be specified prior to the measurement. After the MANUAL key has been pressed, the most recent measurement becomes the Manual Center Frequency or you can select a Center Frequency by using the front panel data entry keys. Refer to the Manual mode description (page 2-24) in the Measurement Modes subsection of this section for details on how to use the Manual measurement mode. A more detailed description of the MANUAL key (page 3-12) can be found in Section 3, Controls and Indicators.

### **Internal Gating**

The counter generates its own internal gate to enable measurements of pulse carrier frequency. The process is normally automatic and transparent to the user. (Internal gating is also used by the Auto Profiling feature.) If your measurement needs require a specific gate width, you can override the normal setting by calling extended function 90 to specify the necessary gate time.

### **External Gating and Arming**

External Gating and Arming provide you with greater measurement control and versatility. External gating provides auxiliary control of the measurement gate and is necessary for such things as pulse profiling (INPUT 1 only) and other applications requiring remote timing and control of the measurement gate (INPUT 1 only). External arming is useful when you need to individually trigger each measurement in a train of consecutive pulse bursts (Pulse measurements only). The external gate/arm signal is provided to the HP 5361B via its front panel GATE/ARM IN connector. (Refer to Appendix D for information about advanced measurements with the GATE/ARM input.)

### **Gate Modes**

Three different gate modes are available via the front panel GATE MODE key: Arm, External, and Internal. Refer to the Gating and Arming subsection (page 2-37) of this section for details on how to use the GATE/ARM IN connector along with the front panel GATE MODE key. A more detailed description of the GATE MODE key (page 3-8) can be found in Section 3, Controls and Indicators.

### **Sample Rate**

The Sample Rate function sets the dead time between the end of one measurement and the start of the next measurement. The duration of the measurement gating time is determined by the resolution selected. The sample rate is adjustable in steps using the SAMPLE RATE key together with the front panel INCREMENT and DECREMENT (arrow) keys. When the sample rate is set to the maximum (FAST), the counter will make a measurement as frequently as possible. The other extreme (HOLD) causes the counter to hold the last displayed measurement indefinitely, until the TRIGGER key is pressed. Refer to the Measurement Modifiers (page 2-41) subsection of this section for details on how to use the SAMPLE RATE key. A more detailed description of the SAMPLE RATE key (page 3-9) can be found in Section 3, Controls and Indicators.

**FM Tolerance  
(CW only)**

The HP 5361B measures microwave signals modulated in frequency, such as a microwave radio carrier. The FM tolerance specifies the worst case FM deviations and rates which can be present without affecting the counter's ability to acquire the signal. The counter averages out the deviations to measure the actual carrier frequency it can tolerate, up to a maximum deviation of 20 MHz peak-to-peak, at an FM rate equal to or greater than 1 kHz, when the counter is set for normal FM rate tolerance.

**FM Rate and  
Frequency Tracking  
(CW only)**

The HP 5361B is capable of measuring FM signals at various FM rates by using the FM Rate/Track function. The FM RATE/TRACK key can be used to select Normal Rate, Low Rate, or Track mode. Most measurements can be made with the counter set to Normal Rate mode for signals with 1 kHz or greater rate of deviation.

The Track mode uses a faster acquisition time (with a corresponding loss of low FM rate tolerance) to increase the counter's ability to track signals with FM rates of 300 kHz or greater (for FM deviations up to the maximum specified in *Table A-1*). Conversely, the Low Rate mode uses a longer gate time for harmonic number determination to allow measurements at FM rates as low as 45 Hz for the specified FM deviation.

Refer to the Measurement Modifiers subsection (page 2-49) of this section for details on how to use the FM rate/track function. A more detailed description of the FM RATE/TRACK (page 3-10) key can be found in Section 3, Controls and Indicators. Refer to *Table A-1* for FM Rate/Track and FM deviation specifications.

**AM Tolerance  
(CW only)**

The HP 5361B is capable of measuring a signal within typical AM modulation index boundaries as described in the Specifications, Appendix A of this manual. The minimum signal level must be greater than the sensitivity specification, and the maximum signal level less than the maximum operating level specification.

**Offset Values**

The Offset function lets you add or subtract a constant value to/from a frequency or pulse parameter measurement. For example, when measuring a radio IF and knowing the LO, the counter can be set to display the RF input by entering the LO frequency as a positive offset. When tuning an oscillator to a specific frequency, it may be easier to enter the desired

frequency as a negative offset and then tune the oscillator until the counter display reads zero.

Offset values are entered using the OFFSET key together with front panel number keys, or the Last V (Last Value) key. Refer to the Math Modifiers subsection (page 2-51) of this section for details on how to use the offset function. A more detailed description of the OFFSET key (page 3-5) can be found in Section 3, Controls and Indicators.

**Scale** The Scale function keys let you multiply the measured frequency/pulse parameter by a scaling factor selected on the keyboard. The scaling factor is set using the SCALE key together with front panel number keys. When entered, the measured frequency is multiplied by this factor, and the resulting product is displayed by the counter. Scale factors can range from 0.0001 to 9999.

When the entered scale factor is a whole or mixed number, multiplication results. If the entered scale factor is a decimal fraction, multiplication still occurs, but the results may be viewed as a quotient. You may effectively perform a division problem by taking the reciprocal of a divisor, using it as your scale factor.

The Scale function can also be used together with the Offset function ( $(V_{in} \times \text{Scale}) + \text{Offset}$ ). Refer to the Math Modifiers subsection (page 2-55) of this section for details on how to use scale factors. A more detailed description of the SCALE key (page 3-6) can be found in Section 3, Controls and Indicators.

**Smooth** The Smooth function provides a means of "smoothing" the display for easier reading, and is turned on or off by pressing the SMOOTH key. When the Smooth function is on, the counter displays only digits that are relatively stable, and keeps a running average of the measurements to remove small deviations and increase displayed digits. The smooth function is available only for CW and pulse carrier frequency measurements. Refer to the Math Modifiers subsection (page 2-57) of this section for details on how to use the smooth function. A more detailed description of the SMOOTH key (page 3-6) can be found in Section 3, Controls and Indicators.



## **Self Check/Cal**

The Self Check function lets you make a quick operational verification of the counter and performs a gate bias calibration. Just press the SELF CHECK/CAL key to call this functional test and calibration. Self Check calls up program subroutines to test the measurement circuitry and calibrate the gating circuits. Refer to the Extended Functions (page 2-58) and What To Do If There Is a Problem (page 2-81) subsections of this section for details on how to use the Self Check/Cal function. A more detailed description of the SELF CHECK/CAL key (page 3-9) can be found in Section 3, Controls and Indicators.

## **Extended Functions**

The HP 5361B has a variety of extended function routines that provide additional measurement information, provide custom measurement setups, and perform various tests on the instrument for troubleshooting. The extended function mode is turned on by pressing the EXTEND FUNCT key. A particular extended function (EFUN) may be selected using the EXTEND FUNCT key together with front panel number or arrow keys. Refer to the extended function descriptions (page 2-58) and What To Do If There Is a Problem (page 2-81) subsection of this section for details on how to use extended functions. A more detailed description of the EXTEND FUNCT key (page 3-8) can be found in Section 3, Controls and Indicators.

## **Remote Operation**

The HP-IB connector on the rear panel of the counter is compatible with the HP 10833A/B/C/D HP-IB cables, allowing the HP 5361B to be operated remotely within the Hewlett-Packard Interface Bus system. In remote operation, all counter functions normally available by front panel control (except POWER/STBY and setting the HP-IB Address) are also available via HP-IB.

The HP-IB system allows interconnection of up to 15 HP-IB compatible instruments (including the controller). The HP-IB cables have identical piggyback connectors on both ends so that several cables can be joined to a single source without special adapters or switch boxes. System components and devices may be connected in virtually any desired configuration.

Refer to the HP-IB Configuration discussion (page 2-80) of this section for details of how to display and change the HP-IB address. Interconnection data concerning the HP 5361B rear panel HP-IB connector and restrictions on the Hewlett-Packard Interface Bus connection are located at the

beginning of section 4 of this manual. Section 4 also contains remote programming information for the HP-IB.

**HOW OPTIONS  
EXPAND AND  
MODIFY  
MEASUREMENT  
CAPABILITIES**

The operating characteristics of the HP 5361B are affected by the addition of any of the options described in the following paragraphs. Refer to *Table A-1* for all option specifications.

**Option 001  
Oven Oscillator  
Time Base**

With the addition of the Option 001 Oven Oscillator, the effects of temperature variations are reduced, and short-term stability and aging rate are improved. Improved aging allows extended calibration periods. The oven temperature is maintained when the HP 5361B POWER switch is in either the ON or STBY position (provided that ac power is connected to the instrument). When the OVEN annunciator on the front panel display is lit, the oscillator is warming. When the oven is at the proper temperature, the OVEN annunciator goes out.

**Option 006  
Limiter**

Option 006 provides additional input protection for the HP 5361B by the insertion of a limiter between the front panel high frequency connector (INPUT 1) and the input circuitry. Option 006 increases the damage level specification of the instrument, as listed in *Table A-1* under Option 006 Increased Damage Level. An HP 5361B will have its damage level increased by about 10 to 14 dB for CW inputs, depending on frequency, and may increase by as much as 25 dB for pulsed applications.

**Option 010  
High Stability  
Time Base**

The addition of the Option 010 High Stability Oven Oscillator improves the aging rate over that of the Option 001 Oscillator, allowing further extended calibration periods of up to five years. The oven temperature is maintained in exactly the same way as for the Option 001 Oscillator, and the OVEN annunciator on the front panel display performs identically, lighting when the oven is warming, and going out when the oven is at the proper temperature.

**Option 026  
26.5 GHz Frequency  
Extension**

Option 026 extends the frequency range of the HP 5361B to 26.5 GHz. Refer to Appendix A for option 026 specification information.

**Option 040  
40 GHz Frequency  
Extension**

Option 040 extends the frequency range of the HP 5361B to 40 GHz. Refer to Appendix A for option 040 specification information. (Not available with Option 700.)

**Option 700  
Internal  
CIIL Interface  
(MATE)**

The addition of Option 700 (Factory installable only) permits remote operation via the CIIL programming language. This programming language is required by the United States Air Force for its Modular Automated Test Equipment (MATE) programs and facilities. (Not available with Option 040.)

**USING THE  
HP 5361B**

The following paragraphs provide detailed operating information and instructional procedures for each major functional mode of the HP 5361B. Within each specific measurement mode, a considerable amount of flexibility is present for both the type of input signal and measurement technique. These operating guidelines should assist in making the most useful and accurate measurements possible.

The remainder of this section is organized as follows:

1. Measurement Modes
2. Making Pulse Measurements
3. Gating and Arming
4. Using Measurement Modifiers
5. Using Math Modifiers
6. Extended Functions and HP-IB Configuration
7. What To Do If There Is A Problem

The following paragraphs provide you with information about inspection before use, power-up/warm-up, operator's checks and maintenance, maximum input signal power, and both preliminary and detailed operating procedures. Before using your HP 5361B for the first time its a good idea to perform the following warm-up procedure and all operator checks.

**Power-up/Warm-up**

The HP 5361B requires a power source of 100-, 115/120-volts ac rms, +5%, -10%, 47.5 - 440 Hz single phase, or 220-, 230/240-volts ac rms, +5%, -10%, 47.5 - 66 Hz single-phase; 100VA maximum. The selection of the line voltage and input power fuse is described in Appendix B, Installation, under

“Line Voltage and Fuse Selection”. Safety considerations are described at the beginning of this manual.

### CAUTION

---

*To prevent damage to the instrument, make sure that the voltage selector card is set to the voltage of the power source, and that the correct fuse is installed, before connecting the instrument to ac power lines. Refer to Appendix B.*

---

The HP 5361B has a two position (STBY/ON) power switch. For the Option 001 Oven Oscillator Timebase or the Option 010 High Stability Timebase, it is important that the instrument remain connected to the power source in the Standby (STBY) mode when not in use. This supplies power to the crystal oscillator oven, maintaining a constant oven temperature, thus eliminating the need for a warm-up period. Power also remains supplied to portions of the microprocessor RAM saving such things as front panel setup parameters. When the Standby mode is not active, and power has been disconnected from the instrument, you should allow 30 minutes from the application of external power in the ON mode for the instrument (crystal oven) to warm-up.

### WARNING

---

**BEFORE APPLYING AC POWER, THE INSTRUMENT AND ALL PROTECTIVE EARTH TERMINALS, EXTENSION CORDS, AUTO-TRANSFORMERS, AND DEVICES CONNECTED TO THE INSTRUMENT SHOULD BE CONNECTED TO A PROTECTIVE EARTH GROUNDED SOCKET. ANY INTERRUPTION OF THE PROTECTIVE EARTH GROUNDING WILL CAUSE A POTENTIAL SHOCK HAZARD THAT COULD RESULT IN PERSONAL INJURY.**

---

## Operator's Checks

The following procedures verify the basic operation of the HP 5361B. These tests are not intended to confirm the overall accuracy or performance specifications of the instrument. They should, however, provide you with a quick method of determining that the counter is operating properly. Two operator tests are described below: a Power-Up Self Check/Cal, and a Keyboard Check. If you haven't done so

already, you should familiarize yourself with the checks by performing both.

**CAUTION**

**Before you switch on the instrument, ensure the following:**

- 1. The voltage selector card is set to match the available line voltage. (Refer to Appendix B, Installation, Line Voltage and Fuse Selection).**
- 2. The correct fuse is installed. (Refer to Appendix B as above.)**
- 3. All safety precautions and WARNINGS have been observed.**

**POWER-UP SELF CHECK**

To perform the Power-Up Self Check/Cal after the instrument has been turned on, cycle the POWER switch to STBY (Standby), then back to ON. During the Power-Up Self Check/Cal, all front panel LCD display segments and annunciators light momentarily, followed by the message "FUNC 54 CALIBRATING", then momentary display of the current HP-IB address. When all calibration and tests have been successfully completed, the counter measurement status is restored to conditions set before the POWER switch was cycled. (Note that the Power-Up Self Check/Cal is a more extensive test of the instrument than that carried out when the front panel SELF CHECK/CAL key is pressed. Refer to the extended function descriptions for details.

If ac power was applied to the instrument prior to power-up, the counter will initialize itself to the following conditions when the POWER switch is set to ON:

- a. Measurement modes:
  - Auto (signal acquisition) – ON
  - Manual (signal acquisition) – OFF
  - Manual CF – 1 GHz
  - Low Frequency 50Ω – OFF
  - Low Frequency 1MΩ – OFF
  - Low PRF Mode (Pulse Only) – OFF
  - <100 ns Pulse Mode (EFUN 93) – OFF
  - Chirp Mode (EFUN 96) – OFF

- b. Measurement functions:
  - Carrier Frequency — ON
  - Frequency Profile — OFF
  - Pulse Width — OFF
  - Pulse Offtime — OFF
  - Pulse Repetition Frequency — OFF
  - Pulse Repetition Interval — OFF
- c. Gate Mode — INTERNAL
- d. Measurement modifiers:
  - Sample Rate — FAST
  - Resolution — 1 MHz INPUT 1/  
1 Hz INPUT 2
  - Pulse Averaging — 1 (OFF)
  - FM Rate/Track — NORMAL  
(CW only)
  - High Resolution — OFF
- e. Math functions:
  - Offset — OFF, 0 Hz
  - Scale — OFF, 1.000
  - Smooth — OFF
- f. HP-IB address — Rear panel  
switch setting
- g. Extended Functions — OFF, 1

After the counter has initialized, the AUTO and FM NORM (CW only) annunciators are on, and the counter begins counting, if an input has been applied to INPUT 1. If no input has been applied to INPUT 1, the display will show all zeros, as follows:

GHZ	MHZ	kHz	Hz
00	000	000	000

**KEYBOARD CHECK**

Press the following key sequence: SET/ENTER, EXTENDED FUNCTIONS, 7,0, SET/ENTER. The instrument is now in the Keyboard Test extended function (EFUN 70). The following message is displayed:

KEY TEST A7 F 70

In the Keyboard Test, pressing front panel keys causes the display to change in response to the particular key being pressed. The new display remains until another key is pressed. For example, pressing the TRIGGER key will cause the display to change to the following:

KEY TRIGGER A7 F 70

When performing the Keyboard Test, the keys may be pressed in any order, except the RESET/LOCAL key. You should press each of the keys and make sure that the associated message for each key is displayed, as listed below.

FREQ	OFFSET	RESOL	SELF CK	50 OHM
PW/OFF	SCALE	GATE MD	HP-IB	1 MOHM
PRF/PRI	SMOOTH	FUNC	FM RATE	AUTO
RESET	SET	SAMP RT	TRIGGER	MANUAL

Pressing the RESET/LOCAL key will cause the instrument to display "RESET" momentarily, and then exit from the test.

## Operator's Maintenance

The only maintenance the operator should normally perform is replacement (when necessary) of two fuses: the primary power fuse (F1) located within the AC Power Input Module on the rear panel, and the Low Frequency Input fuse (J2F1) located in the front panel INPUT 2 connector. Refer to Appendix B, Installation, *Figures B-1*, Changing the Line Fuse and Selecting the Line Voltage, and *B-3*, Details of INPUT 2 Connector and Low Frequency Input Fuse.

### CAUTION

---

***Make sure that only fuses with the required rate current and voltage ratings and of the time delay (slow-blow) type are used for replacement of the primary power fuse. Do not use repaired fuses or short-circuited fuse holders.***

---

The low frequency input fuse J2F1 is a 1/8A fuse (HP Part Number 2110-0301) located within the INPUT 2 BNC connector J2 (HP Part Number 1250-1899), as shown in *Figure B-3*. To replace the fuse, disconnect the power cord,

unscrew the BNC barrel and, with needle-nose pliers, remove and replace the fuse. Reinstall the BNC barrel, and tighten using a 7/16 inch wrench. Tighten to 20 inch-pounds.

### Maximum Input Signal Power

The following paragraphs describe in detail the limitations and cautions associated with front panel inputs 1 and 2.

#### HIGH FREQUENCY INPUT (INPUT 1)

#### CAUTION

---

*Do not exceed +25 dBm (peak) input power (or +/-4V dc) at the INPUT 1 connector (500 MHz - MAX GHz). Damage to the internal sampler may occur.*

*The HP 5361B functions within its specifications for signal inputs up to +7 dBm in the 500 MHz - MAX GHz range. Under no circumstances should the input level to the HP 5361B ever exceed +25 dBm, peak. If the input power exceeds +25 dBm, permanent damage to the internal sampler may occur.*

*Measurements from +7 to +25 dBm are not recommended, as false readings may occur. When signal levels exceed +7 dBm, external attenuators should be used to reduce the signal power.*

#### NOTE

---

*A level indication may appear on the front panel display under high input signal conditions or during the IF AGC settling time. A power meter or similar device may be used to verify that the input signal level does not exceed INPUT 1 specifications. DO NOT DEPEND ON THE LEVEL INDICATION FOR THIS PURPOSE.*

---

#### LOW FREQUENCY INPUT (INPUT 2)

The 10 Hz – 525 MHz Low Frequency input BNC connector contains a fuse to provide protection from input levels which exceed the specified damage level for INPUT 2: 5.5V rms (+28 dBm). Refer to the Operator's Maintenance previously discussed for instructions on how to change the front panel fuse.



---

## CAUTION

---

**The INPUT 2 damage level described above is only a simplified form of the complete specification. Refer to Table A-1 for the complete Damage Level specification for INPUT 2.**

---

### INPUT CABLE CONSIDERATIONS

Consideration should be given to input cable losses at higher frequencies. For example, a 6-foot length of RG-214/U coaxial cable has about 15 dB loss at 18 GHz. At frequencies beyond 20 GHz, waveguides may be used to help minimize losses depending on such factors as the total number of devices in a test setup and the overall attenuation. Such losses must be taken into consideration along with the sensitivity specifications given in *Table A-1*.

### Preliminary Procedures

Preliminary procedures provide you with the initial steps to perform prior to actual measurement of pulse/CW signals input to the front panel.

1. On the rear panel:
  - a. Ensure that the ac power module has the proper fuse installed: 1.0A time delay (slow-blow) for 100/120-volt operation, 0.5A time-delay (slow-blow) for 220/240-volt operation. Be certain the position of the printed circuit line voltage selector card is set for the correct voltage. (Refer to Appendix B, Installation, and to associated warnings and cautions in Appendix B of this manual for detailed instructions).
  - b. For remote operation, refer to Section 4 for an explanation of HP-IB programming, and *Figure 4-1* for information on setting the HP-IB address switch on the rear panel.
  - c. Insert the three-conductor power cable (W1) into the ac power module of the HP 5361B, and insert the mains plug of the power cable into a power outlet equipped with a protective earth ground.
2. On the front panel:
  - a. When the POWER switch is set to STBY, the red LED next to the POWER switch should light with ac power is applied.

- b. Set the POWER switch to ON; the red LED should go out.

**NOTE**

*When using INPUT 1, do not exceed +25 dBm (peak) input power (or +/- 4V dc) at the input connector (500 MHz-MAX GHz). Damage to the internal sampler may occur.*

*A level indication may appear on the front panel display under high input signal conditions or during the IF AGC settling time. A power meter or similar device may be used to verify that the input signal level does not exceed INPUT 1 specifications. DO NOT DEPEND ON THE LEVEL INDICATION FOR THIS PURPOSE.*

**CAUTION**

*The INPUT 2 BNC connector (10 Hz-525 MHz) is fuse-protected from input levels which exceed the specified damage level of 5.5V rms (+28 dBm).*

3. Connect input signal to the input connector that is appropriate for the frequency being measured: INPUT 1 N-type or APC 3.5 connector for 500 MHz – MAX GHz and INPUT 2 BNC connector for 10 Hz – 525 MHz.
4. For input signals connected to the INPUT 2 (BNC) connector, press the 50Ω or the 1MΩ front panel key as required. Pressing one of the INPUT 2 keys disables the INPUT 1 circuitry.

**Detailed Operating Procedures**

The following paragraphs explain how you use the front panel keys once the unit is on and an input signal is connected. In addition, parameter entry, keyboard memory, data entry problems, and power-up default values are covered. The term "Power-up" refers to connecting ac power to the instrument and then turning it on, as distinct from "Standby", which assumes that ac power is continuously connected. A table that summarizes the HP 5361B measurement capabilities is provided at the end of this subsection.

If the POWER switch is turned from ON to STBY and then back to ON, the counter retains the setup conditions active before the POWER switch was toggled. Exceptions to this include the HP-IB interface, which is cleared, and extended

functions, which default to power-up conditions: EFUN 1, OFF. Refer to *Table 2-1* for a list of all Power-Up default and Standby conditions. The HP 5361B can be "Preset" to the power-up default values without cycling power by using the following keys: first press Set/Enter, then Reset/Local. All parameters will return to default except the HP-IB address.

Most of the remaining procedures include an example of a typical display for the operation being described. Some multi-key procedures show examples of displays that occur at certain points in the indicated key sequence. The actual contents of each function display depend on the function in progress, and on the frequency being measured.

The HP 5361B has six basic measurement modes:

- Pulse Measurement Mode
- CW Measurement Mode
- Automatic Signal Acquisition (INPUT 1, 500 MHz – MAX GHz)
- Manual Signal Acquisition (INPUT 1, 500 MHz – MAX GHz)
- Low Frequency 50 $\Omega$  (INPUT 2, 10 MHz – 525 MHz)
- Low Frequency 1M $\Omega$  (INPUT 2, 10 Hz – 80 MHz)

When first powered-up, the instrument comes on in the Automatic Signal Acquisition mode and can automatically determine whether a pulse or CW signal is present at INPUT 1. If the counter is turned on from Standby, the measurement mode is whatever was previously set. To change to any other measurement mode, press the corresponding key. Pressing the key for the currently active mode has no effect. *Table 2-1* lists parameter power-up default values and ranges for various functions of the HP 5361B.

Using certain functions, such as Offset, Scale, or Average may involve the entry of numeric data using the Control/Data keys. Other functions allow selection of their parameter values from a specific range using the INC (increment) and DEC (decrement) keys, such as Sample Rate and Resolution. Still other functions simply toggle, such as OFFTIME, PRI, or the Smooth function. If the user should attempt to enter the incorrect type of data as a function parameter value, the

counter displays one of the following messages to indicate the type of data entry required:

*PLEASE USE ARROW KEYS*

— or —

*PLEASE USE DIGIT KEYS*

If data entry is attempted for a toggle function, the counter displays:

*TOGGLE FUNCTION ONLY*

### **Entering Parameter Values**

Parameter value entry always begins by pressing the SET/ENTER key once, and stops by pressing the SET/ENTER key a second time. While entering a parameter value, you may abort the entry sequence at any time by pressing the RESET/LOCAL key. The counter then returns to the state it was in before the SET/ENTER key was pressed.

After you've pressed the SET/ENTER key once, the display shows "SET", and the counter waits for a function key to be pressed. After the SET/ENTER and the function key have been pressed, the keyboard is in the parameter entry mode, and the data entry assignment of each Control/Data key is accessible. (Refer to *Table 3-2*). The response to each key depends on the specific function involved. The INC, (increment) and DEC (decrement) keys repeat if held down. The function names appear in the right hand portion of the display during entry of the parameter value.

As an added convenience, you may use the GHz/ms, MHz/ $\mu$ s, or kHz/ns key functions when entering manual frequency or time values. Begin as above by pressing SET/ENTER, enter your data, then press the appropriate frequency/time unit key without pressing SET/ENTER a second time. Use of these keys lets you avoid entry of multiple zeros and results in fewer keystrokes needed to make a given data entry.

Table 2-1. Parameter Ranges and Default Values

Parameter	Range of Values	Power-up Values	Standby
Measurement Mode	Auto, Manual, 50 $\Omega$ , 1M $\Omega$	Auto	saved*
Manual Center Frequency	500 MHz to MAX GHz On, Off	1 GHz, Off	saved
Offset Frequency	$\pm$ 0 Hz to 999.9 GHz On, Off	0 Hz, Off	saved
Scale Factor	$\pm$ 0.0001 to 9999 On, Off	1.000, Off	saved
Smooth	On, Off	Off	saved
Sample Rate	Fast, 0.5s, 1.5s, 3s, 5s, 10s, Hold	Fast	saved
Averaging	1 to 9,999 On, Off	1, Off	saved
Resolution	1 Hz, 10 Hz, 100 Hz, 1 kHz, 10 kHz, 1 MHz	1 Hz	saved**
Gate Mode	Arm, External, Internal	Internal	saved
HP-IB Address	0 to 31	Rear panel	saved switch
Extended Func.	1 to 99 On, Off	1, Off	1, Off
FM Rate/Track	Normal, Low, Track	Normal	saved
High Resolution	On, Off	Off	saved
*Auto PROFILE, Low PRF, <100 ns Pulse, and Chirp Mode are not saved and are OFF at power-on.			
**The resolution for the selected input is saved at power-off. The resolution for the alternate input is lost. The appropriate default is used at power-on: 1 MHz for INPUT 1, 1 Hz for INPUT 2.			

## Keyboard Memory

Whenever the instrument is set to Standby, the microprocessor automatically stores the front panel settings, as long as its connected to an ac power source. When the instrument is turned back on, it is set to the last front panel settings. This avoids having to re-enter math constants, functions or data, whenever the instrument is switched to Standby. If ac power is applied to the counter just prior to turn-on, all function parameters are initialized to their power-up default values. Parameter value ranges and default values are shown in *Table 2-1*. The HP 5361B can be "Preset" to the power-up default values without cycling power by using the following keys: first press Set/Enter, then Reset/Local. All parameters return to default except the HP-IB address.

## Data Entry Considerations

Certain parameters, such as offset values or scale factors, are entered as numeric data, using the Function/Data keys. Other parameter values can be selected from a specific range using the INC (increment) and DEC (decrement) keys, as with the Sample Rate and Resolution parameters. Still other parameters are simply toggle functions, as for example the Smooth or FM Rate Tolerance parameters. If you attempt to enter the incorrect type of data as a parameter value, the counter displays either "PLEASE USE ARROW KEYS" or "PLEASE

USE DIGIT KEYS" to indicate the type of data entry required. If data entry is attempted for a toggle function, the counter displays "TOGGLE FUNCTION ONLY".

Table 2-2, Measurement Capability Cross Reference Chart, summarizes all of the Pulse/CW measurement functions, modes, modifiers, and gating capabilities of the HP 5361B Pulse/CW Microwave Counter.

Table 2-2. Measurement Capability Cross-Reference Chart

Pulsed Measurement	Acquisition Mode		Measurement Modifier		FM Rate			MATH Modifier			Gate/Arm		
	Auto	Manual	Resol/Avg	Samp Rate	L	N	T	Offset	Scale	Smooth	Int	Ext	Arm
P WIDTH	YES	YES	YES	YES	N/A	N/A	N/A	YES	YES	NO	YES	NO	YES
OFFTIME	YES	YES	YES	YES	N/A	N/A	N/A	YES	YES	NO	YES	NO	NO
PRF	YES	YES	YES	YES	N/A	N/A	N/A	YES	YES	NO	YES	NO	YES
PRI	YES	YES	YES	YES	N/A	N/A	N/A	YES	YES	NO	YES	NO	YES
FREQ	YES	YES	YES	YES	N/A	N/A	N/A	YES	YES	YES	YES	YES	YES
PROFILE	YES	YES	YES	YES	N/A	N/A	NA	YES	YES	NO	YES	YES	YES
CW Measurement	Acquisition Mode		Measurement Modifier		FM Rate			MATH Modifier			Gate/Arm		
	Auto	Manual	Resol	Samp Rate/Avg	L	N	T	Offset	Scale	Smooth	Int	Ext	Arm
FREQ	YES	YES	YES	YES	YES	YES	YES	YES	YES	YES	YES	YES	N/A

## MEASUREMENT MODES

Each tutorial operating procedure shows you the key (or key sequence, as necessary) to be pressed to perform the desired function, and resulting display. A brief description of the effect of each function is given, and the allowable range for any parameter values are described, if applicable. The Power-up default conditions for each function are also given, with the term "Power-up" referring to connecting ac power to the instrument and then turning it on, as distinct from "Standby", which assumes that ac power is continuously connected.

### Power-up Default Values

The counter powers-up to the following six basic measurement mode defaults (See *Table 2-1* for details):

Pulse/CW	
Signal Determination	– AUTO
Auto (Signal Acquisition)	– ON
Manual (Signal Acquisition)	– OFF
Manual Center Frequency (CF)	– 1 GHz
Low Frequency, 50Ω	– OFF
Low Frequency, 1MΩ	– OFF

### Automatic Measurement Mode (AUTO)

This procedure describes how to set the measurement mode for INPUT 1 to Automatic. For instance, if you want to make an automatic measurement of a 1.000 000 000 GHz signal, perform the following action.

Press: **AUTO**

	GHz	MHz	kHz	Hz.	
Observe:	1	000			

(AUTO annunciator goes on)

**Effect:** Turns ON Automatic Measurement Mode (INPUT 1, 500 MHz – MAX GHz). To exit this mode, press one of the other measurement mode keys; pressing the AUTO key a second time has no effect. The instrument powers-up in this mode.

**Parameter Value Range:** Toggle function.

**Note:** This key applies to signal acquisition only and causes the counter to automatically tune to the frequency of the signal present at INPUT 1. The Auto function key does not control the instrument's ability to automatically distinguish between Pulse or CW signals.

**Manual Measurement Mode (MANUAL)**

This procedure describes how to set the measurement mode for INPUT 1 to Manual. For instance, if you want to make a manual measurement of the last Auto measurement of 1.200 000 000 GHz, perform the following action.

Press: **MANUAL**

		GHz		MHz		kHz		Hz		
Observe:		1		200						MANUAL

(display shows new CF momentarily, then returns to measurement display; MAN annunciator goes on)

**Effect:** Turns ON Manual Measurement Mode (INPUT 1, 500 MHz - MAX GHz), and sets Manual Center Frequency (CF) to value of last Auto measurement. To exit this mode, press one of the other measurement mode keys; pressing the MANUAL key a second time has no effect.

**Parameter Value Range:** Last Auto measurement value must be within 500 MHz - MAX GHz. If last Auto measurement attempt was unsuccessful, the Manual CF remains at the previous setting.

**Note:** This key applies to signal acquisition only and causes the counter to seek a signal at the frequency of the last automatic measurement or subsequent manually entered CF. The Manual function key does not control the instrument's ability to automatically distinguish between Pulse or CW signals.

**Set Manual Center Frequency**

This procedure describes how to set a desired Center Frequency (CF) while in the manual measurement mode. In the example below you are shown how to set a CF of 12.3 GHz

Press: **SET/ENTER, MANUAL, 1, 2, 3, 0, 0, SET/ENTER**

— or —

**SET/ENTER, MANUAL, 1, 2, ., 3, GHz**



	GHz	MHz	kHz	Hz	
Observe:	12	300			MANUAL

— then —

	GHz	MHz	kHz	Hz	
Observe:	12	300	000	000	MANUAL

(displays new CF momentarily, then returns to measurement display; MAN annunciator goes on)

**Effect:** Sets Manual Center Frequency, turns ON Manual Measurement Mode (INPUT 1, 500 MHz – MAX GHz). Instrument begins to count using new Center Frequency. To exit this mode, press one of the other measurement mode keys.

**Parameter Value Range:** 500 MHz – MAX GHz. If no Manual CF value is entered, the CF remains the last entered value, or defaults to 1 GHz. The CF must be no more than 20 MHz from the frequency to be measured, (within 3 MHz for frequencies below 1 GHz).

### Set Manual Center Frequency to Last Measured Frequency

This procedure describes how to set a Center Frequency (CF) to the last measured frequency while in the manual measurement mode. This may be useful when you want to re-center the signal within the counter's IF. In the example below you are shown how to set a CF of 850 MHz.

**Press:** SET/ENTER, MANUAL, LST VAL

	GHz	MHz	kHz	Hz	
Observe:		850	000	000	MANUAL

(new CF entered, counter begins manual measurement)

**Effect:** Sets Manual CF to value of last measurement, and turns ON Manual Measurement Mode (INPUT 1, 500 MHz – MAX GHz). Instrument begins to count using new Center Frequency. To exit this mode, press one of the other measurement mode keys.

**Parameter Value Range:** Last measurement value must be within 500 MHz – MAX GHz. If last measurement attempt was unsuccessful, the Manual CF remains at the previous setting.

**High/Low  
Measurement Band  
Modes (Option 040  
Only)**

This procedure describes how to use the High and Low Band Measurement Modes available when Option 040 is installed. The optional 500 MHz - 40 GHz frequency range is divided up into two overlapping measurement bands designated High and Low.

The High band frequency range is 12 GHz - 40 GHz. The Low band frequency range is between 500 MHz - 29 GHz. In addition, when the counter is operating in "High" band, the front panel "High" Band annunciator is ON. The example below shows how to switch from one band to the other.

**Press: SET/ENTER, FREQUENCY**

Observe: *LOWER FREQ BAND*

(High band annunciator turns OFF)

**Press: SET/ENTER, FREQUENCY**

Observe: *HIGHER FREQ BAND*

(High band annunciator Turns ON)

**Effect:** Cycles HP 5361B counter equipped with option 040 between High and Low frequency bands.

**Parameter Value Range:** Highband or Lowband

**Power-up Default:** Highband

**Note:** For most measurement applications the High frequency band will make typical pulse measurements all the way down to 500 MHz. Some applications may need acquisition times and pulse width requirements available in Low band only. Refer to Appendix A for exact specifications.

### Low Frequency, 50Ω Measurement Mode

This procedure describes how to use the low frequency 50Ω measurement mode for INPUT 2. The example below shows measurement of a 325 MHz signal.

Press: 50Ω

	GHz	MHz	kHz	Hz
Observe:		325	000	000

(50Ω annunciator goes on)

**Effect:** Turns ON Low Frequency, 50Ω measurement Mode (INPUT 2, 10 MHz – 525 MHz). To exit this mode, press one of the other measurement mode keys; pressing the 50Ω key a second time has no effect.

**Parameter Value Range:** Toggle function.

**Note:** If the frequency of the signal is between 80 MHz and 500 MHz, the 50Ω key must be pressed for correct signal measurement.

### Low Frequency, 1MΩ Measurement Mode

This procedure describes how to use the low frequency 1MΩ measurement mode for INPUT 2. The example below shows measurement of a 50 MHz signal.

Press: 1MΩ

	GHz	MHz	kHz	Hz
Observe:		50	000	000

(1MΩ annunciator goes on)

**Effect:** Turns ON Low Frequency, 1MΩ Measurement Mode (Input 2, 10 Hz – 80 MHz). To exit this mode, press one of the other measurement mode keys; pressing the 1MΩ key a second time has no effect.

**Parameter Value Range:** Toggle function.

**Note:** If the frequency of the signal is between 10 Hz and 10 MHz, the 1MΩ key must be pressed for correct signal measurement.

## MAKING PULSE MEASUREMENTS

This subsection provides you with detailed information on how to make various kinds of pulse measurements. Pulse envelope characteristics and terminology are discussed first followed by pulse measurement procedures.

Detailed information about Gating and Arming is contained in the next subsection. When making Chirp radar measurements, you must use extended function 96 (refer to pages 2-78 and D-6).

### Pulse Envelope Characteristics and Terminology

The HP 5361B can make six different kinds of pulse burst measurements: Pulse Carrier Frequency, Pulse/CW Carrier Frequency Profile, Pulse Width Time, Pulse Off Time, Pulse Repetition Frequency, and Pulse Repetition Interval (time). These measurement functions correspond to the following front panel function keys respectively: FREQUENCY, PROFILE, P WIDTH, OFFTIME, PRF, and PRI (1/PRF). The relationships of these parameters are shown in *Figure 2-1, Pulse and CW Signal Parameters*, and summarized in *Table 2-3, Pulse and CW Signal Parameters*.

Figure 2-1.  
Pulse and  
CW Signal  
Parameters

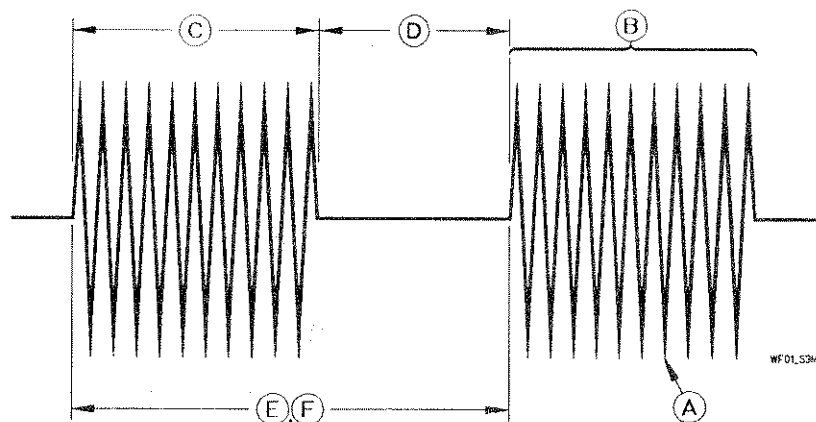

Table 2-3. Pulse and CW Signal Parameters

Measurement	Pulse/Frequency Function	Key
Pulse Frequency or CW	FREQUENCY	A
Profile Frequency Modulation	PROFILE	B
Pulse Width	P WIDTH	C
Pulse Off Time	OFFTIME	D
Pulse Repetition Interval	PRI (1/PRF)	E
Pulse Repetition Frequency	PRF	F

- A) Pulse Frequency (Pulse Carrier) is measured in cycles per second (Hertz).
- B) Pulse "Profile" is the successive change in pulse carrier frequency from the onset of the pulse to its end (Time vs Hertz).
- C) Pulse Width is defined as the time interval from the leading edge to the trailing edge of a single pulse.
- D) Pulse Off Time is defined as the time interval between two pulses, measured from the trailing edge of the first pulse to the leading edge of the second.
- E) Pulse Repetition Interval is defined as the time interval between the leading edges of two consecutive pulses and is the reciprocal value of the pulse repetition frequency (1/PRF).
- F) Pulse Repetition Frequency is defined as the number of pulses per second (Hertz).

### Selecting Pulse Measurement Characteristics

The following instructions describe how to select and make each of the six pulse burst parameter measurements explained above. The three front panel pulse function keys operate by toggling between functions for all six measurement functions. The counter returns to the last selected function on these keys. For example, selecting OFFTIME, then FREQUENCY, then pressing P WIDTH/OFFTIME turns on the Offtime function.

Each tutorial operating procedure shows the key (or key sequence, as necessary) to be pressed to perform the desired function, and the resultant display. A brief description of the effect of each function is given, and the allowable range for any parameter values are described, if applicable. The Power-up default conditions for each function are also given, with the term "Power-up" referring to connecting ac power to the instrument and then turning it on, as distinct from "Standby", which assumes that ac power is continuously connected.

**INPUT 1 Pulse  
Measurements  
(500 MHz –  
MAX GHz)**

All pulse measurements are made via INPUT 1 using a type N Female or APC 3.5 Male connector. When you're preparing to measure a signal with this input always ensure that the following conditions have been met:

- a. Signal input power is no greater than +7 dBm (NEVER EXCEEDING +25 dBm – DAMAGE LEVEL).
- b. Signal input impedance must be 50Ω for correct termination and front-end operation.
- c. When a pulsed microwave signal with a pulse repetition frequency less than 50 Hz is present, the "<50 Hz PRF" mode must be entered (Refer to page 2-36 of this section.) with the counter in Manual mode.
- d. When a pulsed microwave signal with a pulse width less than 100 nanoseconds is present, the "<100 ns Pulse" mode must be entered by using Extended Function 93 after placing the counter in manual mode (Refer to pages 2-58 and 2-76 of this section.).

When these conditions have been met, use the following procedures to obtain the pulse measurements you need.

**PULSE FREQUENCY  
(FREQUENCY)**

This procedure describes how to measure the average frequency within a typical pulsed signal. See callout "A" of *Figure 2-1* for a graphic description of this parameter and *Table 2-3* for a front panel function key summary.

The example below shows you how to measure a pulse burst carrier frequency of 18 GHz. (The power-up condition does not display digits for kHz/Hz.)

Press: **FREQUENCY**

Observe: *FREQUENCY MEASUREMENT*

— then —

GHZ	MHZ	KHZ	HZ
Observe: 18	000		<i>PULSE</i>

**Effect:** Turns ON Pulse or CW Frequency Measurement function (INPUT 1: 500 MHz – MAX GHz) if the Frequency

function is Inactive. To exit this function press one of the other pulse measurement function keys: pressing the FREQUENCY key a second time initiates the Auto Profile measurement process. The instrument powers-up ready to measure frequency and does so when a pulse burst signal is present at INPUT 1.

**Parameter Value Range:** ON function only

**Power-up Default:** ON when pulse signal is present

**Note:** The Pulse Frequency function is active only when a pulsed microwave signal is present at INPUT 1 or if Extended function 92 is selected and locked in "Pulse Only" mode, forcing the counter to present the "FREQUENCY MEASUREMENT" display as shown above.

**PULSE PROFILE (PROFILE)**

This procedure describes how to measure the frequency profile within a typical pulsed or CW sweep signal. See callout "B" of Figure 2-1 for a graphic description of this parameter and Table 2-3 for a front panel function key summary.

Before going further, be sure you've set up the counter as described in the Auto Pulse Profiling procedure described in Section I of this manual. (The counter must be in "HOLD" mode prior to the keystrokes shown below.) The example below shows you the front panel keystrokes and messages used when profiling a pulse burst at 22 GHz.

**Press: PROFILE, TRIGGER**

**Observe: PROFILING- - -**

(This message appears while the counter is measuring and calculating results.)

— then —

**Observe: PRINTING PLOT- - -**

(This message appears while the counter outputs graphic measurement results to the printer.)

— or —

Observe: *PRINTING TABLE* - - -

(This message appears while the counter outputs tabular measurement results to the printer.)

— then —

	GHz	MHz	kHz	Hz	
Observe:	22	000	000	000	PROFILE

(After printer output is complete, counter displays the average pulse frequency.)

**Effect:** Turns ON Pulse or CW Sweep Frequency Profile Measurement function (INPUT 1: 500 MHz – MAX GHz). To exit this function press the PROFILE key a second time. During printing of either profile plot or table, the keyboard is locked out. The instrument powers-up ready to enter this function and does so when a pulse burst signal is present at INPUT 1 and the FREQUENCY/PROFILE key has been toggled to the Profile function.

**Parameter Value Range:** ON function only

**Power-up Default:** OFF

**Note:** The Pulse Frequency Profile function is active only when a pulsed microwave signal is present at INPUT 1 or if a CW Sweep signal is present along with an external gate supplied to the front panel Gate/Arm In BNC connector. (See External Gating in this section or appendix D.) You can also use external gating for pulse profiling when the pulses are longer than 10 ms or you need to profile all the way to the end of the pulse.

Obtain the hardcopy output by setting the counter's HP-IB address to 31 (TALK ONLY mode) and the printer to LISTEN ALWAYS mode. No other devices can be present on the HP-IB interface, otherwise the bus will hang. If the printer has not been correctly configured or connected to the HP-IB, you can exit the profile printing process only by cycling power to the counter.

If you choose to manually control the profiling setup parameters and then erroneously input invalid values or parameter combinations, a plot error will occur. The counter



will be unable to generate a plot and the message "PLOT ERROR" will be printed out alongside the text legend of the plot. When this occurs, all parameters are set to "0" and the display shows all "0".

During Math overflow, the "MATH OVERFLOW" message is displayed at the end of profiling. The same message is also printed out on the text portion of the plot or table hardcopy.

**PULSE WIDTH (P WIDTH)**

This procedure describes how to measure the pulse width (P WIDTH) of microwave RF pulse bursts. Pulse Width is defined as the time interval measured from the leading edge to the trailing edge of a single pulse. See callout "C" of Figure 2-1 for a graphic description of this parameter and Table 2-3 for a front panel function key summary.

The example below shows you how to measure a pulse width of a 530 microsecond RF burst.

**Press: P WIDTH**

**Observe: PULSE WIDTH**

— then —

	GHz	MHz	kHz	Hz	
<b>Observe:</b>	530.	000	MICRO	SEC	PW

**Effect:** Turns ON Pulse Width Measurement function (INPUT 1, 500 MHz – MAX GHz).

To exit this function, press the key again or one of the other pulse measurement function keys: pressing the P WIDTH key a second time toggles the counter to the alternate function OFFTIME. The instrument powers-up ready to enter P WIDTH and does so when a pulse burst signal is present at INPUT 1 and the P WIDTH key is pressed.

**Parameter Value Range:** ON function only

**Power-up Default:** OFF

**Note:** The Pulse Width function is displayed only when a pulsed microwave signal is present at INPUT 1 or if Extended function 92 is selected and locked in "Pulse Only" mode, forcing the counter to make pulse measurements.

**PULSE OFF TIME  
(OFFTIME)**

This procedure describes how to measure the pulse off time (OFFTIME). Pulse Off Time is defined as the time interval between two pulses, measured from the trailing edge of the first pulse to the leading edge of the second. See callout "D" of Figure 2-1 for a graphic description of this parameter and Table 2-3 for a front panel function key summary.

The example below shows you how to measure a pulse burst off time of 470 microseconds.

**Press: OFFTIME**

**Observe: PULSE OFF TIME**

— then —

	GHz	MHz	kHz	Hz	
<b>Observe:</b>	470.	000	MICRO	SEC	OFF

**Effect:** Turns ON Pulse Off Time Measurement function (INPUT 1, 500 MHz – MAX GHz). To exit this function press the key again or one of the other pulse measurement function keys: pressing the OFFTIME key a second time toggles the counter to the alternate function P WIDTH. The instrument powers-up ready to enter OFFTIME and does so when a pulse burst signal is present at INPUT 1 and the OFFTIME key is pressed.

**Parameter Value Range:** ON function only

**Power-up Default:** OFF

**Note:** The Pulse Off Time function is displayed only when a pulsed microwave signal is present at INPUT 1 or if Extended function 92 is selected and locked in "Pulse Only" mode, forcing the counter to make pulse measurements.

**PULSE REPETITION  
INTERVAL (PRI)**

This procedure describes how to measure the pulse repetition interval (PRI) of a burst within a typical pulsed signal. Pulse Repetition Interval is defined as the time between the leading edges of two consecutive pulses and is the reciprocal value of the pulse repetition frequency (1/PRF). When the counter is in the external ARM mode, this interval is the time between any two consecutive pulses within the RF burst as measured

between the falling edge of the first ARM signal and the falling edge of the next ARM signal. See callout "E" of *Figure 2-1* for a graphic description of this parameter and *Table 2-3* for a front panel function key summary.

The example below shows you how to measure a pulse burst PRI of 1.000 millisecond.

**Press: PRI**

**Observe: PULSE REP INTERVAL**

— then —

		GHz		MHz		KHz		Hz	
Observe:		1.		000		0		MILLI SEC	PRI

**Effect:** Turns ON PRI Measurement function (INPUT 1, 500 MHz – MAX GHz). To exit this function press the key again or one of the other pulse measurement function keys: pressing the PRI key a second time toggles the counter to the alternate function PRF. The instrument powers-up ready to enter PRI and does so when a pulse burst signal is present at INPUT 1 and the PRI key is pressed.

**Parameter Value Range:** ON function only

**Power-up Default:** OFF

**Note:** The PRI function is displayed only when a pulsed microwave signal is present at INPUT 1 or if Extended function 92 is selected and locked in "Pulse Only" mode, forcing the counter to make pulse measurements.

**PULSE REPETITION  
FREQUENCY (PRF)**

This procedure describes how to measure the pulse repetition frequency (PRF) of a burst within a typical pulsed signal. Pulse repetition frequency is defined as the number of pulses per second (Hertz). See callout "F" of *Figure 2-1* for a graphic description of this parameter and *Table 2-3* for a front panel function key summary.

The example below shows you how to measure a pulse burst PRF of 999 Hz.

Press: **PRF**

Observe: *PULSE REP FREQ*

— then —

	GHz	MHz	kHz	Hz	
Observe:	___	___	___	999	PRF

**Effect:** Turns ON PRF Measurement function (INPUT 1, 500 MHz – MAX GHz). To exit this function press the key again or one of the other pulse measurement function keys: pressing the PRF key a second time toggles the counter to the alternate function PRI. The instrument powers-up ready to enter PRF and does so when a pulse burst signal is present at INPUT 1 and the PRF key is pressed.

**Parameter Value Range:** ON function only

**Power-up Default:** OFF

**Note:** The PRF function is displayed only when a pulsed microwave signal is present at INPUT 1 or if Extended function 92 is selected and locked in "Pulse Only" mode, forcing the counter to make pulse measurements.

**LOW PULSE REPETITION  
FREQUENCY  
MEASUREMENT MODE  
(<50 Hz PRF)**

This procedure shows you how to turn on the <50 Hz PRF measurement mode. Use of this mode must be preceded by entry into the Manual mode. This mode is needed when the INPUT 1 pulsed microwave signal falls below 50 Hz. The <50 Hz PRF mode enables the counter to distinguish this low PRF rate from a switched CW input. (An IF AGC loop settling time of up to 120 seconds may occur during the use of this mode.)

Press: **SET/ENTER, PRF**

	GHz	MHz	kHz	Hz	
Observe:	LOW	PRF	MODE	ON	

(displays mode message, <50 Hz PRF annunciator goes on)

Press: **SET/ENTER, PRF**

	GHz	MHz	kHz	Hz
Observe:	LOW	PRF	MODE	OFF

(displays mode message, <50 Hz PRF annunciator goes off)

**Effect:** Turns <50 Hz PRF mode ON and OFF. When turned ON, pulsed signals with a PRF <50 Hz present at INPUT 1 are accurately measured.

**Parameter Value Range:** ON or OFF

**Power-up Default Value:** OFF

**Note:** Before entering this mode you must be in the Manual measurement mode. Entry to the Manual measurement mode is made by using the MANUAL key.

## GATING AND ARMING

This subsection shows you how to use the GATE MODE key along with the front panel GATE/ARM IN connector. The key cycles through the gate modes when pressed repeatedly. Three Gate modes are available to the HP 5361B: Arm mode, External mode, and Internal mode.

Gating is used to specify the beginning and the end of a measurement within the RF pulse burst or CW signal. In the Internal gate mode, the counter decides when to start and stop a measurement on the input signal. In the External or Arm gate mode, a signal is acquired and measured using the user supplied input signal.

The External and Arm modes are used for pulse profiling and remote control of the instrument's gate for other applications that use auxiliary equipment. Internal mode provides the necessary gating for pulse frequency measurement function described previously. During Arm or External modes, the counter's internal gating circuits are under control of the Gate/Arm signal provided through the front panel GATE/ARM IN connector.

Each tutorial operating procedure shows the key (or key sequence, as necessary) to be pressed to perform the desired function, and the resultant display. A brief description of the effect of each function is given, and the allowable range for any parameter values are described, if applicable. The

Power-up default conditions for each function are also given, with the term "Power-up" referring to connecting ac power to the instrument and then turning it on, as distinct from "Standby", which assumes that ac power is continuously connected.

### Internal Gating

The counter normally uses internal gating when you need to measure the six pulse measurement functions available via the front panel function keys: FREQUENCY, PROFILE, P WIDTH, OFFTIME, PRF, and PRI. The input signal must consist of a continuous train of pulse bursts (Refer to Appendix A for minimum PRF specifications).

The following procedure shows how you can turn-on Internal gating using the GATE MODE key from the current gate mode of either ARM or EXTERNAL (Power-up default is INTERNAL gate mode).

Press: **GATE MODE**

(as needed)

Observe:

▼  
INT

(INTERNAL GATE message appears momentarily and annunciator appears over "INT")

**Effect:** Turns-on Internal gate mode. To exit this function press the GATE MODE key again.

**Parameter Value Range:** ON function only

**Power-up Default:** ON

**Note:** When the Internal gate mode is active, signal inputs at the GATE/ARM IN connector have no effect.

### External Gating

Use external gating for pulse frequency/CW sweep profiling or to remotely control the instrument's gate in other pulse/CW measurement applications. External gating requires you to provide a TTL signal to the GATE/ARM IN connector from an external source. The GATE/ARM IN connector type is BNC Female, gate input is active low, and the input impedance is 1.5 k $\Omega$  at +3.5 volts.

The following procedure shows how you can turn-on External gating using the GATE MODE key and also explains how to input an external gate through the GATE/ARM IN connector.

Press: **GATE MODE**

(once or twice as needed)

Observe: ▼  
EXT

(EXTERNAL GATE message appears momentarily and annunciator appears over "EXT")

**Effect:** Turns-on External gate mode. To exit this function press the GATE MODE key again.

**Parameter Value Range:** ON function only

**Power-up Default:** OFF

**Note:** When the External gate mode is active, measurement is controlled by the level of the signal provided at the GATE/ARM IN connector. A gate signal must be supplied to the counter to enable pulse or CW measurements.

Here's how to connect and use the GATE/ARM IN connector for external gating:

1. Ensure that the signal input to the GATE/ARM IN connector is TTL (0 – 5 volts).
2. Ensure that the signal input to the GATE/ARM IN connector terminates properly with a 1.5 k $\Omega$  input impedance. (Apply an external 50  $\Omega$  load to terminate 50  $\Omega$  source.)
3. Ensure that the signal supplied as the external gate is active low (Negative logic) and is at least 20 nanoseconds wide (See *Figure 3-5, Gate/Arm In waveforms*, on page 3-21 for more information).
4. Connect the external gate line to the front panel GATE/ARM IN connector using a BNC Male connector.

5. Program the HP 5361B to make the measurements you need by using the front panel control keys or HP-IB remote instrument commands.
6. Provide a signal (Pulse or CW) you need to measure at INPUT 1 and the external gating signal at the GATE/ARM IN connector.
7. Observe the displayed measurement or collect the measurement data via HP-IB.

### Arming

Use Arming when you need to individually trigger each measurement in a train of pulse bursts. Arming allows you to make a measurement of a unique pulse within the pulse burst. You must provide a TTL signal to the GATE/ARM IN connector from some external source. The GATE/ARM IN connector type is BNC Female, trigger input is active on the falling edge, and the input impedance is 1.5 k $\Omega$  at +3.5 volts.

The following procedure shows how you can turn-on Arming using the GATE MODE key and also explains how to input an arming signal through the GATE/ARM IN connector.

Press: **GATE MODE**

(once or twice as needed)

Observe:

▼  
**ARM**

(ARM GATE message appears momentarily and annunciator appears over "ARM")

**Effect:** Turns-on Arm gate mode. To exit this function press the GATE MODE key again.

**Parameter Value Range:** ON function only

**Power-up Default:** OFF

**Note:** When the Arm gate mode is active, measurement sampling is controlled by the falling edge of the signal provided at the GATE/ARM IN connector. An arming signal must be supplied to the counter to enable pulse measurements.



Here's how to connect and use the GATE/ARM IN connector for arming:

1. Ensure that the signal input to the GATE/ARM IN connector is TTL (0 – 5 volts) with at least two arming edges provided for all pulse envelope measurements except PW (only one required).
2. Ensure that the signal input to the GATE/ARM IN connector terminates properly with a 1.5 k $\Omega$  input impedance.
3. Ensure that the signal supplied for arming is active on the falling edge. Also, the target pulse onset must follow arm edge by at least 50 nanoseconds (See *Figure 3-5, Gate/Arm In waveforms*, on page 3-21 for more information).
4. Connect the external arm line to the front panel GATE/ARM IN connector using a BNC Male connector.
5. Program the HP 5361B to make the measurements you need by using the front panel control keys or HP-IB remote instrument commands.
6. Provide a pulsed microwave signal you need to measure at INPUT 1 and the arming signal at the GATE/ARM IN connector.
7. Observe the displayed measurement or collect the measurement data via HP-IB.

## USING MEASUREMENT MODIFIERS

This subsection provides you with detailed information on how to use the HP 5361B measurement modifiers: Resolution, High Resolution, Pulse Averaging, Sample Rate, Trigger, and FM Rate/Track. All functions except High Resolution and Pulse Averaging correspond to the labeled front panel keys. High Resolution is called via extended function 94 while Pulse Averaging is available via the Resolution key during pulse envelope measurements.

Each tutorial operating procedure shows the key (or key sequence, as necessary) to be pressed to perform the desired function, and the resultant display. A brief description of the effect of each function is given, and the allowable range for any parameter values are described, if applicable. The Power-up default conditions for each function are also given,

with the term "Power-up" referring to connecting ac power to the instrument and then turning it on, as distinct from "Standby", which assumes that ac power is continuously connected.

**Power-up Default Values:**

The power-up default measurement modifier values for the HP 5361B are listed below:

Resolution	- 1 Hz for INPUT 2/ 1 MHz for INPUT 1
High Resolution	- OFF
Pulse Averaging	- 1 (OFF)
Sample Rate	- FAST
Trigger	- Not applicable
FM Rate/Track	- NORMAL

**Resolution**

You can change the number of significant digits displayed for measurements by using the RESOLUTION key. For frequency resolution, the non-significant digits of a measurement are rounded off and shown either blank or replaced by the asterisk symbol \*, depending on the resolution.

**CHECK RESOLUTION**

The example below shows how to display a current resolution of 10 kHz, for a measurement of 50.00 MHz

Press: **RESOLUTION**

	GHz	MHz	kHz	Hz	
Observe:	00	000	01*	***	RESOL

(displays current resolution)

— then —

	GHz	MHz	kHz	Hz	
		50	00*		

(measurement at 10 kHz resolution)

**Effect:** Displays current resolution setting as long as RESOLUTION key is held down.

**Parameter value range:** Display function

**Power-up Default:** 1 Hz for INPUT 2/ 1 MHz for INPUT 1

**Note:** When a group of three digits in the display is suppressed due to the resolution setting, all three digits are blanked. If only one or two digits in a three digit group are suppressed, the suppressed digits are replaced with asterisks\*.

**SET RESOLUTION**

The example below shows you how to change resolution from 1 Hz to 1 MHz. The counter is assumed to be measuring a pulsed 1.234567890 GHz signal. When the resolution you set cannot be obtained, "PULSE \*\*" is shown on the right side of the display.

**Press: SET/ENTER, RESOLUTION**

	GHz	MHz	kHz	Hz	
Observe:	00	000	000	001	RESOL

(displays current resolution setting)

**Press: DEC**

(press key 6 times, or hold key down)

	GHz	MHz	kHz	Hz	
Observe:	00	000	000	01*	RESOL
	00	000	000	1**	RESOL
	00	000	001	***	RESOL
	00	000	01*	***	RESOL
	00	000	1**	***	RESOL
	00	001	***	***	RESOL

**Press: SET/ENTER**

	GHz	MHz	kHz	Hz	
Observe:	1	235			

(begins counting with 1 MHz resolution)

**Effect:** Sets the resolution for INPUT 1 or INPUT 2 measurements.

**Parameter Value Range:** 1 Hz to 1MHz, in decade steps.

## High Resolution

You can obtain a resolution greater than 1 Hz for measurements below 10 MHz by using the High Resolution function. This function applies only to INPUT 1 PRF and INPUT 2, 1M $\Omega$  measurements. INPUT 2 gate time remains constant at 1 second during High Resolution measurements. The Smooth function takes precedence over High Resolution. The High Resolution function takes precedence over the normal counter resolution, if the counter is in the INPUT 2, 1M $\Omega$  measurement mode. High Resolution is obtained by calling Extended function 94 after RESOLUTION has been set to 1 Hz.

The example below shows you how to turn on High Resolution while making a 1 M $\Omega$  (INPUT 2) measurement of 5,000,000.000 Hz, then turn High Resolution off.

**Press:** SET/ENTER, EXTEND FUNCT, 9, 4, SET/ENTER

**Observe:** HIGH RESOL ON

(displays message momentarily)

— then —

GHz	MHz	kHz	Hz
	5	000	000.0**

(measurement with High Resolution in effect)

**Effect:** Turns High Resolution function ON and OFF. Displays "HIGH RESOL ON" message momentarily. The High Resolution function begins as soon as Set/Enter is pressed for the second time. The function terminates when a different extended function is selected or when the extended function mode is exited.

**Parameter Value Range:** None, toggle function only

**Power-up Default:** OFF

**Note:** The High Resolution function can only be applied to INPUT 1 PRF and INPUT 2, 1M $\Omega$  impedance measurements (10 Hz – 80 MHz). The Smooth function takes precedence over

the High Resolution function for INPUT 2 1 MΩ impedance measurements.

The higher resolution obtained using this function depends on the input frequency, as shown in *Table 2-4* (where  $F_{in}$  = input frequency). Resolution is displayed in millihertz (3 digits to the right of the decimal point) for PRF measurements.

## Pulse Averaging

*Table 2-4. High Resolution Displays*

Frequency Range	Resolution	Display Example				
		GHz	MHz	kHz	Hz	
80 MHz $\geq F_{in} \geq 10$ MHz	1 Hz		15	000	000.	
10 MHz $> F_{in} \geq 1$ MHz	0.1 Hz		1	500	000.	0**
1 MHz $> F_{in} \geq 0.1$ MHz	0.01 Hz			150	000.	00*
0.1 MHz $> F_{in} \geq 10$ Hz	0.001 Hz			15	000.	000

You can obtain greater resolution during pulse measurements by using the Pulse Averaging measurement modifier. The use of Pulse averaging may also result in enhanced least significant digit (LSD) display stability/readability. Pulse averaging can be performed over a wide range of pulse measurement samples: from 2 to 9,999 (with a default of 1). The AVG (Average) annunciator appears only if the selected averaging value is greater than 1 and applies only to pulse envelope parameter averaging, not carrier frequency averaging.

Average measurements can be obtained for all pulse measurement parameters. Pulse carrier frequency averaging is performed via EFUN 91 and can be selected to facilitate the use of a specific set resolution. Procedures for checking and changing the current pulse average value are described below.

If the total accumulated measurement time for a measurement exceeds 20 seconds, the count may not be accurate. You must ensure that the number of averages times the envelope parameter time does not exceed 20 seconds.

**CHECK PULSE  
AVERAGING VALUE**

The example below shows how to display the current pulse average modifier value during pulse measurement mode while a pulse envelope measurement function is active.

Press: **SET/ENTER, RESOLUTION**

	GHz	MHz	kHz	Hz	
--	-----	-----	-----	----	--

Observe: 1 AVERAGE

(displays current average)

**Effect:** Displays current average setting until the SET/ENTER key is pressed again.

**Parameter value range:** Display function only

**Power-up Default:** 1

**Note:** The "Preset" function clears the current average value and returns the default value of 1. Preset the counter by pressing SET/ENTER, then RESET. Preset also clears all other front panel setup values in addition to averaging.

**SET A NEW  
PULSE AVERAGE**

The example below shows how to change the current pulse average modifier value during pulse measurement mode with a pulse envelope measurement function active. In this example the default value is changed from 1 to 10.

Press: **SET/ENTER, RESOLUTION**

	GHz	MHz	kHz	Hz	
--	-----	-----	-----	----	--

Observe: 1. AVERAGE

(displays current average)

Press: **1, 0, SET/ENTER**

	GHz	MHz	kHz	Hz	
--	-----	-----	-----	----	--

Observe: 10. AVERAGE

(displays new average momentarily then returns to current measurement function AVG annunciator goes on)

**Effect:** Changes current average setting to new entered value.

Parameter value range: 1 to 9,999

Power-up Default: 1

**Note:** The "Preset" function clears the current average value and returns the default value of 1. Preset the counter by pressing SET/ENTER, then RESET. Preset also clears all other front panel setup values in addition to averaging.

### Sample Rate

You can use the Sample Rate modifier to set the "dead time" between measurements. The minimum time (Fast) allows the instrument to count as frequently as possible. The other extreme (Hold) keeps the last measurement until you start a new measurement by pressing the TRIGGER key. The following procedures show you how to check and change the HP 5361B Sample Rate.

#### CHECK SAMPLE RATE

Use this procedure to check the counter's current Sample Rate. This example displays a sample rate setting of approximately 1.0 second.

Press: **SAMPLE RATE**

Observe: *HOLD - - - - - \* - - FAST SMPL RT*

(current sample rate of 1.0 seconds is displayed)

**Effect:** Display current sample rate setting as long as SAMPLE RATE key is held down.

**Parameter Value Range:** Display function.

**Power-up Default Value:** FAST

**Note:** The Sample Rate function sets the dead time between measurements. Total measurement time, or repetition rate, is affected by the measurement mode and other functions, as well as the input signal PRF pulse width during pulse measurements. Using EFUN 92 to force Pulse only or CW measurement only is recommended for "HOLD" measurements (refer to page 2-76). If the default EFUN 92 condition "AUTO" is used, the first measurement may be "0" if the signal present at INPUT 1 changes from CW to pulse or vice versa.

**SET A NEW  
SAMPLE RATE**

Use this procedure to change the counter's current Sample Rate. This example changes a sample rate setting from FAST to HOLD.

Press: **SET/ENTER, SAMPLE RATE**

Observe: *HOLD* - - - - - > *FAST SMPL RT*

(current sample rate is displayed)

Press: **DEC**

(press seven times or hold down)

Observe: *HOLD* - - - - - \* - *FAST SMPL RT*  
(0.5 sec.)

*HOLD* - - - - - \* - - *FAST SMPL RT*  
(1.0 sec.)

*HOLD* - - - - - \* - - - *FAST SMPL RT*  
(1.5 sec.)

*HOLD* - - - - \* - - - - *FAST SMPL RT*  
(3.0 sec.)

*HOLD* - - - \* - - - - - *FAST SMPL RT*  
(5.0 sec.)

*HOLD* - \* - - - - - *FAST SMPL RT*  
(10.0 sec.)

*HOLD* < - - - - - *FAST SMPL RT*  
(HOLD annunciator goes on)

Press: **SET/ENTER**

Observe: *HOLDING* - - - -

(no measurement made until triggered)

**Effect:** Sets sample rate for INPUT 1 and INPUT 2 measurements by using the INC and DEC keys along with the SET/ENTER and SAMPLE RATE keys.



**Parameter Value Range:** Fast, 0.5 seconds, 1.0 seconds, 1.5 seconds, 3.0 seconds, 5.0 seconds, 10.0 seconds, Hold.

**Power-up Default Value:** FAST

**Note:** The Sample Rate function sets the dead time between measurements. Total measurement time, or repetition rate, is affected by the measurement mode and other functions, as well as the input signal.

### Trigger

Once you've set the sample rate to HOLD, you can manually trigger a single measurement by using the front panel TRIGGER key. The example below shows you how to trigger and hold a measurement of 25.000 000 MHz

**Press: TRIGGER**

	GHz	MHz	kHz	Hz
Observe:		25	000	000

(Measurement taken and held, HOLD annunciator remains on)

**Effect:** If sample rate is set to Hold, triggers a measurement, otherwise restarts measurement.

**Parameter Value Range:** None

**Power-up Default Value:** None

### FM Rate/Track

You can use the FM Rate/Track function to optimize acquisition of FM CW signals at INPUT 1 while in the Auto mode. The FM RATE/TRACK key lets you select three different acquisition methods for use during high frequency CW measurements. They are: Normal Rate, Low Rate, and Track. These options let you improve signal tracking or compensate for very low FM rates.

The Low Rate ensures acquisition of FM signals with rates as low as 45 Hz, and high deviation by increasing the gate times. Track mode acquires signals with FM rates equal to or greater than 300 kHz and high deviation.

The procedure below shows you how to use the FM RATE/TRACK key to change the acquisition methods and what to expect on the display.

**Press: FM RATE/TRACK**

**Observe:** *LOW FM Rate*

(displays message momentarily, then returns to measurement display; LOW annunciator on, FM NORM and TRACK annunciators off)

**Press: FM RATE/TRACK**

**Observe:** *FAST ACQ/TRACK*

(displays message momentarily, then returns to measurement display; TRACK annunciator on, FM NORM and LOW annunciators off)

**Press: FM RATE/TRACK**

**Observe:** *NORMAL FM RATE*

(displays message momentarily, then returns to measurement display; FM NORM annunciator on, LOW and TRACK annunciators off)

**Effect:** Sets FM Rate/Track function to Low Rate, Track, or Normal Rate

**Parameter Value Range:** Three-way toggle function.

**Power-up Default Value:** Normal FM Rate

**Note:** This function applies only to CW measurements in Auto mode (INPUT 1, 500 MHz-MAX GHz). All FM annunciators are OFF for pulsed measurements.

**MATH MODIFIERS**

This subsection provides you with detailed information on how to use the HP 5361B math modifiers: Offset, Scale, and Smooth. Each modifier corresponds to a front panel key in the math group.

Each tutorial operating procedure shows the key (or key sequence, as necessary) to be pressed to perform the desired function, and the resultant display. A brief description of the effect of each function is given, and the allowable range for any parameter values are described, if applicable. The Power-up default conditions for each function are also given, with the term "Power-up" referring to connecting ac power to the instrument and then turning it on, as distinct from "Standby", which assumes that ac power is continuously connected.

**Power-up Default Values**

The power-up default math modifier values for the HP 5361B are listed below:

Offset	– OFF, 0 Hz
Scale	– OFF, 1.000
Smooth	– OFF

**Offset**

The Offset modifier lets you add or subtract a value to/from the calculated results that would normally appear on the display. During pulse repetition, CW frequency, or pulse frequency measurements, the offset is entered and displayed in Hertz. During pulse envelope measurements (P WIDTH, OFFTIME, PRI), the offset is entered and displayed in milliseconds, microseconds, or nanoseconds.

**TURN ON OFFSET**

This procedure shows you how to turn on the offset math modifier. The example shown below is valid for INPUT 1 CW, pulse envelope, or pulse frequency measurements and works in the same way for frequency measurements made through INPUT 2. Offset values may be entered for either pulse envelope (time: in ms/ $\mu$ s/ns) or frequency measurements (hertz). The example below applies a previously entered negative 2 GHz offset value to a measurement of 12 GHz.

Press: **OFFSET**

	GHz	MHz	kHz	Hz	
Observe:	-2	000	000	000	OFFSET

(displays current offset momentarily; OFFSET annunciator goes on)

— then —

	GHz	MHz	kHz	Hz	
Observe:	10	000	000	000	

(12 GHz measurement with -2 GHz offset applied)

**Effect:** Turns offset function ON and OFF. When turned ON, current offset is displayed. When the OFFSET key is released, display shows the sum of the current measurement plus the offset. Press the key a second time to turn the Offset function back to OFF.

**Parameter Value Range:** Toggle function.

**Power-up Default Value:** OFF

**SET A NEW  
OFFSET VALUE**

This procedure shows you how to set a new offset value. The example shown below is valid for INPUT 1 CW, pulse envelope, or pulse frequency measurements and works in the same way for frequency measurements made through INPUT 2. Offset values may be entered for either pulse envelope (time: in ms/ $\mu$ s/ns) or frequency measurements (Hertz). The example below changes a current offset value from 2 GHz to -35.5 MHz, and then applies it to a 600 MHz measurement.

Press: SET/ENTER, OFFSET

	GHz	MHz	kHz	Hz	
Observe:	2	000	000	000	OFFSET

(displays current offset value)

Press: 3, 5, \*, 5, ±

	GHz	MHz	kHz	Hz	
Observe:		-35.5			OFFSET

Press: SET/ENTER

	GHz	MHz	kHz	Hz	
Observe:		-35.	500	000	OFFSET

(displays new offset momentarily, then measurement begins with offset applied; OFFSET annunciator goes on)

— then —

	GHz	MHz	kHz	Hz	
		564	500	000	

(600 MHz measurement with - 35.5 MHz offset applied)

**Effect:** Sets Offset value, and turns ON the Offset function. To turn OFF the Offset function, press the OFFSET key again.

**Parameter Value Range:** 0 Hz to ±999.999999999  
GHz/MHz/kHz/ms/μs/ns

**Power-up Default Value:** OFF

**Note:** When entering an offset value, the sign may be changed at any point in the key sequence using the sign (±) key.

**SET OFFSET TO  
LAST VALUE**

This procedure shows you how to set the offset to the last measured value. The example shown below is valid for INPUT 1 CW, pulse envelope, or pulse frequency measurements and works in the same way for frequency measurements made through INPUT 2. Offset values may be entered for either pulse envelope (time: in ms/ $\mu$ s/ns) or frequency measurements (hertz). The example below changes a current offset value from -35.5 MHz to a negated last measurement value of 200.000 000 MHz.

**Press: SET/ENTER, OFFSET**

	GHZ	MHz	kHz	Hz	
Observe:		-35	500	000	OFFSET

(display shows current offset)

**Press: LST VAL**

	GHZ	MHz	kHz	Hz	
Observe:		-200	000	000	OFFSET

(display shows negated value of last measurement)

**Press: SET/ENTER**

	GHZ	MHz	kHz	Hz	
Observe:	-N-	-N-	-N-	-N-	

(displays measurement with offset applied: OFFSET annunciator goes on)

**Effect:** Sets Offset to last measured value, and turns ON the Offset function. To turn OFF the Offset function, press the OFFSET key again.

**Parameter Value Range:** Last measured value must be within 0 Hz to  $\pm 999.999999999$  GHz/MHz/kHz/ms/ $\mu$ s/ns.

**Power-up Default Value:** -0.00

**Scale** The Scale modifier lets you multiply the calculated results by a selected multiplier. To multiply, use a whole or mixed decimal number. To simulate division, use a decimal fraction. When simulating division, the accuracy of scaled results may vary greater than  $\pm 1$  least significant digit (LSD). During all measurements, the scale factor is entered and displayed with no associated unit of measurement.

**TURN ON SCALE FACTOR** This procedure shows you how to turn on the scale math modifier. The example shown below is valid for INPUT 1 CW, pulse envelope, or pulse frequency measurements and works in the same way for frequency measurements made through INPUT 2. The example below applies a current scale factor of 1.5 to a 600 MHz measurement.

Press: **SCALE**

	GHz	MHz	kHz	Hz	
Observe:				1.500	SCALE

(display shows current scale factor)

— then —

	GHz	MHz	kHz	Hz	
Observe:		900	000	000	

(measurement with scale factor applied; SCALE annunciator goes on)

**Effect:** Turns Scale function ON and OFF. When turned ON, current scale factor is displayed. When the SCALE key is released, display shows the product of the current input signal measurement multiplied by the scale factor.

**Parameter Value Range:** ON or OFF

**Power-up Default Value:** OFF

**SET A NEW  
SCALE FACTOR**

This procedure shows you how to set a new scale factor. The example shown below is valid for INPUT 1 CW, pulse envelope, or pulse frequency measurements and works in the same way for frequency measurements made through INPUT 2. The example below changes a current scale factor from 1.5 to -0.001 for a 600 MHz measurement.

Press: **SET/ENTER, SCALE, •, 0, 0, 1, ±**

GHZ	MHZ	kHz	Hz
Observe: <span style="float: right; font-family: monospace;">-0.001 SCALE</span>			

(display shows new scale factor)

Press: **SET/ENTER**

GHZ	MHZ	kHz	Hz
Observe: <span style="float: right; font-family: monospace;">-600 000</span>			

(measurement with scale factor applied; SCALE annunciator goes on)

**Effect:** sets scale value, and turns ON the Scale function. To turn the Scale function OFF, press the SCALE key again.

**Parameter Value Range:** ±0.0001 to ±9999 (except 0: if 0 is entered, scale value defaults to +1).

**Power-up Default Value:** 1.00

**Note:** When entering a scale factor, the sign may be changed at any point in the key sequence using the (±) key.



**Smooth** The Smooth modifier stabilizes the least significant digits in the display for easier reading. This modifier causes the counter to keep a running average of least significant digits. This average is the rightmost digit displayed and will appear stable enough to read. Use of the Smooth modifier will increase resolution further.

**TURN ON SMOOTH** This procedure shows you how to turn on the Smooth modifier. The example shown below is valid for INPUT 1 CW, or pulse frequency measurements and works the same way for frequency measurements made through INPUT 2. The smooth modifier does not work for pulse envelope measurements (P WIDTH, OFFTIME, PRI, PRF, or PROFILE) or while in HOLD waiting for a triggered measurement.

Press: **SMOOTH**

(SMOOTH annunciator goes on)

**Effect:** Turns Smooth modifier ON or OFF. Input frequency/envelope parameter is averaged, and unstable digits in the display are masked with asterisks or with blanks, similar to Resolution display.

**Parameter Value Range:** Toggle function only.

**Note:** The number of masked digits in a Smooth display will vary continuously, depending on the stability of the source. Refer to the Resolution procedure for examples of the various possible Smooth displays.

## **EXTENDED FUNCTIONS AND HP-IB CONFIGURATION**

This subsection provides you with information for using extended functions and HP-IB configuration. The extended functions described are measurement or setup related. (Some of these functions may also be useful for troubleshooting.) Those extended functions that are primarily "diagnostic" are described in the next subsection "What To Do If There Is a Problem". The procedures for calling or changing an extended function (EFUN) are equally applicable to either measurement related or diagnostic extended functions. Brief procedures for displaying and changing the HP-IB address follow explanations of extended functions.

Each tutorial operating procedure shows the key (or key sequence, as necessary) to be pressed to perform the desired function, and the resultant display. A brief description of the effect of each function is given, and the allowable range for any parameter values are described, if applicable. The Power-up default conditions for each function are also given, with the term "Power-up" referring to connecting ac power to the instrument and then turning it on, as distinct from "Standby", which assumes that ac power is continuously connected.

### **Calling Extended Functions/Diagnostics**

Use the following procedures to turn on and call various extended functions for either measurement or troubleshooting tasks. When using extended functions, many different types of messages are possible. In the following paragraphs, only PASS messages are shown. Refer to Section 5 of the Service manual for descriptions of the various FAIL messages.

Most extended functions can be exited by pressing the EXTEND FUNCT key or the RESET/LOCAL key. However, certain diagnostics require special exit procedures, as described on page 2-60.

**TURN ON CURRENT  
EXTENDED FUNCTION**

This procedure shows you how to turn on the currently selected extended function. In the example below, extended function 04 is turned on while measuring a signal at INPUT 1, causing the counter to display its local oscillator frequency.

Press: **EXTEND FUNCT**

		GHZ		MHz		kHz		Hz		
Observe:		LO		350.0		MHz				FUNC 04

(display shows current LO value)

Effect: Turns current extended function ON or OFF.

Parameter Value Range: Toggle function.

Power-up Default Value: EFUN 1, OFF

Note: EFUN 98 (Keyboard Lockout), and Efun 99 (Display Lockout) cannot be re-entered by pressing the EXTEND FUNCT key. The extended function number is not retained by the counter after one of these functions has been exited; instead, the number automatically defaults to 1.

**SET A NEW EXTENDED  
FUNCTION NUMBER**

This procedure shows you how to select and turn on a new extended function. In the example below, extended function 01 (Self Check) is changed to 60 (IF Verification: 35 MHz; Disable INPUT 1 and IF) and then turned on.

Press: **SET/ENTER, EXTEND FUNCT**

		GHZ		MHz		kHz		Hz		
Observe:										1 FUNC

(display shows current value)

Press: **6, 0**

		GHZ		MHz		kHz		Hz		
Observe:										60 FUNC

(display shows new selection)

Press: **SET/ENTER**

	GHz	MHz	kHz	Hz	
Observe:	PASS	35	000	0**	A6 EF 60

(displays Pass or Fail message)

**Effect:** Sets extended function number and turns ON the extended function mode .

**Parameter Value Range:** 1 to 99. If an invalid extended function number is entered, the counter displays a "NOT AVAILABLE" message.

**MOVE TO NEXT  
EXTENDED FUNCTION**

This procedure shows you how to select the next extended function that is above or below the current one. In the example below, extended function 30 (MRC Channel A Verification; 10 MHz Timebase) is changed to 32 (Interpolator check).

Press: **SET/ENTER, EXTEND FUNCT, INC, INC, SET/ENTER**

	GHz	MHz	kHz	Hz	
Observe:	PASS		INTERPOL	A3	EF 32

(counter displays Pass or Fail message)

**Effect:** Sets extended function number to next higher or lower number, and proceeds to execute that function.

**Parameter Value Range:** 1 to 97. If the user increments or decrements to an invalid number, the counter displays a "NOT AVAILABLE" message until user has moved to a valid number. (Note that EFUN 98, and EFUN 99 cannot be enabled using the INC/DEC keys).

**SPECIAL  
EXTENDED FUNCTION  
EXIT PROCEDURES**

Most extended functions can be exited by pressing the EXTEND FUNCT key or the RESET/LOCAL key. Some extended functions require special exit procedures, as follows:

- a. To exit from a EFUN 1 failure, press the EXTEND FUNCT key; pressing the RESET/LOCAL key will only scroll through the test routines.

- b. To exit EFUN 51 (LO Synthesizer Verification - User-Entered Frequency) or EFUN 70 (Keyboard Test), press the RESET/LOCAL key; the EXTEND FUNCT, INCREMENT, and DECREMENT keys cannot be used to exit.
- c. The only way to exit EFUN 98 (Keyboard Lockout), and EFUN 99 (Display Lockout) is by entering a special key sequence (7, 4, 0, RESET/LOCAL), or by removing ac power to the instrument. After exiting EFUN 98 or 99, the extended function number defaults to 1.
- d. When pressing the special key sequence to exit EFUN 98 or 99, you should allow a short amount of time (about 1 to 2 seconds) to elapse between each key press. Pressing the keys too quickly prevents the counter from responding properly to each key in the sequence, causing the counter to remain in the extended function mode.

### Extended Function Descriptions

The following paragraphs describe what the Extended Functions do. General information is first, followed by specific descriptions. *Table 2- 5* lists all extended functions by access code number. There are forty-eight extended functions available for either measurement/setup related use or troubleshooting.

Table 2-5. Extended Functions and Codes

Code	Extended Function Name
1	*Self Check (Front Panel Only)
2	Display IF
3	Display MRC E & T Register Contents
4	Display LO (Synthesizer) Frequency
5	Display Harmonic Number (Integer) and Sideband
6	Display Harmonic Number (Fraction) and Sideband
7	Display Interpolator Short Calibration
8	Display Interpolator Long Calibration
9	Display Interpolator Measurement
10	*Timebase Verification
11	*Power Supply Verification
20	*Low Frequency 50 OHM Verification: 35 MHz
21	*Low Frequency 1 MOHM Verification: 35 MHz
30	*MRC Channel A Verification: 10 MHz Timebase
31	*MRC Channel B Verification: 10 MHz Timebase
32	*Interpolator Check
33	Display MRC E & T Register Contents for Pulse Measurements
34	Display Gate Bias Error
40	Display ROM Version Number
41	*RAM Test (Front Panel Only)
42	*ROM Test (Front Panel Only)
43	*Repeated Reset (Front Panel Only)
50	*LO Synthesizer Verification: 29.5 MHz and 35 MHz
51	LO Synthesizer Verification: User Entered Frequency
52	*LO Synthesizer Sweep
53	*LO Synthesizer Lower and Upper Frequency Bounds
54	Gate Bias Calibration
60	*IF Verification: 35 MHz; Disable INPUT 1 and IF
61	*Check Level Detector
62	Disable Hardware and Software IF Detector Flags: Display Measurements
63	Disable Hardware and Software IF Detector Flags: Display IF

Code	Extended Function Name
64	Disable Software IF Detector Flag: Display IF
65	*IF Verification: 35 MHz; Disable INPUT 1
66	Display IF Function Status Indicators
67	Disable IF Detector: Display IF Function Status Indicators
68	Display Narrow Pulse Harmonic Numbers
70	*Keyboard Test
71	*Display Test
72	Set Printer Option
73	(Reserved For Future Use)
80	*HP-IB Verification
81	Set Start Time for Profiling
82	Set Stop Time for Profiling
83	Set Fine Or Coarse Data for Profiling
84	Set Profiling Output Printer Options
85	Set Filter On/Off for Profiling Output
86	Enter ID Prefix for Profiling Printer Output Plot
87	Set Number of Data Points (Steps) for Frequency Profile
88	Set Start IF Cycle for Frequency Profile
89	Set Number of IF Cycles Per Step for Profiling
90	Set Gate Width in Time
91	Set Number of Averages for Frequency Measurement
92	Force Pulse or CW Measurement Mode
93	Enter <100ns Pulse Mode
94	High Resolution (INPUT 1 PRF/INPUT 2, 1 MOHM)
95	Set Gate Width by Number of IF Events or Cycles
96	Enter Chirp Mode
97	Set IF for Manual Center Frequency
98	Keyboard Lockout
99	Display Lockout
	Extended function titles preceded by an asterisk (*) are primarily diagnostic in nature and are explained in more detail in the next subsection.

When an extended function is activated, the counter continues to carry out a normal measurement cycle, but does not display the measured input frequency. Instead, each extended function causes the counter to display a particular measurement parameter used to compute the measured input frequency or allows you to customize a specific measurement factor such as gate width or LO frequency. The following paragraphs contain brief descriptions of extended functions. Unless otherwise noted, a given extended function displays a measurement parameter for either an INPUT 1 or INPUT 2 measurement.

The contents of each extended function display depend on the particular parameter involved. During any extended function display, a level condition, if present, is indicated by the letters "LVL" replacing a portion of the display. Refer to "What To Do If There Is a Problem" subsection at page 2-81 of this section for descriptions of all diagnostic extended functions.

**DISPLAY IF (EF 02)**

**Effect:** The counter displays the value of the IF, showing one digit greater than the chosen resolution (two digits for 1 Hz). The chosen resolution and sample rate affect the display, and also the Smooth function, if enabled. The IF is displayed only when the counter is set to INPUT 1; when set to INPUT 2, the counter displays the low frequency measurement. The IF display will be in the format shown below (assuming an IF of 75 MHz, and a chosen resolution of 1 Hz):

<i>IF</i>	<i>75</i>	<i>000</i>	<i>000</i>	<i>.nn</i>	<i>F 02</i>
<i>LVL</i>	<i>75</i>	<i>000</i>	<i>000</i>	<i>.nn</i>	<i>F 02</i>

**DISPLAY  
MRC E & T REGISTER  
CONTENTS (EF 03)**

**Effect:** The counter displays the contents of the MRC Events (E) and Time (T) registers, including overflow. The chosen resolution affects the contents of the Time register (gate time), but the selected sample rate does not affect register contents. Math functions, if enabled, also have no effect. The gate time equals the T register value multiplied by 100 ns. The T register portion of the display includes the fraction (in decimal form) calculated from the interpolator data.

For CW measurements, the E register contains the number of IF cycles (INPUT 1) or total zero crossings (INPUT 2). The T register contains the gate time during which the E events were counted. For pulse frequency measurements, the E register contains the number of averages set by the user or default

while the T register contains the total gate time of all averaged measurements. The messages are:

```
E 10019713 T 2003937 .28
E 10019713 T 2003 LVL
```

DISPLAY  
LO (SYNTHESIZER)  
FREQUENCY (EF 04)

Effect: Displays the current value of the LO frequency. In Auto mode, the LO value is displayed only when a measurement is in progress, not during signal acquisition or LO sweep. In Manual mode, the display of the LO value is stable. If the counter is switched to INPUT 2, the LO value will be 0.0. The messages are:

```
LO 350.0 MHz FUNC 04
LO 350.0 MHz LVL 04
```

DISPLAY  
HARMONIC NUMBER  
(INTEGER)  
AND SIDEBAND (EF 05)

Effect: Displays the value of the harmonic number (N), along with the sideband location of the input frequency (USB=upper sideband, LSB=lower sideband) with respect to N LO. If the instrument is in Auto or Manual mode, the display only changes when a new harmonic number has been determined. When INPUT 2 is active, the harmonic number is 0, and "USB" is displayed. The message display format is:

```
HARM 3 LSB FUNC 05
HARM 3 LSB LVL 05
```

DISPLAY  
HARMONIC NUMBER  
(FRACTION)  
AND SIDEBAND (EF 06)

Effect: Displays the value of the harmonic number (N) to .01 accuracy, along with the sideband information (refer to EFUN 5 description). When the counter is in Manual mode, the fractional value of N is 0. This auxiliary function can be used to see if FM on the input signal is affecting the measurement. The message display format is:

```
HARM 2.99 LSB FUNC 06
HARM 2.99 LSB LVL 06
```



DISPLAY  
INTERPOLATOR  
SHORT CALIBRATION  
(EF 07)

Effect: The Interpolator Start and Stop counts are displayed for the short MRC calibration mode. The Start and Stop values should be within  $\pm 20$  counts of each other, with a typical calibration count falling in the approximate range of 100-130. The Short calibration values should always be less than the values displayed by EFUN 8 (Interpolator Long Calibration). The message display format is:

```
SH CAL 126 125 FUNC 07
SH CAL 126 125 LVL 07
```

DISPLAY  
INTERPOLATOR  
LONG CALIBRATION  
(EF 08)

Effect: The interpolator Start and Stop counts are displayed for the long MRC calibration mode. The Start and Stop values should be within  $\pm 20$  counts of each other, with a typical calibration count falling in the approximate range of 290-310. The long calibration values should always be greater than the values displayed by EFUN 7 (Interpolator Short Calibration). The message display format is:

```
LONG CAL 308 307 FUNC 08
LONG CAL 308 307 LVL 08
```

DISPLAY  
INTERPOLATOR  
MEASUREMENT (EF 09)

Effect: The Interpolator Start and Stop counts are displayed for the current measurement. The Start value (the three digits to the left) should fall within the range of the Start values displayed by the Short Calibration (EFUN 7) and Long Calibration (EFUN 8) functions described above. Similarly, the Stop value (the three digits to the right) should fall within the range of the Stop values displayed by EFUN 7 and EFUN 8. The message display format is:

```
MEAS 245 218 FUNC 09
MEAS 245 218 LVL 09
```

DISPLAY  
MRC E & T REGISTER  
CONTENTS FOR PULSE  
MEASUREMENTS (EF 33)

Effect: The counter displays the contents of the MRC Events (E) and Time (T) registers for pulse measurements. Level is indicated if it occurs. The chosen resolution affects the contents of both registers, but the selected sample rate does not affect register contents. Math functions, if enabled, also have no effect. The T register portion of the display includes the fraction (in decimal form) calculated from the interpolator data. The contents of the E register is the number of events

counted during the time value contained in the T register. The messages are:

```
E 10019713 T 2003937 .28
E 10019713 T 2003 LVL
```

DISPLAY  
GATE BIAS ERROR (EF 34)

**Effect:** Displays the gate bias calibration error in picoseconds. The displayed value is the result of the gate bias calibration performed by extended function 54. The counter uses this number to adjust the gate times internally. The message format is:

```
GATE BIAS ERROR 104 PS
```

DISPLAY  
ROM VERSION NUMBER  
(EF 40)

**Effect:** Displays the ROM software version number currently in use in the instrument. The message display format is:

```
ROM VERSION 3847 A4 F 40
ROM VERSION 3847 LVL 40
```

LO SYNTHESIZER  
VERIFICATION:  
USER ENTERED  
FREQUENCY  
(EF 51)

**Effect:** lets you use the instrument as a down converter by selecting the sampler LO frequency. You are allowed to enter (via the front panel keys, or over the HP-IB) any frequency between 300 - 350 MHz. The LO will be set to the frequency entered. You can enter a new LO frequency any time. The down converted IF is available at the rear panel "IF OUT" connector.

You'll first need to determine where the LO must be set in order to generate the desired IF. The formula shown here lets you pick an IF output between 50 MHz - 100 MHz by setting the LO somewhere between 300 MHz - 350 MHz. Because the LO is quantized, some desired IF frequencies might not be obtained. The value of N (divisor) in the formula must be an integer between 1 and 67. (As high as 136 with Option 040.)

$$\frac{F(\text{in}) - \text{IF}}{N} = \text{LO}, \text{ Where: } \begin{array}{l} F(\text{in}) = \text{Frequency of signal at INPUT 1} \\ \text{IF} = 50 \text{ MHz} - 100 \text{ MHz} \\ \text{LO} = 300 \text{ MHz} - 350 \text{ MHz} \\ N = \text{Integer between 1 and 67} \end{array}$$

To illustrate the use of this formula, suppose we want to down-convert an input signal of 18.08 GHz to an IF of 80 MHz. First we subtract 0.08 from 18.08 GHz which leaves 18 GHz. We must now find the values of N (upper and lower within the permitted range of 1 - 67) that can provide an approximate 80 MHz IF with a LO between 300 - 350 MHz.

By dividing 18 GHz by the lower and upper LO frequencies, we can get an upper and lower harmonic N of 60 and 51 respectively. At this point, a trial and error process of selection can be used starting with the mid-point of the range to find the exact value that best approaches 80 MHz. The exact IF is computed by the following formula:

$$F(\text{in}) - (\text{LO} \times N) = \text{IF}$$

For a harmonic N of 55, the equation becomes,  $18.08 - (327.3 \text{ MHz})(55) = 78.5 \text{ MHz}$ . Although this is close to the desired IF, we can try another number in the range, for instance 60. For a harmonic N of 60, the equation is now,  $18.08 - (300 \text{ MHz})(60) = 80.0 \text{ MHz}$ . This gives us exactly 80 MHz.

When entering a value via the front panel keyboard, a four digit number (without the decimal point) must be entered, using the SET/ENTER key. For example, if the desired LO frequency is 310.5 MHz, enter 3, 1, 0, 5, SET/ENTER. The decimal point is displayed after the SET/ENTER key has been pressed.

To exit EFUN 51, press the RESET/LOCAL key, or use the DEC or INC key (arrow keys). The EXTEND FUNCT key cannot be used to exit EFUN 51 (the key is interpreted as a "1"). On entry to this function, the LO is automatically set to the last value used during the measurement cycle.

Indication of success or failure is shown on the display with an asterisk. The asterisk does NOT appear if the frequency is set and measured to be within the allowable margin defined by the upper and lower bounds of the synthesizer range. If the frequency is out of the synthesizer range, the asterisk appears on the display beside the requested frequency value. For example, if the LO is set to 295.9 MHz (within the allowable range), the messages would be:

```
ENTER LO 295.9 A5 F 51
ENTER LO 295.9 LVL 51
```

If you enter 4955 MHz (which is out of range), the message will be:

*ENTER LO 4955 \* A5 F 51*

The asterisk also appears if the instrument fails to measure the requested LO frequency.

**GATE BIAS CALIBRATION  
(EF 54)**

**Effect:** Performs Gate Bias Calibration. This function is always performed at power-up and can also be used to check the A14 Gating Assembly circuits. The results of this function can be displayed via extended function 34. The displayed message is:

*FUNCTION 54 CALIBRATING*

**DISABLE HARDWARE  
AND SOFTWARE  
IF DETECTOR FLAGS:  
DISPLAY MEASUREMENT  
(EF 62)**

**Effect:** Disables the IF inband detector, and assumes that the IF is always "good" (i.e. the proper IF range). After disabling the flag, the instrument returns to the normal measurement cycle for either frequency or envelope parameters and ignores the results of the IF 35 MHz - 105 MHz in-band test and also the software 45 MHz - 95 MHz check. The frequency is displayed as for a regular measurement, as shown:

*nn nnn nnn nnn FUNC 62  
nn nnn nnn nnn LVL 62*

If you call any other diagnostic (except for EFUN 63), or leave the diagnostic mode (by pressing RESET/LOCAL or toggling the EXTEND FUNCT key), the IF flags are once again enabled, and measurements proceed normally.

**DISABLE HARDWARE  
AND SOFTWARE  
IF DETECTOR FLAGS:  
DISPLAY IF (EF 63)**

**Effect:** Identical to EFUN 62, except that the instrument displays the IF, using the same format as EFUN 02 (Display IF). The messages are:

*IF nn nnn nnn .nn F 63  
LVL nn nnn nnn .nn F 63*

DISABLE SOFTWARE  
IF DETECTOR FLAG:  
DISPLAY IF (EF 64)

Effect: Similar to EFUN 62, but instead of disabling the IF inband detector, the software flag set by the IF frequency measurement (software check) is ignored; the IF is assumed to be always within the required range. The instrument returns to the normal measurement cycle and the current IF measurement is displayed as follows:

```
IF  nn  nnn  nnn  .nn  F  64
LVL nn  nnn  nnn  .nn  F  64
```

DISPLAY  
IF FUNCTION STATUS  
INDICATORS  
(EF 66)

Effect: Displays the status of the four IF function LED indicators on the A6 IF Assembly. An asterisk (\*) on the display indicates that a corresponding A6 LED is lit. The display is the same as the order of A6 LEDs from left to right: level, IF present, pulse mode, and IF inband latched. The message display format is:

```
IF STATUS **** A6 F 66
```

DISABLE IF DETECTOR:  
DISPLAY IF FUNCTION  
STATUS INDICATORS  
(EF 67)

Effect: Disables the IF detector and Displays the IF function status indicators in the same way as extended function 66 above. The message display format is:

```
IF STATUS **** A6 F 67
```

DISPLAY  
NARROW PULSE  
HARMONIC NUMBERS  
(EF 68)

Effect: Displays the harmonic numbers generated during measurement calculations for a 100 - 256ns pulse. (If option 040 is installed and Highband is active, then this pulse width range is 100 - 1024ns.) The harmonic numbers displayed are first, the initial estimate, followed by the actual number used for final measurement. This extended function also disables a tolerance check between the estimate and the actual number. This condition remains until some other extended function is called or SET/ENTER, RESET is pressed. The message display format is "n.nn" or "nn.nn" (decimal point implied):

```
HARM 000 U 000 U F 68
```

SET PRINTER OPTION  
(EF 72)

Effect: Lets you select which printer is to be used for the hardcopy profiling measurement output. When enabled, the following menu is displayed:

```
ENTER 0*TJET/QJET 1-PJET
```

The "\*" indicates the currently active option. To select ThinkJet or QuietJet, enter "0" (default) then press SET/ENTER. This selection is confirmed by the following message:

*THINKJET OR QUIETJET*

To select PaintJet, enter "1" then press SET/ENTER. This selection is confirmed by the following message:

*PAINTJET ONLY*

The default state occurs at power-up, after the HP-IB INIT command is used or after the SET/ENTER, RESET/LOCAL key sequence is entered.

**SET PRT OPT (EF 73)** Effect: Has no effect at present and is reserved for future printer support. When called, the following message is displayed:

*PRT OPT 0 F 73*

**SET START TIME FOR PROFILING (EF 81)** Effect: Sets the start time for profiling from 0 to 9.999999 ms. When selected EFUN 87, EFUN 88 and EFUN 89 are turned off, and the following prompt and message are displayed:

*0.000 T START*

To set a start time of 13ns, press the following keys: 1, 3, ns, SET/ENTER. This extended function operates together with EFUN 82 and EFUN 83 to specify how the profiling is to be done. The default value of 0 is loaded during power-up (full power-up or power-up from standby), after the INIT command, or after the SET/ENTER, RESET/LOCAL key sequence is entered.

**NOTE**

*Extended functions 81 and 82 require short-term signal stability of 70 kHz. If Errors occur while attempting use of these extended functions because of input signal instability, you can still use Efuncs 87, 88, and 89 to set up the measurement. Nominal IF period will be 14 ns.*

**SET STOP TIME FOR  
PROFILING (EF 82)**

**Effect:** Sets the stop time for profiling from 0 to 9.999999 ms. When selected, EFUN 87, EFUN 88, and EFUN 89 are turned off, and the following prompt and message are displayed:

*0.000 T FINAL*

To set a start time of 6 ms, press the following keys: 6, ms, SET/ENTER. The default value of 0 is loaded during power-up (full power-up or power-up from standby), after the INIT command, or after the SET/ENTER, RESET/LOCAL key sequence.

The default value of 0 uses the pulse width or the external gate width to determine the stop time, as long as ESTART (EFUN 87), EDELTA (88) and DATAPTS (89) are not being used to control the profile.

**SET FINE OR COARSE  
DATA FOR PROFILING  
(EF 83)**

**Effect:** Selects fine or coarse data for profiling. When selected, the following prompt and message are displayed:

*FINE DATA or COARSE DATA*

If FINE DATA is selected, approximately 50 data points are used for profiling. If COARSE DATA is selected approximately 10 data points are used. This extended function operates together with EFUN 81 and EFUN 82 to specify how the profiling is to be done.

The default value of FINE,ON is loaded during full power-up, after the INIT command or after the SET/ENTER, RESET/LOCAL key sequence. The fine or coarse profiling mode is stored in the standby RAM before power-down.

**SET PROFILING OUTPUT  
PRINTER OPTIONS (EF 84)**

**Effect:** Sets the profiling output printer options for tabular, graphic, or both. When selected, the following prompt and message are displayed :

*ENTER 0\* BOTH 1-PLT 2-TBL*

The "\*" indicates the currently active option. To select table only, enter "2", then press the SET/ENTER key. The following message appears after the selection:

*TABLE ONLY*

To select plot only, enter "1", then press the SET/ENTER key. The following message appears after the selection:

*PLOT ONLY*

To select both plot and table, enter "0", then press the SET/ENTER key. The following message appears after the selection:

*BOTH PLOT AND TABLE ON*

The default value, plot only, is loaded during full power-up, after the INIT command or after the SET/ENTER, RESET/LOCAL key sequence. The selection is stored in the standby RAM before power-off. Entering numbers other than 0, 1, and 2 will not change the current active mode.

When profiling, the message "PROFILING- -" is displayed. After the profiling is completed, the display changes to "PRINTING PLOT- -" during graphic output to the printer. The display changes to "PRINTING TABLE- -" during tabular output to the printer. When all the output to the printer is completed, the average frequency is displayed.

During Math overflow, the "MATH OVERFLOW" message is displayed at the end of profiling. The same message is also printed out on the text portion of the plot. These can be found alongside the rows for "Top of freq axis =", "Bottom of freq axis =" and "Average frequency =". The table output also has the same message printed out if there is a Math overflow error.



If you choose to manually control the profiling set-up parameters and then enter invalid values or parameter combinations, a plot error will occur. The counter will be unable to generate a plot and the message "PLOT ERROR" is printed out alongside the text legend of the plot. When this happens, the following parameters are set to 0 to indicate the error condition. In addition, the counter will display all 0's.

Time per division = 0 ns  
Freq per division = 0 Hz  
Start of time axis = 0 ns  
Stop of time axis = 0 ns  
Top of freq axis = 0 Hz  
Average frequency = 0 Hz  
Average step width = 0 ns

To obtain the printed output, ensure the counter's HP-IB address is set to 31 (TALK ONLY mode) and the printer is set to LISTEN ALWAYS mode. There must not be any other equipment connected to the HP-IB bus besides the printer and the counter (otherwise, the bus will hang). If the printer is not connected to the counter or set for the correct configuration, exit the profiling mode by cycling power to the counter.

During front panel operation, if you don't want to output data to the printer, then set the HP-IB address to values other than 31. At the conclusion of the profiling process, the average frequency is displayed.

**SET FILTER ON/OFF FOR  
PROFILING OUTPUT (EF 85)**

**Effect:** Toggles between filter on and filter off when selected. The following message is displayed when selected:

*FILTER ON (or) FILTER OFF*

The default value, filter on, is loaded during full power-up, after the INIT command or after the SET/ENTER, RESET/LOCAL key sequence. The filter state (on/off) is stored in the standby RAM before power-off. Refer to Appendix D, "Modifying the Measurement," for more information.)

ENTER ID PREFIX FOR  
PROFILING PRINTER  
OUTPUT PLOT (EF 86)

**Effect:** Permits entry of an identifying prefix no larger than six decimal digits for a specific printer output plot. When selected, the following prompt and message are displayed:

*ID PRFIX 0 F 86*

When this function is selected, the suffix for the ID is initialized to 0001. Input of leading zeros is not displayed but will be output to the printer. For example, to input Feb 8, 1990, press these keys: 0,2,0,8,9,0, SET/ENTER. The display shows 20890, but the output on the plot or the table will be 020890.0001 for the first hardcopy.

The default value of 000000 (the full ID default is 000000.0001) is loaded during power-up (full power-up or power-up from standby), after the INIT command or after the SET/ENTER, RESET/LOCAL key sequence.

SET NUMBER OF DATA  
POINTS (STEPS)  
FOR FREQUENCY PROFILE  
(EF 87)

**Effect:** Sets the number of steps during profiling. When selected, EFUN 81 and EFUN 82 are turned off and the following message and prompt is displayed:

*DATA PTS 0 F 87*

To set the number of steps to 35, press these keys: 3, 5, SET/ENTER. A maximum of 2 digits is allowed (the maximum number of steps is 99). This extended function operates together with EFUN 88 and EFUN 89 to specify how the profiling is to be done. The default value of 0 is loaded during power-up, after the INIT command, or after the SET/ENTER, RESET/LOCAL key sequence.

SET START IF CYCLE  
FOR FREQUENCY PROFILE  
(EF 88)

**Effect:** sets the start event for profiling between 0 and 999999. When selected, EFUN 81 and EFUN 82 are turned off and the following message and prompt is displayed:

*E START 0 F 88*

To set the start event to 213, press the following keys: 2, 1, 3, SET/ENTER. This extended function operates together with EFUN 87 and EFUN 89 to specify how the profiling is to be done. The default value of 0 is loaded during power-up, after the INIT command, or after the SET/ENTER, RESET/LOCAL key sequence.

**SET NUMBER OF IF  
CYCLES PER STEP FOR  
PROFILE (EF 89)**

**Effect:** sets the delta events for profiling between 0 and 999999. When selected, EFUN 81 and EFUN 82 are turned off and the following message and prompt is displayed:

*E DELTA 0 F 89*

To set the delta events to 34, press the following keys: 3, 4, SET/ENTER. This extended function operates together with EFUN 87 and EFUN 88 to specify how the profiling is to be done. The default value of 0 is loaded during power-up, after the INIT command, or after the SET/ENTER, RESET/LOCAL key sequence.

**SET GATE WIDTH  
IN TIME (EF 90)**

**Effect:** Lets you specify the gate width in time from 0 through 9.999999 msec. If the programmed gate width is longer than the measured pulse, then the counter will read 0 (actual width may vary due to presence of FM or chirp on pulse). When selected, the following prompt and message is displayed:

*0.000 ENTR GW*

Enter the desired gate time and press SET/ENTER. The counter resumes measurement using the new gate time and displays the resulting measurement. Entering 0 causes the counter to automatically determine the gate width. (See page D-5-7 for more details of gating.)

**SET NUMBER OF  
AVERAGES FOR  
FREQUENCY  
MEASUREMENT (EF 91)**

**Effect:** Lets you specify how many separate frequency measurements are averaged to yield a displayed value. The range of selectable values is 0 through 9,999. Selecting a value of 0 disables this extended function and causes the counter to automatically determine the number of averages necessary for a desired resolution. If the total accumulated gate time for a measurement exceeds 20 seconds, the counter may read a zero value. The total gate time equals the programmed gate width  $\times$  the number of averages. For externally gated measurements, if the total accumulated time exceeds 150 ms (external gate width  $\times$  number of averages), the counter may read 0. When selected, the following prompt and message are displayed:

*ENTER AV 0 A9 F 91*

Enter the desired average number and press SET/ENTER. The counter resumes measurement using the new average value and displays the resulting measurement. The RESOLUTION key now only controls the number of displayed digits.

**FORCE PULSE OR CW  
MEASUREMENT MODE  
(EF 92)**

**Effect:** Lets you override the counter's ability to automatically distinguish between pulse or CW signals. See Sample Rate Note for information about EFUN 92 use during HOLD, page 2-47. When enabled, the following menu is displayed with the asterisk indicating the currently active mode:

*ENTER 0-AUTO 1-CW 2\*PLS*

If you want the counter to measure only pulsed signals, enter "2", then SET/ENTER. The following message appears and the counter resumes measurement:

*PULSE MEASUREMENTS ONLY*

If you want the counter to measure only CW signals, enter "1", then SET/ENTER. The following message appears and the counter resumes measurement:

*CW MEASUREMENTS ONLY*

If you want to return to the automatic recognition of either pulse or CW signals, enter "0", then SET/ENTER. The following message appears and the counter resumes measurement:

*PULSE AND CW MEASURE*

**ENTER <100NS  
PULSE MODE (EF 93)**

**Effect:** Enables <100 nanosecond pulse mode after entering MANUAL mode. This extended function is necessary when you're measuring pulse bursts that are less than 100 nanoseconds wide. When first selected, this mode is turned ON and the following message is displayed momentarily:

*LESS THAN 100 NS MODE ON*

When selected a second time, this mode is turned OFF and the following message is displayed momentarily:

*LESS THAN 100 NS MODE OFF*

Any further selection of this function continues to toggle it on or off.

**HIGH RESOLUTION  
(INPUT 1,  
PRF/INPUT 2, 1 MΩ)  
(EF 94)**

**Effect:** Turns High Resolution ON. This extended function is useful when your measurements require resolution greater than 1 Hz. The function applies only to INPUT 1 pulse repetition frequency and INPUT 2, 1 MΩ frequency measurements. The higher resolution obtained using this function depends on the input frequency. Refer to *Table 2-4, High Resolution Displays* for detailed limits.

When first selected, this mode is turned ON and the following message is displayed momentarily:

*HIGH RESOL ON*

When selected a second time, this mode is turned OFF and the following message is displayed momentarily:

*HIGH RESOL OFF*

Any further selection of this function continues to toggle it on or off.

**SET GATE WIDTH  
BY EVENTS (EF 95)**

**Effect:** Lets you set the gate width by IF events or cycles from 0 through 999999. If the programmed gate width is longer than the measured pulse, then the counter will read 0. To allow the counter to determine the gate width automatically enter 0. When selected, the following prompt and message is displayed:

*ENTER GW 0 A9 F95*

Enter the desired gate width by events and press SET/ENTER. The counter resumes measurement using the new gate width and displays the resulting measurement.

**ENTER CHIRP MODE**  
(EF 96)      **Effect:** Causes the instrument to accommodate frequency chirp on the pulse by reducing the gate width. When first selected, this mode is turned ON and the following message is displayed momentarily:

*CHIRP MODE ON*

When selected a second time, this mode is turned OFF and the following message is displayed momentarily:

*CHIRP MODE OFF*

Any further selection of this function continues to toggle it or off.

**SET IF FOR MANUAL CENTER FREQUENCY**  
(EF 97)      **Effect:** allows you to specify the IF (in MHz) when setting a manual center frequency. When selected, software inband checks are disabled and the following prompt and message is displayed:

*ENTER IF 0 A9 F 97*

To set the IF to 56 MHz, press these keys: 5, 6, SET/ENTER. No more than 2 digits are allowed with a maximum IF of 99 MHz. Exit this Efun by entering 0 or pressing SET/ENTER, RESET.

**KEYBOARD LOCKOUT**  
(EF 98)      **Effect:** Causes the instrument to ignore all front panel keyboard entry, except for a special key sequence that exits the mode. The display continues to function normally. When the user enters this mode, a lockout message is shown for approximately 1 second; the counter then returns to its normal measurement display. The message is:

*KEY BOARD LOCK OUT*

**NOTE** 

---

*A level condition will NOT be indicated in the display.*

---

This function can only be entered using the standard extended function keyboard entry sequence (SET/ENTER, EXTEND FUNCT, 9, 8, SET/ENTER). The INC key advances to a maximum number of 97, and cannot be used to enter EFUN 98.

If a key is pressed at any time after the lockout is enabled, the lockout message appears briefly to indicate that the key has been ignored. The counter then returns to counting. If the instrument is powered-up from Standby with EFUN 98 active, the lockout message reappears for approximately 2 seconds. The counter then returns to counting. When the Keyboard Lockout is enabled and counting resumes, the extended function number defaults to 1.

The only way to exit EFUN 98 is to remove and then reconnect the ac power cord, send "INIT" over HP-IB, or to enter the following special key sequence: 7, 4, 0, RESET/LOCAL. Pressing this key sequence restores normal front panel control of the counter.

**DISPLAY LOCKOUT (EF 99)**

**Effect:** Locks out all messages from the display. All the annunciators are blank and the display shows the following constant message:

*DISPLAY LOCK OUT*

**NOTE:** \_\_\_\_\_

*A level condition will NOT be indicated in the display.*

---

This function can only be entered using the standard extended function keyboard entry sequence (SET/ENTER, EXTEND FUNCT, 9, 9, SET/ENTER). The INC key advances to a maximum number of 97, and cannot be used to enter EFUN 99.

If the instrument is powered-up from Standby with EFUN 99 active, the counter goes into normal measurement mode and displays the lockout message. When the Display Lockout is enabled and counting resumes, the diagnostic number defaults to 1.

The only way to exit EFUN 99 is to remove and then reconnect the ac power cord, send INIT" over HP-IB, or to enter the same key sequence used for exiting EFUN 98: 7, 4, 0, RESET/LOCAL. Pressing this key sequence causes the counter to return to normal message display.

### HP-IB Configuration

The following tutorial describes how to display, change, and determine the default values for the HP-IB address switch located on the rear panel of the counter. More detailed information about remote operation via HP-IB is located in Section 4 of this manual.

The power-up default value of the HP-IB address is:

HP-IB Address = HP-IB rear panel switch setting (A11S1)

#### NOTE

*The rear panel switch is read only after completion of all power-up Self Check/Cal routines. The HP-IB address is 00 until all power-up tests are completed and HP-IB initialization has occurred.*

### HOW TO DISPLAY THE HP-IB ADDRESS

This procedure describes how to identify the current HP-IB address. The example below displays the current HP-IB address of 14.

Press: **HP-IB Address**

		GHz		MHz		kHz		Hz	
Observe:								14	HP-IB

**Effect:** Displays current HP-IB address momentarily, then returns to measurement display.

**Parameter Value Range:** Display function.

**Note:** If the current instrument address is "31", the display is "TALK ONLY 31 HP-IB" (TALK annunciator on).



**HOW TO SET THE  
HP-IB ADDRESS:**

This procedure describes how to set a new HP-IB address. The example below shows the current HP-IB address of 14 being changed to 27.

**Press: Set/Enter, HP-IB Address, 2, 7**

		GHz		MHz		kHz		Hz		
Observe:								27		HP-IB

**Press: Set/Enter**

(New address entered, counter returns to measurement display)

**Effect:** Sets HP-IB address. This address is saved if the counter is switched to STBY. If ac power is removed from the instrument and then reapplied, the HP-IB address is determined by the switch settings of the rear panel HP-IB address switch (A11S1) after all power-up Self Checks are completed. No exit procedure is required for this mode, as the counter automatically returns to its previous status after the HP-IB address has been entered.

**Parameter Value Range:** 0 to 30 (31 = TALK ONLY)

**Note:** Be sure that the instrument address is not set to the same address as that of the controller. Typical HP controllers use address "21" as a preset address, thus the use of the address "21" as the HP 5361B address code should be avoided. In addition, when the HP-IB address is set to 31, the interface addresses itself to TALK, and will continuously handshake measurements over the bus. To escape the TALK ONLY mode, you must change the address and cycle the POWER switch.

**WHAT TO DO  
IF THERE IS  
A PROBLEM**

This subsection provides you with information for solving operating problems if they occur. If the problem can be fixed by the user a procedure or reference is given. The organization of this subsection is as follows: User Problems and Solutions, Power-on Tests, Keyboard Test, Failure and Error Messages, Overflow Warning, and Diagnostic Extended Functions.

**User Problems  
and Solutions**

The following list briefly describes some simple instrument problems and their solutions. This listing is not complete and

is meant to cover only some simple situations.

1. Nothing happens when you set the Power switch to ON.
  - a. Is the instrument plugged in to an ac power source?
  - b. If the instrument is connected to ac power, is the ac outlet live? (The red front panel STBY indicator should be lit when the instrument is OFF.)
  - c. If a and b are "Yes", is the Line Fuse blown or line voltage selection card set correctly? Refer to page B-2 if it is.
  - d. If you've replaced the Line Fuse and there's still a problem or the fuse blows again, set the Power switch to STBY and unplug the counter from ac power IMMEDIATELY. Refer service to qualified personnel or Hewlett-Packard Field Support.
2. Counter repeatedly fails one or more power-up Self Check subroutines and will not initialize.  
Refer service to qualified personnel or Hewlett-Packard Field Support.
3. You don't get the answer expected for measurements you've made.
  - a. Press SET/ENTER, RESET to preset the instrument and restore front panel setup values then try again.
  - b. Ensure that entered parameter values, conform to parameter range(s).
  - c. If input pulses are 100 ns or less, is extended function 93 active and manual mode ON with INPUT 1 active?
  - d. If input pulse repetition rate is <50 Hz, is the <50 Hz annunciator lit?
  - e. If the counter reads zero and you know that a chirped-pulse signal is present at INPUT 1, have you turned ON EFUN 96?
  - f. If the LVL message is displayed, verify the input power as 7 dBm or less, or wait for the IF AGC to settle.

4. Display shows "00 000 000 000" when you make CW measurements at INPUT 2.
  - a. Is either the 50 $\Omega$  or 1 M $\Omega$  measurement mode active?
  - b. Is the measurement source input to the counter active?
  - c. Is the INPUT 2 Low Frequency Input Fuse OK? If isn't, refer to page B-7 for replacement information.
  - d. You've replaced the fuse at INPUT 2 and the display still shows zero Hertz. Refer service to qualified personnel or Hewlett-Packard Field Support.
5. Display or Keyboard is locked-out.
  - a. Clear a display lockout via the keyboard, refer to page 2-79.
  - b. Clear a keyboard lockout via the HP-IB interface (refer to page 4-34, INIT command) or cycle ac power to the counter.
6. If you're having trouble with data entry refer to the "Entering Parameter Values" and "Data Entry Considerations" titles of "Using the HP 5361B" subsection at pages 2-20 and 2-21 of this section.
7. If you get the "MATH OVERFLOW" message, you'll need to change an offset or scale value that is causing overflow in the microprocessor's calculated results. (Reducing the measured frequency will also prevent math overflow.)
8. You're attempting to Auto Profile a pulsed or CW sweep signal without success.
  - a. Is the printer's HP-IB interface properly connected, addressed, and configured? (If you have a PaintJet, did you use EF 72 to configure the printer?)
  - b. If you initiated the Profile process to the printer and the keyboard locks-up, you MUST cycle power to the counter to recover. Before powering back up ensure that the printer is set to LISTEN ALWAYS mode (cycling power to the printer) and that it's the only other device connected to the HP-IB/GP-IB bus. Now, turn the counter ON and immediately check the HP-IB address: it must be 31; TALK ONLY.

- c. Did you set the counter's sample rate to HOLD before pressing the PROFILE key?
- d. Is the input signal repetitive?
- e. Is Chirp mode (EFUN 96) turned OFF?
- f. If no external Arm/Gate signal is routed to the counter, is the Gate mode set to Internal?
- g. If you're attempting to profile a swept CW signal, have you provided an external gate signal to commence the profile measurement process and set GATE mode to External?

### Power-On Tests

An automatic internal check (Power-Up Self Check) is made of several major components, including the microprocessor and related circuitry, when the counter is powered-up. During the power-up cycle, the display first shows all segments and annunciators lit, the "FUNC 54 CALIBRATING" message and then the current HP-IB address. At the same time, the instrument proceeds through a set of diagnostic routines to verify instrument operation, including both analog and digital circuit verification.

During Power-Up Self Check, the HP 5361B performs the following:

- a. A front panel display routine is performed, during which all LCD segments and annunciators are lit for about 3 seconds, allowing visual verification by the user.
- b. The microprocessor performs a RAM check, initializes the counter's measurement circuitry, initializes RAM, and then performs a ROM check.
- c. A Self Check sequence is performed which verifies proper operation of the timebase oscillator, the counting circuitry (including interpolators), the LO, Gating, and IF circuitry, and the low frequency input circuitry. Finally extended function 54 executes, performing the gate bias calibration of the gating circuits.
- d. The HP-IB interface is checked, and the address is read from the rear panel switch displayed. (If the counter is

powered-up from Standby, the last address entered via the front panel keyboard is recalled).

- e. The current instrument status is checked, and the front panel annunciators are restored accordingly. A check is made for the presence of an external reference and lockout conditions. The front panel annunciators are updated, if necessary.
- f. The Extended Function number is set to 1, Extended Function mode OFF, and the counter begins a measurement.

If any of the tests during the Power-Up Self Check fail, a failure message is displayed and remains until the RESET/LOCAL key is pressed, causing the next test to be executed (if possible). In this way, a failure may be bypassed to allow the counter to perform all of the power-up diagnostics.

To perform the Power-Up Self Check after the instrument has been turned on, cycle the POWER switch to STBY (Standby), then back to ON. During the Power-Up Self Check, all front panel LCD display segments and annunciators light momentarily, followed by the momentary display of the current HP-IB address. When all tests have been successfully completed, the counter measurement status is restored to conditions set before the POWER switch was cycled. (Note that the Power-Up Self Check is a more extensive test of the instrument than carried out when the front panel SELF CHECK key is pressed. Refer to the diagnostic extended function descriptions which follow.

If ac power was applied to the instrument just prior to turning it on, the counter will initialize itself to the following conditions when the POWER switch is set to ON:

- a. Measurement modes:
  - Auto (signal acquisition) – ON
  - Manual (signal acquisition) – OFF
  - Manual CF – 1 GHz
  - Low Frequency 50 $\Omega$  – OFF
  - Low Frequency 1M $\Omega$  – OFF
  - Low PRF Mode (Pulse Only) – OFF
  - <100 ns Pulse Mode (EFUN 93) – OFF
  - Chirp Mode (EFUN 96) – OFF

- b. Measurement functions:
  - Carrier Frequency                    - ON
  - Frequency Profile                   - OFF
  - Pulse Width                         - OFF
  - Pulse Offtime                       - OFF
  - Pulse Repetition Frequency       - OFF
  - Pulse Repetition Interval         - OFF
  
- c. Gate Mode - INTERNAL
  
- d. Measurement modifiers:
  - Sample Rate                         - FAST
  - Resolution                         - 1 MHz INPUT 1/  
1 Hz INPUT 2
  - Pulse Averaging                   - 1 (OFF)
  - FM Rate/Track                     - NORMAL (CW Only)
  - High Resolution                   - OFF
  
- e. Math functions:
  - Offset                               - OFF, 0
  - Scale                                - OFF, 1.000
  - Smooth                              - OFF
  
- f. HP-IB address                     - Rear panel switch setting
- Extended Functions                - OFF, 1

After the counter has initialized itself, the GATE INT, FM NORM (CW mode only), and AUTO annunciators are on, and the counter begins to count, if an input has been applied to INPUT 1. If no input has been applied to INPUT 1, the display shows all zeros, as follows:

GHz	MHz	kHz	Hz
00	000	000	000

### How to Use Self Check

If you want to run a test of the counter without cycling the ac power use the front panel SELF CHECK/CAL key. Use the procedure shown to check the instrument.

**Press: SELF CHECK/CAL**

**Observe: FUNCTION 54 CALIBRATING**

- then -

## PASS SELF CHECK

(displays Pass (or Fail) Message)

**Effect:** Turns ON Self Check/Cal routine. If Self Check passes, the pass message is displayed briefly, and then the counter returns automatically to its previous measurement mode. However, if Self Check fails, the RESET/LOCAL key must be pressed to by pass any failures and to exit the Self Check function. This key also executes extended function 54 which performs the gate bias calibration routine on the gating circuits.

**Parameter Value Range:** None

**Note:** The front panel Self Check/Cal function is a subset of the power-up Self Check routines. Such things as power supply, microprocessor, and RAM are not checked when this key is pressed. If self check fails, refer to page 2-88.

### Keyboard Check

Press the following key sequence:

**SET/ENTER, DIAGNOSTICS, 7,0, SET/ENTER**

to put the instrument in the Keyboard Check diagnostic mode (EFUN 70). The following message is displayed:

*KEY TEST*

*A7 F70*

In the Keyboard Check mode, pressing the front panel keys causes the display to change in response to the particular key being pressed. The new display remains until another key is pressed. For example, pressing the TRIGGER key causes the display to change to the following:

*KEY TRIGGER*

*A7 F70*

When performing the Keyboard Check, the keys may be pressed in any order, except the RESET/LOCAL key. You should press each of the keys and make sure that the associated message for each key is displayed, as listed below:

FREQ	OFFSET	RESOL	SELF CK	50 OHM
PW/OFFT	SCALE	GATE MD	HP-IB	1 MOHM
PRF/PRI	SMOOTH	FUNC	FM RATE	AUTO
RESET	SET	SAMP RT	TRIGGER	MANUAL

Pressing the RESET/LOCAL key causes the instrument to display "RESET" momentarily, and then exit from the test.

### Failure and Error Messages

A number of failure messages are possible during the Power-Up Self Check sequence. Almost all of the messages are in a form similar to the one shown below:

FAIL                    0\*\*    A2   F   20

In this example, EFUN 20 (Low Frequency Input, 50Ω Verification: 35 MHz) has failed, indicating a possible problem in the A2 Low Frequency Input Assembly.

If any test during the Power-Up sequence fails, the "FAIL" message remains until the user presses the RESET/LOCAL key. At that point, the next test is executed (if possible). By pressing the RESET/LOCAL key, most failures can be bypassed to allow the counter to proceed with the Power-Up check sequence. When the last test is complete, the counter proceeds to normal operation, if possible.

Refer to Section 3 of the Service manual or qualified service support, for troubleshooting information if a "FAIL" message appears during the Power-Up sequence.

Under certain conditions, the counter may display a message indicating that an internal error condition exists during normal instrument operation. These errors are detected by the counter and identified by one of the four numbered Error Messages listed in *Table 2-6*. Because these errors are user corrected, you should take the appropriate action to clear and prevent them from occurring again. The error message content explains what the problem is.



Table 2-6. HP 5361B Error Messages

ERROR 1:	HP-IB NOT IN	1 ERROR	Remedy by pressing the RESET/LOCAL key. Refer to HP SERVICE/SUPPORT Re-enter value within HP-IB command limits. Check/correct program command.
ERROR 2:	I/O	2 ERROR	
ERROR 3:	OUT OF RANGE	3 ERROR	
ERROR 4:	SYNTAX	4 ERROR	

**Overflow Warning**

If an entered offset or scale value combined with the input frequency causes an overflow in the microprocessor's calculated results, the counter will display:

**MATH OVERFLOW**

An "OVERFLOW" warning is cleared by removing the cause: changing the offset or scale value, or lowering the input frequency.

**Diagnostic  
Extended Functions**

You can selectively use the diagnostic extended functions to isolate problems within the HP 5361B. Use the procedures described beginning at page 2-58. to call up the functions described below.

The following paragraphs list and describe in numerical order those extended functions that perform internal instrument checks and verification. The full title of the function is shown with its function number followed by an explanation of what it can do.

**SELF CHECK (EF 1)**

**Effect:** Enables a particular sequence of diagnostic extended functions to test the measurement circuits of the counter. This function performs the same sequence of tests as the front panel Self Check function, but stays in a loop, repeating the test sequence until the extended function mode is exited or another function called. The tests are arranged so that each routine involves only one untested assembly. The test routines and the order in which they occur are listed in *Table 2-7*.

Table 2-7. EFUN 1 Self Check Sequence

EFUN Number	Test	Assembly
EFUN 11	Power Supply Verification	A1/A8
EFUN 10	Time Base Verification	A1
EFUN 30	MRC CH A Verification: 10 MHz Timebase	A3
EFUN 50	LO Verification: 29.5 MHz, 35.0 MHz	A5
EFUN 31	MRC CH B Verification: 35 MHz	A3
EFUN 60	IF Verification: 35 MHz, Disable INPUT 1 and IF	A6
EFUN 32	Interpolator Check	A3
EFUN 20	Low Frequency 50Ω Verification: 35 MHz	A2
EFUN 21	Low Frequency 1MΩ Verification: 35 MHz	A2
EFUN 54	Gate Bias Calibration	A14

**NOTE**

*EFUN 1 is not available over the HP-IB.*

If the counter passes EFUN 1, the messages are:

```
PASS 35 000 0** F 01
PASS 35 000 0** LVL 01
```

If a failure should occur, the counter displays the number of the failed EFUN, and the assembly involved. For example, if the EFUN 21 Direct Count test failed during EFUN 1, the display would be:

```
FAIL nn nnn nnn A2 F 01
```

The failure display formats for EFUN 11, 10, or 32 are exceptions to the format shown above. The possible messages are:

```
FAIL POWER A1 F 11
FAIL TIMEBASE A1 F 10
FAIL INTERPOL A3 F 32
```

If you exit the extended function mode during EFUN 1, the EFUN number remains at 1, regardless of whether the function passed or failed. For example, if the counter failed EFUN 31 during EFUN 1 and you exited the extended

function mode, the test number stored will be 1. The next time the EXTEND FUNCT key is pressed (to re-enter the extended function mode), the counter returns to EFUN 1, which (in this example) would again fail at EFUN 31.

**TIMEBASE VERIFICATION  
(EF 10)**

**Effect:** Confirms the presence of either an external or internal time base reference frequency. A signal (L 10MHz OK) from the Timebase Buffer circuit (on the A1 Timebase Buffer/Power Supply Control Assembly) is sampled by the A4 microprocessor to determine if the timebase is operational. The display messages are:

```
PASS TIMEBASE      A1 F 10
FAIL TIMEBASE      A1 F 10
PASS TIMEBASE      LVL  10
```

**POWER SUPPLY  
VERIFICATION (EF 11)**

**Effect:** Verifies operation of the power supply circuits on A1. The Power Supply circuit (on the A1 Timebase Buffer/Power Supply Control Assembly) sends a signal (H PWRSP OK) to the A4 microprocessor to indicate that most of the power supplies are functioning. All supply voltages in the instrument (except +5V, and the +3V on the A3 Assembly) are checked only for their presence or absence, but are not checked for specified voltage levels. The messages are:

```
PASS POWER         A1 F 11
FAIL POWER         A1 F 11
PASS POWER         LVL  11
```

**LOW FREQUENCY  
50Ω VERIFICATION:  
35 MHz (EF 20)**

**Effect:** Verifies the low frequency 50Ω measurement function. A 35 MHz test signal (AUX A/B) is provided by the A5 Synthesizer Assembly, derived by dividing the LO frequency (350 MHz) by 10. The A4 microprocessor switches this signal to the 50Ω input (INPUT 2) and the MRC counts the signal, verifying the frequency to ±100 Hz. This measurement is taken using a 100 ms gate time (with no interpolation). The messages are:

```
PASS 35      000  0**  A2 F 20
FAIL nn      nnn  nnn  A2 F 20
PASS 35      000  0**  LVL  20
```

**LOW FREQUENCY  
1 MΩ VERIFICATION:  
35 MHz (EF 21)**

**Effect:** Verifies the low frequency 1 MΩ measurement function. A 35 MHz test signal (AUX A/B) is provided by the A5 Synthesizer Assembly, derived by dividing the LO frequency (350 MHz) by 10. The A4 microprocessor switches this signal to the 1MΩ input (INPUT 2) and the MRC counts the signal, verifying the frequency to ±100 Hz. This measurement is taken using a 100 ms gate time (with no interpolation). The messages are:

```
PASS 35      000  0**  A2  F  21
FAIL nn      nnn  nnn  A2  F  21
PASS 35      000  0**  LVL  21
```

**MRC CHANNEL A  
VERIFICATION:  
10 MHz TIMEBASE (EF 30)**

**Effect:** Verifies MRC channel A. The microprocessor programs the MRC to count its own 10 MHz time base in both registers. The result is checked to ±100 Hz accuracy using a 100 ms gate time (with no interpolation). The messages are:

```
PASS 10      000  0**  A3  F  30
FAIL nn      nnn  nnn  A3  F  30
PASS 10      000  0**  LVL  30
```

**MRC CHANNEL B  
VERIFICATION:  
35 MHz (EF 31)**

**Effect:** Verifies MRC channel B. The 35 MHz test signal (AUX A/B) available from the A5 Synthesizer Assembly is used to test Input B of the MRC. The result is checked to ±100 Hz using a 100 ms gate time (with no interpolation). The messages are:

```
PASS 35      000  0**  A3  F  31
FAIL nn      nnn  nnn  A3  F  31
PASS 35      000  0**  LVL  31
```

**INTERPOLATOR CHECK  
(EF 32)**

**Effect:** Tests the interpolator circuitry by first comparing the Start and Stop measurements for the Short calibration. The difference must be less than 20 counts to pass the test. If the Short calibration values pass, the Long calibration is tested. The messages are:

```
PASS INTERPOL      A3  F  32
FAIL INTERPOL      A3  F  32
PASS INTERPOL      LVL  32
```

**RAM TEST (EF 41)** **Effect:** Performs a test algorithm on the microprocessor external RAM. The standby RAM inside the microprocessor is assumed to be functional, and is in use when performing the test. This test erases whatever is stored in the external RAM; critical values required to restore instrument operation after the test are saved in standby RAM. The messages are:

PASS RAM	A4 F 41
FAIL RAM	A4 F 41
PASS RAM	LVL 41

**NOTE:** EFUNs 41, 42, and 43 are not available via HP-IB.

**ROM TEST (EF 42)** **Effect:** Performs a checksum routine on the ROM. If the ROM which contains the execution code for this function is faulty, it is possible that the test may never be completed, causing an unpredictable display instead of a FAIL message. This depends entirely on the degree of the ROM failure. If the test passes or if the message display is not affected by a ROM failure, the possible messages are:

PASS ROM	A4 F 42
FAIL ROM	A4 F 42
PASS ROM	LVL 42

**REPEATED RESET (EF 43)** **Effect:** Performs a test sequence similar to the power-up self check. The sequence of tests for EFUN 43 is as follows:

1. Display: all segments lit, all annunciators lit.
2. Extended function 42: ROM Test.
3. Extended function 1: Self Test.
  - a. EFUN 11 – Power Supply Verification
  - b. EFUN 10 – Timebase Verification
  - c. EFUN 30 – MRC Channel A Verification: 10 MHz Timebase
  - d. EFUN 50 – LO Verification: 29.5 MHz, 35.0 MHz
  - e. EFUN 31 – MRC Channel B Verification: 35 MHz
  - f. EFUN 60 – IF Verification: 35 MHz; Disable INPUT 1 and IF



If the test passes both frequencies, the second AUX B measurement (LO/10 = 350/10) is displayed. The messages are:

```
PASS 35      000  0**  A5 F  50
FAIL nn      nnn  nnn  A5 F  50
PASS 35      000  0**  LVL   50
```

**LO SYNTHESIZER SWEEP  
(EF 52)**

**Effect:** Sweeps the synthesizer from 275.0 MHz up to 375.0 MHz, in 100 kHz steps. EFUN 52 does not show a pass or fail message on the display, but instead gives a message indicating that a test is in progress. The complete sweep requires about four seconds. The results of this test may be seen by connecting a spectrum analyzer to the W2 output cable of the A5 Synthesizer Assembly. The messages are:

```
275-375      LO SWEEP  A5 F  52
275-375      LO SWEEP  LVL   52
```

**LO SYNTHESIZER LOWER,  
UPPER FREQUENCY  
BOUNDS (EF 53)**

**Effect:** Determines the upper and lower bounds of the LO frequency. The A4 microprocessor attempts to program the synthesizer well below its known lower bound range. The measured frequency is a very good approximation to the lower bound. A similar procedure determines the upper bound. These upper and lower values are displayed for visual verification by the operator (the A4 microprocessor does not make a pass/fail decision). The messages are:

```
LO  nnnn  HI  nnnn A5 F  53
LO  nnnn  HI  nnnn LVL   53
```

– where nnnn represents some Local Oscillator frequency in the format nnn.n MHz (the decimal point is implied). For example, if “LO 2505 HI 3985” is displayed, the lower bound is 250.5 MHz, and the upper bound is 398.5 MHz.

The lower bound of the LO frequency should be less than 275 MHz (a typical value would be 245 MHz). The upper bound should be greater than 375 MHz (a typical value would be 405 MHz).

**IF VERIFICATION: 35 MHz;  
DISABLE INPUT 1 AND IF  
(EF 60)**

**Effect:** Verifies A6 IF function. The 35 MHz test signal (AUX A/B) provided by the A5 Synthesizer Assembly is switched to the A6 IF Amplifier/Detector Assembly which in turn sends the signal to Channel A of the MRC to be counted. The signal

is counted to  $\pm 100$  Hz accuracy using a 100 ms gate time (with no interpolation). To ensure proper diagnostic results, the microprocessor disables the INPUT 1 circuit by turning off dc power to the A12 Microwave Assembly, and disables the normal IF path by turning off the first two gain stages of the A6 Assembly. The messages are:

```
PASS 35      000  0**  A6 F  60
FAIL nn      nnn  nnn  A6 F  60
PASS 35      000  0**  LVL   60
```

**CHECK LEVEL DETECTOR**  
(EF 61)

**Effect:** Indicates whether the level detector has triggered and been detected by the A4 microprocessor during the time since the last reset of the level flag. (A red LED at the top of the A6 IF Amplifier/Detector Assembly indicates the circuit level status.) There are two possible ways that the level flag can be reset: pressing the RESET/LOCAL key to exit this function, or switching the instrument power off (STBY). If this test is exited using the EXTEND FUNCT key, the flag is NOT reset. The messages are:

```
NO LVL OCCURRED      A6 F  61
LVL OCCURRED         A6 F  61
```

**IF VERIFICATION: 35 MHz;**  
**DISABLE INPUT 1 (EF 65)**

**Effect:** Similar to EFUN 60. The AUX A/B 35 MHz test signal from the A5 Synthesizer Assembly is switched by the A4 microprocessor to the A6 IF Amplifier/Detector Assembly, which in turn sends the signal to Channel A of the MRC to be counted. The signal is counted to  $\pm 100$  Hz accuracy using a 100 ms gate time (with no interpolation). To perform this test, the microprocessor disables the INPUT 1 circuit by turning off dc power to the A12 Microwave Assembly, in the same way as EFUN 60; however, the normal IF path is NOT disabled. The messages are:

```
PASS 35      000  0**  A6 F  65
FAIL nn      nnn  nnn  A6 F  65
PASS 35      000  0**  LVL   65
```



**KEYBOARD TEST (EF 70)** Effect: Allows the front panel keyboard to be tested. Any key, when pressed, causes the name of the key function to be displayed. The displayed key names are:

FREQ	OFFSET	RESOL	SELF CK	50 OHM
PW/OFFT	SCALE	GATE MD	HP-IB	1 MOHM
PRF/PRI	SMOOTH	FUNC	FM RATE	AUTO
RESET	SET	SAMP RT	TRIGGER	MANUAL

Before a key is pressed, the messages are:

KEY TEST	A7 F 70
KEY TEST	LVL 70

When a key is pressed, the display changes to show the function name of the pressed key. For example, if the user presses the MANUAL key, the message will be:

KEY MANUAL	A7 F 70
------------	---------

To exit this routine, you must press the RESET/LOCAL key. The word RESET appears on the display for approximately 1 second, and then the instrument returns to the normal measurement mode. Pressing the EXTEND FUNCT key will NOT exit this test, as it is interpreted as a key to be tested, and only displays the test message associated with that key. (Note that the INC and DEC functions are also not usable, as pressing either one is interpreted as a test of the SCALE and SMOOTH function keys.)

**DISPLAY TEST (EF 71)** Effect: Causes the display to alternate between fully lit (all segments and annunciators) and fully blank (no segments and no annunciators lit). A visual verification is required. A level indication will NOT be shown in this display.

**HP-IB VERIFICATION (EF 80)** Effect: Causes the A11 HP-IB Interface Assembly to execute its start-up tests, resetting the HP-IB processor and initializing its memory. The messages are:

PASS HP-IB	A11 F 80
FAIL HP-IB	A11 F 80
PASS HP-IB 000 0**	LVL 80

**NOTE**

EFUN 80 is not available over the HP-IB.



## HP 5361B CONTROLS AND INDICATORS

---

### SECTION GUIDE

This section provides you with information about the HP 5361B controls, indicators, and signal connections. The front panel keys, display, and signal connections are explained first followed by the rear panel features. A large foldout illustration (*Figures 3-2 and 3-3*) is provided as an aid to locate and understand the front and rear panel features of the HP 5361B.

### Where to Find Important Topics

- Ac Power Input Module pg. 3-21
- Front Panel Connectors pg. 3-19
- Front Panel Display and Annunciators pg. 3-13
- Gate/Arm input pg. 3-20
- Key Functions pg. 3-3
- HP-IB Address Switch pg. 3-22
- HP-IB Connector pg. 3-22
- SCOPE-VIEW Output pg. 3-19
- Rear Panel Connectors pg. 3-22, 3-23

### Section Summary

- Front Panel Features pg. 3-2
- Rear Panel Features pg. 3-21

## FRONT PANEL FEATURES

Figure 3-2 shows you the front panel features of the HP 5361B. The following paragraphs provide descriptions of these features. Complete explanations of all keys and functions follow a general description of the keyboard layout and organization. A detailed description of the front panel display and annunciators begins after the key function descriptions. This is followed by a description of the front panel connectors.

### Keyboard

The front panel keyboard contains 20 push- buttons that send data and commands to the microprocessor. You can use the keyboard to select functions, control measurements, and enter data. The keyboard switches consist of a RESET/LOCAL key, a SET/ENTER key, three FUNCTION keys, three MATH keys, and twelve CONTROL/DATA keys, as shown in Figure 3-2.

All keys on the keyboard, except SET/ENTER, play multiple roles of function selection and parameter (data) entry. Function selection assignments are labeled above each key on the front panel. Data entry assignments are labeled either to the left of each key or directly on the face of each key cap. Refer to Table 3-1 for a summary of all key assignments.

Table 3-1. Key Assignments

FUNCTION ASSIGNMENT	DATA ENTRY ASSIGNMENT
AUTOMATIC	3
MANUAL	±
50Ω	9
1MΩ	6
RESOLUTION	7
EXTENDED FUNCTION	1
FM RATE/TRACK	2
SAMPLE RATE	0
HP-IB ADDRESS	5
GATE MODE	4
SELF CHECK/CAL	8
TRIGGER	.
OFFSET	LST VAL (last value)
SCALE	→ INC (increment)
SMOOTH	← DEC (decrement)
FREQUENCY/PROFILE	GHz ms
P WIDTH/OFFTIME	MHz μs
PRF/PRI (1/PRF)	kHz ns

After you press the SET/ENTER key and select a function such as offset, the display prompts you for more information. The keyboard now becomes a numeric data entry pad. Enter the requested data and end by pressing the SET/ENTER key a second time. In the OFFSET mode, entry of the last measurement value as an offset is simplified by the LST VAL key; this function sets the offset as the negative value of the last measurement. The LST VAL key can also be used to set the manual center frequency to the last measurement and enter offset values for pulse parameter measurements.

## Key Functions

The following paragraphs explain the basic function of each key on the front keyboard. Three of the keys, FREQUENCY/PROFILE, P WIDTH/OFFTIME, and PRF/PRI (1/PRF), are grouped together in the FUNCTION group. Three more, OFFSET, SCALE, and SMOOTH, are in the MATH section. The remaining keys, except for RESET/LOCAL and SET/ENTER, are grouped together in the CONTROL/DATA section. The location of each key is shown in *Figure 3-2*. Refer to Section 2, "Further Use of the HP 5361B", for examples of how to use each of the major functional modes of the HP 5361B.

## POWER

When the POWER switch is in the ON position, power is applied to the instrument. The STBY (Standby) position removes operating power to the instrument, but provides power for certain microprocessor and timebase circuits. When present, the Option 001 or 010 oven oscillator also receives power to maintain a constant temperature for the crystal.

The STBY LED indicator located to the left of the POWER switch remains on when the switch is in the standby position. The input to the power transformer, and dc voltages to the microprocessor standby RAM, timebase buffer, and the oscillator oven circuitry are always energized whenever power is connected, regardless of front panel power switch setting.

## WARNING

---

BEFORE APPLYING AC POWER, THE INSTRUMENT AND ALL PROTECTIVE EARTH TERMINALS, EXTENSION CORDS, AUTO-TRANSFORMERS, AND DEVICES CONNECTED TO THE INSTRUMENT SHOULD BE CONNECTED TO A PROTECTIVE EARTH GROUNDED SOCKET. ANY INTERRUPTION OF THE PROTECTIVE EARTH GROUNDING WILL CAUSE A POTENTIAL SHOCK HAZARD THAT COULD RESULT IN PERSONAL INJURY.

---

The rear panel reference outputs are available when in standby mode, and the state of the instrument is saved as long as ac power is connected to the instrument. All parameter and function settings are stored in the processor standby RAM.

### RESET/LOCAL

You can press this key to abort any current activity and resume measuring if the counter is already in the measurement mode. Pressing RESET/LOCAL clears any Error messages, which may appear, and exits the Self Check/Cal or Extended function modes. If you are entering data via the front panel keyboard, pressing RESET/LOCAL aborts any partially entered sequence, and the counter returns to the current measurement mode. If the counter is in the extended function mode, RESET/LOCAL aborts any partially entered sequence, and the counter returns to the current measurement mode.

If the instrument is in the remote operating mode, then the RESET/LOCAL key also acts as a "return to Local" key. It is the only active key when the counter is in the remote mode, and may be disabled using the "Local Lockout" HP-IB function, or the "Keyboard Lockout" function (EFUN 98).

You can initialize the counter to the same state as plug-in power-up without erasing the HP-IB address by first pressing SET/ENTER, and then RESET/LOCAL.

### FREQUENCY/PROFILE

Press this key to display the carrier frequency of a microwave pulse/CW input or begin profiling a microwave pulse or CW sweep signal. The default power-on state for this function pair is FREQUENCY. The two functions, frequency and profile, toggle with successive keystrokes.

Pressing the PROFILE key causes the counter to “frequency” profile a repetitive pulse or CW sweep signal. The frequency profile feature of the HP 5361B is illustrated in the “Auto Pulse Profiling” application example beginning on page 1-16 of Section 1 in this manual. Refer to page 2-31 for more information concerning the PROFILE key function and Appendix D for details of how this measurement function can operate and be customized with extended functions 81 through 89.

After you have pressed this key the display momentarily shows “FREQUENCY MEASUREMENT” or “PROFILE MEASUREMENT” followed by the actual measurement value. The counter continues to measure and display frequency values until you select another pulse measurement function, measurement mode, math modifier, or measurement modifier. There is no data entry associated with the FREQUENCY function. Refer to page 2-30 in Section 2 for information on how to use the FREQUENCY key function

#### **P WIDTH/OFFTIME**

Press this key to view either the width (duration) of a pulse or the interval of time between the end of one pulse and start of the next pulse. When you first press this key, the display momentarily shows “PULSE WIDTH” followed by the actual measurement value. This value is displayed until you press the key a second time or select another pulse parameter, measurement mode, math modifier, or measurement modifier. This key does not work if INPUT 2 is selected.

When pressed a second time, the display momentarily shows “PULSE OFF TIME” followed by the actual value of the measurement. When you press this key repeatedly, the measurement function toggles between P WIDTH and OFFTIME. There is no data entry associated with this key. Refer to page 2-33/34 in Section 2 for information on how to use the P WIDTH/OFFTIME key.

#### **PRF/PRI (1/PRF)**

Press this key to view either the Pulse Repetition Frequency (PRF) of a pulse or its Pulse Repetition Interval (PRI). When you first press this key, the display momentarily shows “PULSE REP FREQ” followed by the actual measurement value. This value is displayed until you press the key a second time or select another pulse parameter, measurement mode, math modifier, or measurement modifier. This key does not work if INPUT 2 is selected.

When pressed a second time, the display momentarily shows "PULSE REP INTERVAL" followed by the actual value of the measurement. When you press this key repeatedly, the measurement function toggles between PRF and PRI. There is no data entry associated with this key. Refer to page 2-34/35 in Section 2 for information on how to use the PRF/PRI (1/PRF) key.

**OFFSET** This key allows you to enter a positive or negative constant automatically added to each measurement. When you press the OFFSET key, the current offset value is displayed until the key is released, after which the counter continues measuring, displaying the sum of the input value plus the offset. A negative offset is displayed with a minus sign immediately to the left of the digits.

A blank space is displayed to the left of the digits for a positive offset. You can change the sign at any time during parameter entry, toggling it as many times as you wish. The offset is entered in megahertz, down to 1 Hz resolution for frequency measurements and milliseconds (ms), microseconds ( $\mu$ s), and nanoseconds (ns) for pulse envelope measurements. After the decimal point is pressed, subsequent digits are displayed to the right of the 1 MHz position in the parameter section. The final, entered offset is displayed with no decimal point, as it is fixed-point notation. To turn off the offset, press the OFFSET key again.

The offset value may be entered using the Control/Data keys or by pressing the LST VAL (Last value) key. When using the LST VAL key, the offset is set to the negated value of the last CW frequency/pulse parameter measured, exclusive of any math function that may be active. Refer to page 2-51 in Section 2 for information on how to use the OFFSET key.

**SCALE** Press this key to enter a signed constant, used as a multiplication factor. (Entering a decimal fraction lets you effectively perform division.) Pressing the SCALE key turns on the Scale function, and the current scale value is displayed until the key is released. After the key is released, the counter continues measurement and display of the scale factor/measurement product. When combined with the Offset function, the counter automatically computes and displays the following:

$$[(\text{Measurement value}) \times (\text{SCALE})] + \text{OFFSET}$$



To turn off the Scale function, press the SCALE key again. Refer to page 2-55 in Section 2 for information on how to use the SCALE key.

**SMOOTH** Pressing the SMOOTH key lets you initiate the "automatic resolution" algorithm, causing the counter to display only those digits that are stable. The input CW frequency/pulse carrier frequency is averaged to remove small deviations and stabilize the display. The unstable digits are masked in the same manner as the RESOLUTION display. Pressing the SMOOTH key a second time disables the Smooth function. There is no data entry associated with this function. Refer to page 2-57 in Section 2 for information on how to use the SMOOTH key.

**SET/ENTER** You'll need to use this key during parameter value entry for various keyboard functions. Parameter value entry is always initiated by pressing the SET/ENTER key once, after which the counter displays "SET". The counter then waits for you to press a function key. After a function key has been pressed, the keyboard is in "parameter entry mode" and the "0-9" keys are available (Refer to *Table 3-1*). Parameter entry is terminated by pressing the SET/ENTER key a second time (entering the value into memory).

When setting a parameter value, you can abort the entire sequence at any time by pressing the RESET/LOCAL key. The counter will then return to the state it was in before the SET/ENTER key was pressed. Refer to page 2-20 in Section 2 for information on how to use the SET/ENTER key.

**RESOLUTION** This key allows you to change the number of significant digits displayed for measurements. For CW measurements, a higher resolution results in a longer gate time; the lower the resolution, a shorter gate time. You can vary this parameter in decade steps from 1 Hz (highest resolution) to 1 MHz (lowest resolution) using the INC (increment) and DEC (decrement) keys. Since the minimum gate time is 1 millisecond, resolutions of less than 1 kHz change only the displayed resolution, not the measurement time.

During pulse measurements, resolution and gate time are not related as simply as for CW measurements. A higher requested resolution requires measurement of an increased number of pulses. The number of pulses required to obtain a given resolution is a function of both the resolution requested

and the width of the pulse. The number of pulses averaged increases as the pulse width decreases for a given resolution. If a requested pulse resolution cannot be obtained, then an asterisk is shown at the right side of the display along with the requested digit.

The current setting of the frequency resolution/pulse averaging may be displayed by pressing the RESOLUTION key during measurements. The displayed value remains until the key is released.

For frequency resolution, the nonsignificant digits of a measurement are rounded off and shown either blanked or replaced by the asterisk symbol \*, depending on the resolution. Refer to page 2-42 in Section 2 for information on how to use the RESOLUTION key.

For pulse averaging, the current number of averages is displayed momentarily. Refer to page 2-45 in Section 2 for information on how to use the Averaging function.

#### **GATE MODE**

This key lets you select the gate mode best suited for your measurement needs. Pressing this key cycles through three gate modes: Arm, External, and Internal. Both CW and Pulse measurements are automatically gated when the counter is set to Internal gate mode (Sample Rate not set to HOLD).

If either Arm or External gate are selected, an external signal must be provided at the front panel GATE/ARM input. Refer to page 2-37 of Section 2 for more information on how to use gating and arming during pulse/CW measurements.

#### **EXTENDED FUNCTION**

This key allows you to call up extended function routines that can provide additional measurement information or perform various tests on the instrument for troubleshooting. Pressing this key once turns on the extended functions and causes the counter to carry out the current extended function routine. The current routine is the one last entered, or if the counter has just been turned on, the default of 1. To exit this mode, press the EXTENDED FUNCTION key a second time, or press the RESET/LOCAL key.

You may enter a new extended function number (from 1 to 99) in the parameter entry mode, by using the Control/Data keys for numeric entry. Most of the functions may also be entered using the INC (increment) or DEC (decrement) keys. Other

instrument functions may be set up while in extended function mode (for example, measurement modes, resolution, etc).

You can call 20 different diagnostic extended function routines for testing instrument circuitry. Not all of the numbers between 1 and 99 are used for extended functions. If you enter an invalid number the counter shows a "NOT AVAILABLE FUNC nn" message on the display. (See *Table 2-5*, page 2-62.)

To get out of a "NOT AVAILABLE FUNC nn" condition, use the INC or DEC keys to go to the nearest valid choice, or use the SET/ENTER key sequence to enter a new selection. The Extended function mode may also be exited as described previously, using the EXTENDED FUNCTION or RESET/LOCAL key. Refer to page 2-58 in Section 2 for information on how to use the EXTENDED FUNCTION key.

#### **SAMPLE RATE**

This key lets you set the dead time between measurements. The maximum rate (Fast) allows the instrument to count as frequently as possible. The other extreme (Hold) keeps the last measurement until you start a new measurement by pressing the TRIGGER key. When the sample rate is set at "Hold", the HOLD annunciator is lit.

While setting the sample rate, the GATE annunciator flashes at the currently selected rate. Pressing the SAMPLE RATE key while the instrument is counting causes the current sample rate to appear until the key is released, after which the counter returns to counting. Refer to page 2-47 in Section 2 for information on how to use the SAMPLE RATE key.

#### **HP-IB ADDRESS**

This key lets you display and set the HP-IB address. When you power-up the instrument just after restoring ac power, the HP-IB address of the counter is determined by the rear panel address switch. (Switch settings on the HP-IB board.) Pressing the HP-IB ADDRESS key displays the current address until the key is released, after which the instrument resumes counting. The current address can be changed by going to the parameter entry mode and using the SET/ENTER key. Addresses 0 through 30 are valid bus addresses. Address 31 is used to set the counter to the TALK ONLY mode.

If the counter is switched to STBY and then back to ON, it remains set to the HP-IB address entered via the front panel keyboard. If ac power to the instrument is lost and then restored, the instrument defaults to the address determined by

the rear panel address switch settings. Refer to page 2-80 in Section 2 for information on how to use the HP-IB ADDRESS key.

#### **SELF CHECK/CAL**

You can press the SELF CHECK/CAL key to do a quick operational verification of the instrument. Self Check calls up a sequence of diagnostic subroutines that test the measurement circuitry. The subroutines are ordered so that no test depends on more than one untested circuit assembly. A Gate Bias calibration is also performed.

If Self Check passes, a "PASS" message is displayed for about 3 seconds, and the counter returns to the measurement cycle. If Self Check fails, a "FAIL" message is displayed. After a failure, the Self Check sequence restarts and the failure message continues to appear.

You can bypass Self Check failures by pressing the RESET/LOCAL key. The remaining subroutines in the Self Check sequence will be carried out, until another failure occurs, or the last test is completed. Pressing the RESET/LOCAL key again returns the counter to its previous measurement mode. Refer to page 2-86 in Section 2 for information on how to use the SELF CHECK/CAL key.

#### **FM RATE/TRACK**

The FM RATE/TRACK key works only when using INPUT 1 and AUTO mode for CW measurements. You can use this key to select three different acquisition methods during high frequency CW measurements. These options let you improve signal tracking or compensate for very low FM rates.

Pressing the FM RATE/TRACK key toggles this function through its states: Normal Rate, Low Rate, and Track. When set to Low Rate, the measurement gate time of the counter is increased to ensure an accurate measurement of signals with FM rates as low as 45 Hz, and high deviation. When set to Track, a faster acquisition time is used to improve signal tracking of frequencies with FM rates equal to or greater than 300 kHz, and high deviation.

One of three front panel annunciators (FM NORM, LOW, TRACK) is lit to indicate which FM Rate/Track mode is currently selected while in Auto mode. When the instrument is in Pulse mode, none of these annunciators are lit. There is no data entry associated with this function. Refer to page 2-49 in

Section 2 for information on how to use the FM RATE/TRACK key.

**TRIGGER** Press the TRIGGER key to start a new measurement when the counter sample rate is set to HOLD. There is no data entry associated with this function. Refer to page 2-49 in Section 2 for information on how to use the TRIGGER key. Pressing this key when the counter is not in "HOLD" will abort the current measurement and restart another.

**50Ω** You can use this key to select the Low Frequency, 50Ω input mode (INPUT 2) for measuring CW signals between 10 MHz to 525 MHz from 50Ω sources. Pressing the 50Ω key turns on this mode, and disables the INPUT 1 high frequency circuit by turning off the A12 Microwave Assembly. The measured frequency is displayed in the parameter section of the display; the message section shows "CW IN2".

To exit the 50Ω mode, press one of the three other measurement mode keys (AUTO, MANUAL, 1MΩ); pressing the 50Ω key a second time has no effect. There is no data entry associated with this key. Refer to page 2-27 in Section 2 for information on how to use the 50Ω key.

**1MΩ** You can use this key to select the Low Frequency, 1MΩ input mode (INPUT 2) for measuring CW signals between 10 Hz to 80 MHz from 1MΩ sources. Pressing the 1MΩ key turns on this mode, and disables the INPUT 1 high frequency circuit by turning off the A12 Microwave Assembly. The measured frequency is displayed in the parameter section of the display; the message shows "CW IN2".

To exit the 1MΩ mode press one of the other measurement mode keys; pressing the 1MΩ key again has no effect. There is no data entry associated with this key. Refer to page 2-27 in Section 2 for information on how to use the 1MΩ key.

**AUTO** Press this key to put the counter in the Automatic measurement mode. The instrument powers-up in the automatic measurement mode, and the AUTO annunciator on the front panel is lit. In this mode, the counter automatically acquires and measures the signal at INPUT 1.

Measurements are displayed in the parameter section of the display; the message section of the display shows the current measurement mode, or displays "LEVEL" if a level condition

exists. To exit the Auto mode, press one of the other measurement mode keys; pressing the AUTO key a second time has no effect. There is no data entry associated with this key. Refer to page 2-23 in Section 2 for information on how to use the AUTO key.

**MANUAL** This key lets you enter a specific Center Frequency (CF) for the counter to measure. To enter this mode, press the MANUAL key. The most recent measurement becomes the Manual CF. The CF is displayed until the key is released, then the counter begins counting in Manual mode.

The measured frequency is shown in the parameter section of the display; the message section shows the current measurement mode or displays "LEVEL" if a level condition exists. To exit the MANUAL mode, press The AUTO, 50  $\Omega$ , or 1 M $\Omega$  key; pressing the MANUAL key a second time has no effect.

Enter a center frequency by pressing the SET/ENTER key, then MANUAL. The current center frequency is displayed, and may be changed. You can also enter a CF using the LST VAL key. In this case, the CF is set to the value of the last measured frequency, excluding any math functions that may be active. Pressing the SET/ENTER key a second time enters the new CF into memory, and the counter begins counting using the new value.

If you enter a manual CF which is greater than MAX GHz or less than 500 MHz, then an error is displayed. After you clear the error, the counter returns to counting using the previous value. If a CF containing fractional-megahertz values is entered, the fractional portion is truncated on pressing the SET/ENTER key. Refer to page 2-24 of Section 2 for more information on how to use the MANUAL key.

The CF entered should be no more than 20 MHz from the input frequency for inputs in the 1 GHz - MAX GHz range, and no more than 3 MHz from the input frequency for inputs in the 500 MHz - 1 GHz range. If the CF is too far from the input frequency, the counter may display an incorrect measurement.

### Front Panel Display and Annunciators

All HP 5361B display functions appear on a Liquid Crystal Display. Operating modes, math /measurement modifiers, and gate status are shown by arrow annunciators located along the bottom of the display. When lit, these arrows point to the function names marked on the front panel just beneath the LCD readout.

The front panel display consists of 24 LCD characters, as shown in *Figure 3-1*. During measurement and parameter entry, the characters are divided into a parameter section, and a message section.

The parameter display section has 12 digits, grouped in sets of three with blank characters between groups. The message section has 8 characters available, the first is usually blank to serve as a separator between the message section and the parameter section. The content of the display differs for each operating mode. Information on how to use the various HP 5361B functions and their corresponding displays are described in Section 2.

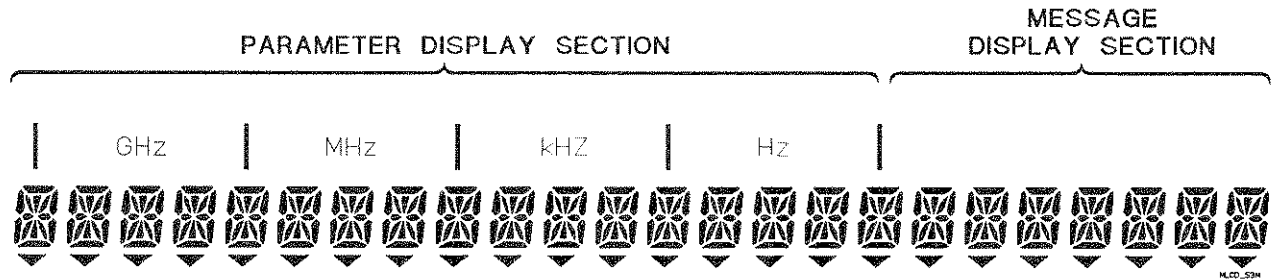

*Figure 3-1. Liquid Crystal Display (LCD)*

### LCD Character Set

*Table 3-2* shows the set of all possible LCD characters that can be formed by the LCD Display. The equivalent ASCII and decimal codes are included for programming the remote display function via HP-IB. Refer to the next section of this manual for HP-IB programming information.

Table 3-2. LCD Character Set

LCD CHAR.	ASCII CHAR.	DECIMAL	LCD CHAR.	ASCII CHAR.	DECIMAL	LCD CHAR.	ASCII CHAR.	DECIMAL
P	@	64	V	V, v	86, 118	←	,	44
A	A, a	65, 97	W	W, w	87, 119	!	-	45
B	B, b	66, 98	X	X, x	88, 120	.	.	46
C	C, c	67, 99	Y	Y, y	89, 121	/	/	47
D	D, d	68, 100	Z	Z, z	90, 122	0	0	48
E	E, e	69, 101	[	[	91	1	1	49
F	F, f	70, 102	\	\	92	2	2	50
G	G, g	71, 103	]	]	93	3	3	51
H	H, h	72, 104	^	^	94	4	4	52
I	I, i	73, 105	_	_	95	5	5	53
J	J, j	74, 106	space	space	32	6	6	54
K	K, k	75, 107	!	!	33	7	7	55
L	L, l	76, 108	"	"	34	8	8	56
M	M, m	77, 109	#	#	35	9	9	57
N	N, n	78, 110	\$	\$	36	:	:	58
O	O, o	79, 111	%	%	37	;	;	59, 123
P	P, p	80, 112	&	&	38	<	<	60, 124
Q	Q, q	81, 113	'	'	39	=	=	61, 125
R	R, r	82, 114	(	(	40	>	>	62, 126
S	S, s	83, 115	)	)	41	?, DEL	?, DEL	63, 127
T	T, t	84, 116	*	*	42			
U	U, u	85, 117	+	+	43			



## Annunciator Descriptions

The various modes and functions of the HP 5361B are labeled on the front panel just beneath the LCD, as shown in *Figure 3-2*. When an operating mode or function is selected, an arrow-shaped annunciator (▼) appears at the lower edge of the display, pointing to the name of the selected mode or function. *Table 3-3* contains a brief description of each front panel annunciator.

*Table 3-3. Front Panel Annunciator Descriptions*

1) OFFSET	The OFFSET annunciator is lit when the Offset function has been enabled. The displayed value is the measured value plus the value of the entered offset.
2) SCALE	The SCALE annunciator is lit when the Scale function has been enabled. The displayed frequency is the measured value multiplied by the scale factor.
3) SMOOTH	The SMOOTH annunciator is lit when the Smooth function has been enabled. Unstable digits of the displayed frequency are masked.
4) AVERAGE	The AVERAGE annunciator is lit when the average function has been enabled for pulse envelope measurements. Multiple measurement samples are averaged to provide a mean value that is shown on the display.
5) HIGH BAND	The HIGH BAND annunciator is lit when option 040 is present with the acquisition mode in high band. The annunciator is off if the acquisition mode is low band or option 040 is absent.
6) ARM	The ARM annunciator is lit when the selected gate mode is arm. Measurement is held off until an external arming signal is applied at the GATE/ARM input.
7) EXT	The EXT annunciator is lit when the selected gate mode is external. The gate is triggered via the front panel GATE/ARM input connector.
8) INT	The INT annunciator is lit when the selected gate mode is internal. The measurements are triggered by internal gating. In this mode sample rate can be set from FAST to HOLD.
9) OPEN	The OPEN annunciator is lit when the gate opens. The duration between appearance of this annunciator depends upon the sample rate setting. This annunciator flashes during measurements to indicate the opening and closing of the gate.
10) HOLD	The HOLD annunciator is lit when the sample rate of the counter is set to the slowest possible rate. When in HOLD, the counter keeps the last measurement until a new measurement is triggered using the front panel TRIGGER key or the HP-IB TRIGGER or TRG command. The annunciator remains on until the sample rate is changed to a rate other than HOLD.
11) REM	The REM annunciator is lit when the counter is under remote control. Refer to Remote Operation via HP-IB in section 4 of this manual, for more information.
12) LSN	The LSN annunciator is lit when the counter is addressed to listen. Refer to Remote Operation via HP-IB in section 4 of this manual, for more information.
13) TLK	The TLK annunciator is lit when the counter is addressed to talk, or when it is being used in the TALK ONLY mode. Refer to Remote Operation via HP-IB in section 4 of this manual, for more information.

Table 3-3. Front Panel Annunciator Descriptions (Continued)

14) SRQ	The SRQ annunciator is lit when a Service Request condition exists in the counter, requiring attention from the controller in charge of the HP-IB. Refer to Remote Operation via HP-IB in section 4 of this manual, for more information.
15) OVEN	The OVEN annunciator is lit if an optional oven oscillator installed in the instrument has not yet reached operating temperature (warming). The annunciator is always off if the standard oscillator is installed.
16) EXT REF	The EXT REF annunciator is automatically lit when an external time base reference (1, 2, 5, or 10 MHz) is connected to the rear panel external reference input. The annunciator goes out as soon as the external reference is disconnected.
17) FM NORM	The FM NORM annunciator is lit when the FM Rate/Track function is set to Normal Rate. The annunciator turns off when the FM Rate/Track function is set to Low Rate or Track, or when the counter is not in AUTO/Pulse frequency measurement mode.
18) LOW	The LOW annunciator is lit when the FM Rate/Track function is set to Low Rate. The annunciator turns off when the FM Rate/Track function is set to Normal Rate or Track, or when the counter is not in AUTO/Pulse frequency measurement mode.
19) TRACK	The TRACK annunciator is lit when the FM Rate/Track function is set to Track. The Track annunciator turns off when the FM Rate/Track function is set to Normal Rate or Low Rate, or when the counter is not in the AUTO/Pulse frequency measurement mode.
20) <50 HZ PRF	The <50 HZ PRF annunciator is lit when the Low PRF measurement function is active. The <50 HZ PRF annunciator turns off when this function is cancelled from either the front panel or by remote command.
21) AUTO	The AUTO annunciator is lit when the counter is set to the Automatic measurement mode (INPUT 1). The annunciator goes out when another measurement mode is selected.
22) MAN	The MAN annunciator is lit when the counter is set to the Manual measurement mode (INPUT 1). The annunciator goes out when another measurement mode is selected.
23) 50Ω	The 50Ω annunciator is lit when the counter is set to the 50Ω Low Frequency mode (INPUT 2). The annunciator goes out when another measurement mode is selected.
24) 1MΩ	The 1MΩ annunciator is lit when the counter is set to the 1MΩ Low Frequency mode (INPUT 2). The annunciator goes out when another measurement mode is selected.

24-character **LIQUID CRYSTAL DISPLAY** performs all measurement and data display functions. During measurement and parameter entry, display is divided into a 12-digit parameter display section, and an 8-character message display section. In extended function mode, all 24 characters are used for alphanumeric display of information.

PARAMETER DISPLAY SECTION

MESSAGE DISPLAY SECTION

**INPUT 2** BNC connector for CW input signals in the 10 Hz-525 MHz range is a special fused connector. The fuse (HP Part No. 2110-0301) is 1/8A, and is accessible (for replacement) from the front panel. 50Ω or 1MΩ input impedance for INPUT 2 is selectable via adjacent front panel keys.

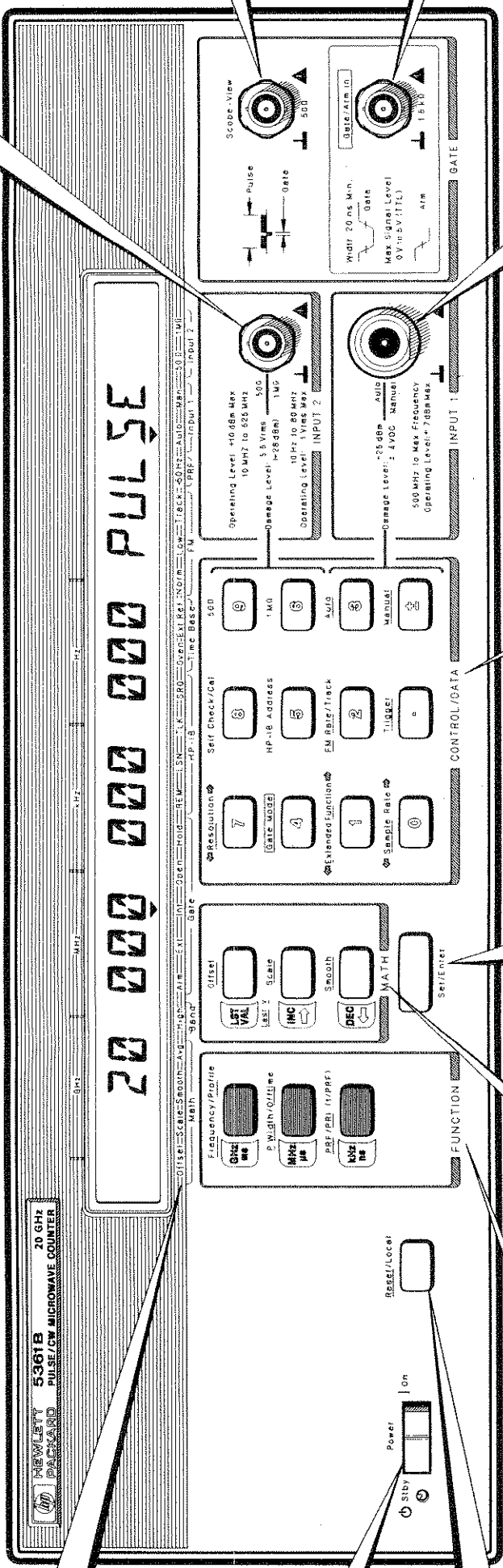

**ANNUNCIATORS** indicate the various modes and functions of the counter, such as gate status, math operations, HP-IB status, and measurement mode status. Small arrows beneath each character in the LCD light or blink, as required, to point to the name of an operating mode or function.

The **POWER** switch applies power to the entire instrument when set to ON. In STBY (Standby), power is applied only to the microprocessor internal RAM for data retention, and the optional oven oscillator (Option 001 or 010).

The **RESET/LOCAL** key aborts any current measurement or parameter entry activity, clears error messages, exits Self Check and extended function modes, and returns the instrument to counting. Returns counter to local operation, if in remote. When preceded by the set/enter key, performs preset.

**FUNCTION** keys provide selection of six different Pulse/CW parameters for measurement and display. Keys also provide parameters entered as GHz, MHz, kHz, and ms, μs, ns.

**MATH** keys provide post-measurement manipulation of displayed data via mathematical operations, OFFSET (±) SCALE (X), and SMOOTH (averaging). Math constants for OFFSET and SCALE functions are entered via the CONTROL/DATA, INC, DEC, and LST VAL keys when MATH entry is enabled.

**SET/ENTER** key is used for parameter entry for various keyboard functions. Pressing this key, and then a function key, sets the counter to accept numeric data entered via the CONTROL/DATA keys. Parameter entry is terminated by pressing the SET/ENTER key a second time (enter the parameter values into memory).

**CONTROL/DATA** keys provide function selection of each measurement and operating mode. During parameter entry, the keys are reassigned to numeric or special entry values labeled on the face of each key.

**HP 5361B INPUT 1** N-type or APC 3.5 connector for input signals in the 500 MHz-MAX GHz range. Automatic and manual measurement modes for INPUT 1 are selectable via adjacent front panel keys. CW or Pulse mode is automatically selected.

**SCOPE-VIEW** GATE + IF sign, or oscilloscope.

**GATE/ARM IN** GATE/ARM sig measurements.



forms all  
ig meas-  
ed into a  
haracter  
n mode,  
isplay of

**INPUT 2** BNC connector for CW input signals in the 10 Hz-525 MHz range is a special fused connector. The fuse (HP Part No. 2110-0301) is 1/8A, and is accessible (for replacement) from the front panel. 50Ω or 1MΩ input impedance for INPUT 2 is selectable via adjacent front panel keys.

DISPLAY SECTION

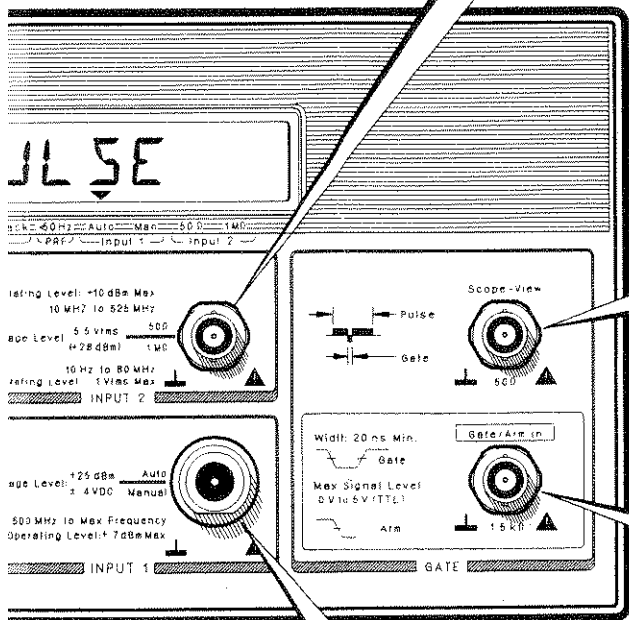

**SCOPE-VIEW** BNC connector for output of combined GATE + IF signal to auxiliary measurement equipment or oscilloscope.

**GATE/ARM IN** BNC connector for external input of GATE/ARM signal during GATE or ARM gate mode measurements.

**HP 5361B INPUT 1** N-type or APC 3.5 connector for input signals in the 500 MHz-MAX GHz range. Automatic and manual measurement modes for INPUT 1 are selectable via adjacent front panel keys. CW or Pulse mode is automatically selected.

Keys provide function selection of  
t and operating mode. During  
keys are reassigned to numeric or  
labeled on the face of each key.

Figure 3-2. Front Panel Features



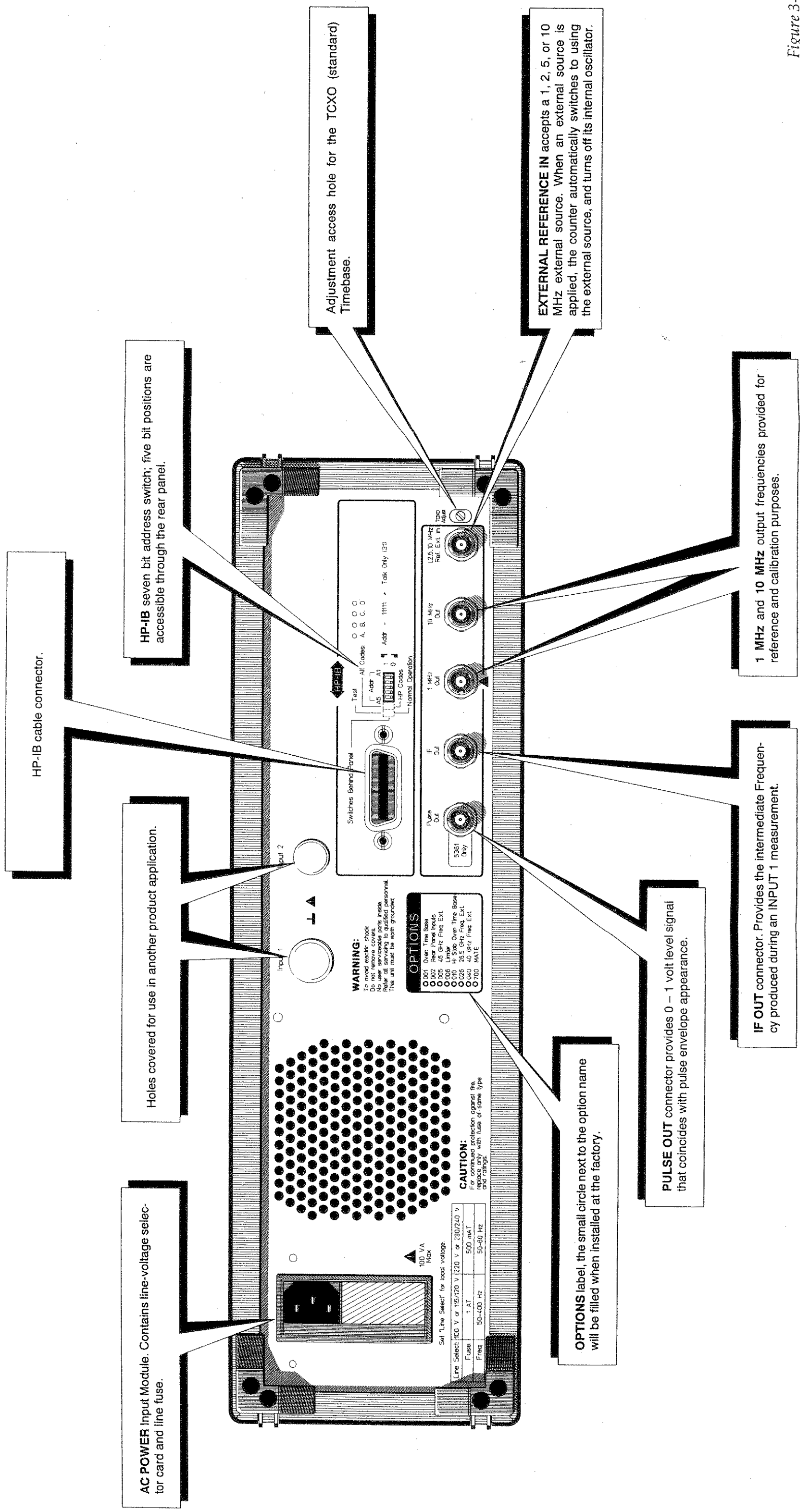

Figure 3-2  
FRONT PANEL FEATURES  
(See Page 3-17)

Figure 3-3  
REAR PANEL FEATURES  
(See Page 3-18)

Figure 3-3. Rear Panel Features





## Front Panel Signal Connectors

The following paragraphs explain each of the four signal connectors located on the front panel (See *Figure 3-2*). The explanations describe the signal type, its functional purpose, and connector. Most details of signal parameters, characteristics, and power levels are discussed in Section 2 and listed in *Table A-1, Specifications*.

- INPUT 1** This connector provides input to the HP 5361B for all microwave pulse and CW signals between 500 MHz and MAX GHz. Automatic and manual measurement modes are selectable via adjacent front panel keys. Connector type is Precision N Female or APC 3.5 Male. Refer to pages 2-16 and 2-18 in Section 2 for information on how to use INPUT 1. Refer to Section 1 for INPUT 1 signal hook-up.
- INPUT 2** This connector provides input to the HP 5361B for all CW signals between 10 Hz and 525 MHz. 50 $\Omega$  or 1 M $\Omega$  impedances are selectable via adjacent front panel keys. Connector type is BNC Female. Refer to pages 2-16 and 2-18 in Section 2 for information on how to use INPUT 2. Refer to Section 1 for INPUT 2 signal hook-up.

## SCOPE-VIEW Output

The SCOPE-VIEW output connector provides a unique composite signal that displays both gate location and width in relation to pulse burst onset and end. This output shows exactly where measurements were taken inside a pulse and combines derived IF signal and Gate pulse in the following way (see *Figure 3-4, SCOPE-VIEW Signal Waveform*): Prior to the onset of a microwave pulse, the output is high at -0.95 volts (nominal).

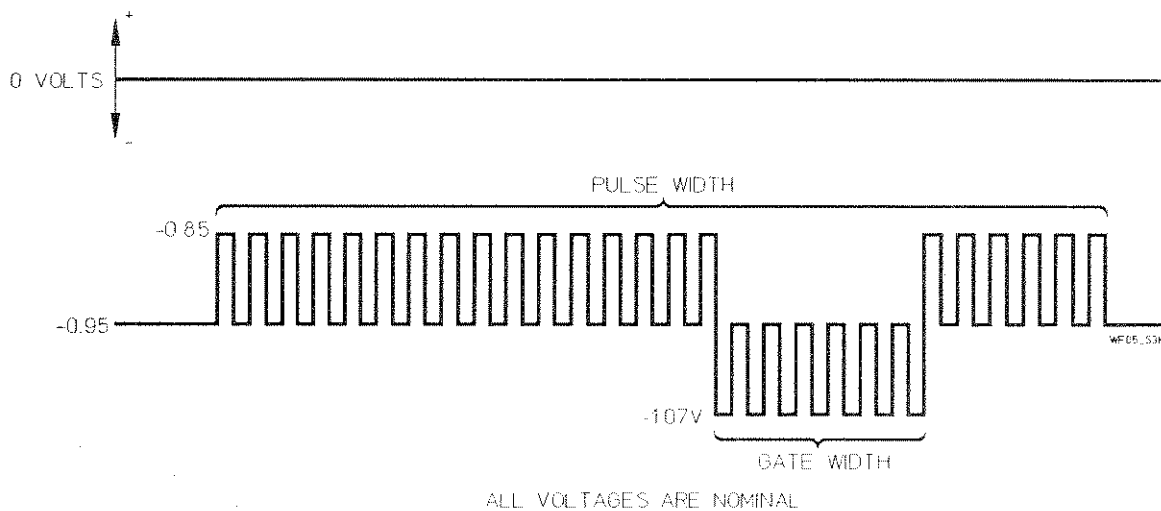

Figure 3-4. SCOPE-VIEW Signal Waveform

At pulse onset the negative side on the digitized IF pulse train is placed on this voltage so the positive side is  $-0.84$  volts. When the gate opens the position of the IF signal is shifted. The positive side of the pulse train rides on  $-0.95$  volts for the duration of the gate time. This places the negative side of the IF pulse train at  $-1.07$  volts. All voltages are nominal and are for indication purposes only. Output impedance is  $50\Omega$ . Connector type is BNC Female. Refer to Sections 1 and 2, and Appendix D for information on how to use the SCOPE-VIEW output.

### GATE/ARM Input

The GATE/ARM IN connector provides TTL input for either the ARM or EXTERNAL gate modes. During ARM mode, measurement is suspended until the Gate/Arm input goes active (TTL edge triggered low), (see Figure 3-5, Gate/Arm In Waveform) at this point a pulse measurement is made only if pulse onset follows arm active by at least 50 ns. During External gate mode the counter will make measurements only when the Gate/Arm input is active (TTL low). Input impedance is  $1.5\text{ K}\Omega$ . Connector type is BNC Female. Refer to pages 2-37 through 2-41 in Section 2 and Appendix D for information on how to use the Gate/Arm input.

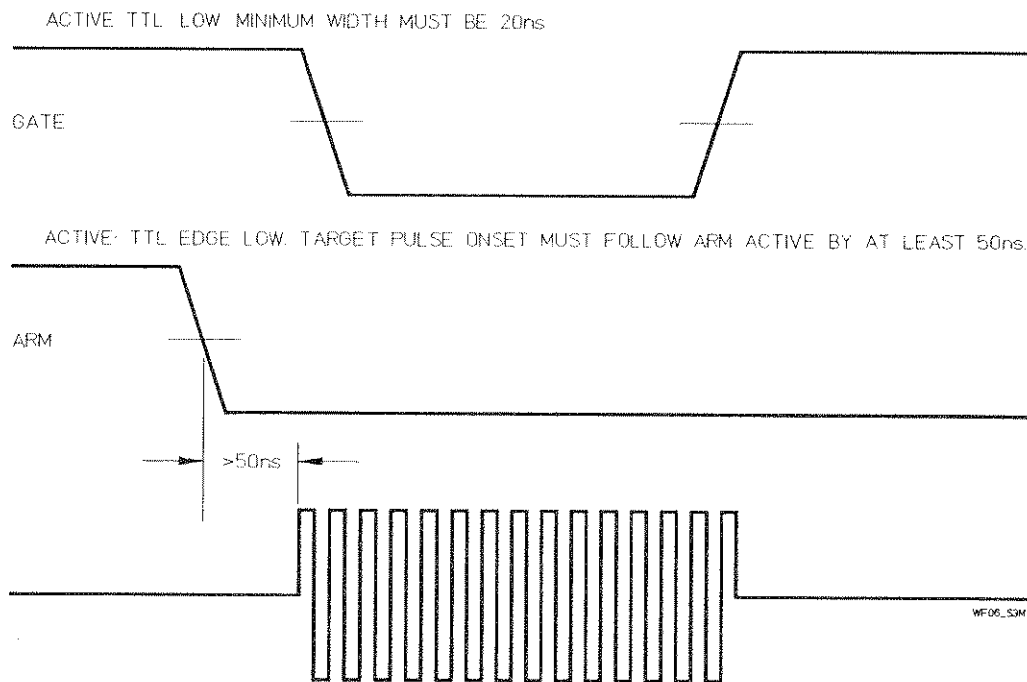

Figure 3-5. Gate/Arm In Waveform

## REAR PANEL FEATURES

The following paragraphs provide you with descriptions of the rear panel features on the HP 5361B. All rear panel features of the instrument are shown in *Figure 3-3*.

### AC Power Input Module

The AC Power Input Module (A13) accepts the three-wire ac power cable (W1), providing operation from 100-, 115/120-, 220-, and 230/240-volt ac sources. The power module contains a printed circuit line voltage selector card, which you must position to agree with the voltage of the power source. When the card is plugged into the module, the number visible in the power module window indicates the line voltage of the ac power source which you must supply to the instrument.

The correct value line fuse must be installed after the card is inserted (Refer to Appendix B, Line Voltage Selection, and *Figure B-1* for further information). The protective grounding conductor connects to the instrument through this module.

**TCXO Adjustment**

This opening in the rear panel allows you to adjust the Temperature Compensated Crystal Oscillator standard timebase (but not the optional oven oscillators) without removing the instrument covers. Refer to Section 1 of the Service manual for timebase calibration instructions.

**HP-IB Connector**

The input/output interface connector provides remote control capabilities with the Hewlett-Packard Interface Bus (HP-IB). For a complete description of the HP-IB capabilities, refer to the Remote Operation via HP-IB section of this manual and page 2-80 of Section 2.

**HP-IB Address Switch**

The HP-IB Interface Address Switch (ADDR) is a group of seven switches used to manually set the remote control address of the counter. The five switch positions to the right are externally accessible for setting the address. The two switch positions to the left are not used for normal operation. For a complete description of address selection, refer to *Table 4-1, Address Selection*, in the Remote Operation via HP-IB section of this manual.

**External Reference In**

An external reference input lets you connect a 1 MHz, 2 MHz, 5 MHz, or 10 MHz reference source. If an external reference source is applied to this input, the counter automatically switches to the external reference input as its timebase source, and turns off the TCXO standard timebase.

If an oven oscillator is installed, power to the oven is maintained, but the internal oscillator signal is disconnected. A detection circuit in the timebase buffer sends a control signal to the microprocessor and the EXT REF annunciator is lit to show that an external source is used. External reference requirements are listed in *Table A- 1, Specifications*.

Use this input when you need to lock the counter's internal timing circuitry to auxiliary/external test and measurement equipment. When connected, an external timebase input ensures minimal timing error.

**1 MHz Out,  
10 MHz Out**

Two rear panel signal outputs, 1 MHz and 10 MHz, are available for reference and calibration. The signals remain present when the instrument is in Standby and as long as ac

power is connected to the instrument. Refer to *Table A-1, Specifications*, for output signal specifications.

**IF Out** This output provides the IF signal resulting from the mixing of the input and LO harmonic frequencies for monitoring with auxiliary measurement equipment. This signal is available only when a high frequency (INPUT 1) measurement is made. Refer to *Table A-1* for IF output specifications.

**Pulse Out** This output provides a 0 to 1 volt signal that corresponds to the onset and end of a microwave pulse. The Pulse Out signal goes low at the onset of an INPUT 1 microwave burst and switches high when it ends. This output reflects the microwave burst event timing only and does not contain any analog data. Pulse Out is active only for pulse measurements while staying low during CW measurements.

You can use this output to trigger a delaying pulse generator or time synthesizer for tasks such as pulse profiling or other time-delayed measurement. Refer to *Table A-1, Specifications*, for output signal specifications.



## REMOTE OPERATION VIA HP-IB

---

### SECTION GUIDE

This section provides you with programming information for remote operation of the 5361B. Most of the counter's front panel functions can be remotely operated via the Hewlett-Packard Interface Bus (HP-IB), as well as additional functions not available from the front panel. Some of the commands described in this section are functional only when Option 040 is installed.

You should be familiar with the Hewlett-Packard Interface Bus, the selected controller, the configured interface, local operation, and functional capabilities of the HP 5361B. If you need more information about HP-IB, refer to one or more of the following documents:

- IEEE Standard 488-1978
- ANSI Standard MC1.1
- Improving Measurements in Engineering and Manufacturing (HP part number 5952-0058)
- Tutorial Description of the Hewlett-Packard Interface Bus (HP part number 5952-0156)

You can use the following lists as an aid to quickly find the information you need.

### Where to Find Important Topics:

- |  |         |
|--|---------|
| ■ Errors                               | pg 4-22 |
| ■ Examples of HP-IB Programs           | pg 4-48 |
| ■ HP-IB Command Descriptions           | pg 4-23 |
| ■ HP-IB Configuration                  | pg 4-2  |
| ■ Interface Functions and Capabilities | pg 4-4  |
| ■ Meta Messages                        | pg 4-7  |
| ■ Output Formats                       | pg 4-19 |
| ■ Status Request and Status Byte       | pg 4-10 |
| ■ Syntax                               | pg 4-12 |

<b>Section Summary</b>	■ Section Guide	pg 4-1
	■ Selecting the HP-IB Address	pg 4-2
	■ HP 5361B Interface Capabilities	pg 4-4
	■ Interface Commands	pg 4-5
	■ Checking Instrument Status	pg 4-9
	■ Data Input	pg 4-12
	■ Data Output	pg 4-19
	■ Error Handling	pg 4-22
	■ HP-IB Command Descriptions	pg 4-23
	■ Programming Examples	pg 4-48

## SELECTING THE HP-IB ADDRESS

To use the HP 5361B in an HP-IB system, you must set the counter to the desired address, as shown in *Figure 4-1*. The Addressable mode is used whenever a controller is used with the system and the HP 5361B is functioning as both a talker and a listener. The Talk Only mode is used when the counter is operating under its own control (no controller on the bus) and sending measurement results to another device on the bus (such as a printer). In the Talk Only mode, the HP 5361B will not output any EFUN results, functioning as an output-only device, and the receiving device must be set to the Listen Only mode.

You can set the HP-IB address for the HP 5361B in one of two ways: the front panel keyboard or the address switch on the rear panel. The address setting of the rear panel switch is the default address if ac power has been removed and then restored to the counter. If the counter is switched to Standby (STBY setting of the POWER switch), the address set via the front panel keyboard is retained as the HP-IB address. Refer to the lower portion of *Figure 4-1* for all possible address settings and the corresponding ASCII codes for Talk and Listen (in the Addressable mode) and in the Talk Only mode. *Figure 4-1* shows an example of a rear panel switch setting of Address 14.

To set the HP-IB address via the front panel keyboard, press the following key sequence:

SET/ENTER

HP-IB ADDRESS

(digits) (Control/Data key group)

SET/ENTER



You can also display the HP-IB address by simply pressing the HP-IB ADDRESS key. The counter displays the currently selected HP-IB address as long as the key is held down. When you release the HP-IB ADDRESS key, the counter returns to the previous display.

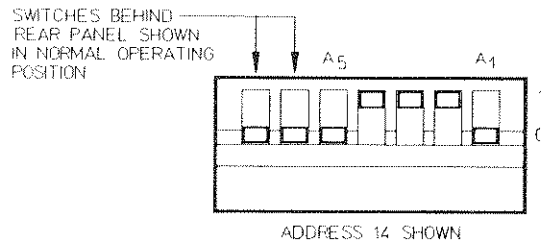

**NOTE** —————  
 Select the HP-IB address from the table below and set the address switches.

SELECTED ADDRESS	ADDRESS SWITCHES					ASCII CHARACTER		ADDRESS USAGE MODE
	A <sub>5</sub>	A <sub>4</sub>	A <sub>3</sub>	A <sub>2</sub>	A <sub>1</sub>	LISTEN	TALK	
00	0	0	0	0	0	SP	@	ADDRESSABLE
01	0	0	0	0	1	!	A	ADDRESSABLE
02	0	0	0	1	0	"	B	ADDRESSABLE
03	0	0	0	1	1	#	C	ADDRESSABLE
04	0	0	1	0	0	\$	D	ADDRESSABLE
05	0	0	1	0	1	%	E	ADDRESSABLE
06	0	0	1	1	0	&	F	ADDRESSABLE
07	0	0	1	1	1	'	G	ADDRESSABLE
08	0	1	0	0	0	(	H	ADDRESSABLE
09	0	1	0	0	1	)	I	ADDRESSABLE
10	0	1	0	1	0	*	J	ADDRESSABLE
11	0	1	0	1	1	+	K	ADDRESSABLE
12	0	1	1	0	0	,	L	ADDRESSABLE
13	0	1	1	0	1	-	M	ADDRESSABLE
14	0	1	1	1	0	.	N	ADDRESSABLE
15	0	1	1	1	1	/	O	ADDRESSABLE
16	1	0	0	0	0	0	P	ADDRESSABLE
17	1	0	0	0	1	1	Q	ADDRESSABLE
18	1	0	0	1	0	2	R	ADDRESSABLE
19	1	0	0	1	1	3	S	ADDRESSABLE
20	1	0	1	0	0	4	T	ADDRESSABLE
21	1	0	1	0	1	5	U	ADDRESSABLE
22	1	0	1	1	0	6	V	ADDRESSABLE
23	1	0	1	1	1	7	W	ADDRESSABLE
24	1	1	0	0	0	8	X	ADDRESSABLE
25	1	1	0	0	1	9	Y	ADDRESSABLE
26	1	1	0	1	0	:	Z	ADDRESSABLE
27	1	1	0	1	1	;	[	ADDRESSABLE
28	1	1	1	0	0	<	\	ADDRESSABLE
29	1	1	1	0	1	>	]	ADDRESSABLE
30	1	1	1	1	0	>	~	ADDRESSABLE
31	1	1	1	1	1	N/A	N/A	TALK ONLY

Note: Be sure that the instrument address is not set to the same address as the controller. Typical HP controllers use address "21" as a preset address, thus the use of address "21" as the HP 5361B address code should be avoided.

Figure 4-1. Address Selection

## HP 5361B INTERFACE CAPABILITIES

The HP 5361B HP-IB interface capabilities are listed in *Table 4-1*. The table lists the interface functions defined in the IEEE 488-1978 standard by name and specific 5361B subset identifier, and contains a brief description of the counter's capability for each function.

*Table 4-1. HP 5361B HP-IB Interface Function Capabilities*

Name and Mnemonic	General Description	Subset Identifier	Specific HP 5361B Capability
Source Handshake (SH)	Capability to properly translate a multiline message.	SH1	The 5361B can generate messages.
Acceptor Handshake (AH)	Capability to guarantee proper reception of remote multiline messages.	AH1	The 5361B can interpret received messages.
Talker (T)	Capability to transmit data over the bus when addressed.	T5	The 5361B can function as a talker. In addition, it can operate as a Talk Only instrument and will respond to serial poll. It will unlisten if addressed as a talker.
Extended Talker (TE)	Talker capability with address extension.	TE0	The 5361B cannot function as an extended talker.
Listener (L)	Capability to receive data over the bus when addressed.	L4	The 5361B can function as a listener. In addition, it will untalk if addressed as a listener.
Extended Listener (LE)	Listener capability with address extension.	LE0	The 5361B cannot function as an extended listener.
Service Request (SR)	Capability permitting a device to asynchronously request service from the controller.	SR1	The 5361B can generate a service request.
Remote/Local (RL)	Capability to select between two sources of input information: local (front panel controls) and remote (input information from the bus).	RL1	The 5361B can operate both in remote and local modes. In addition, it can respond to local lockout.
Parallel Poll (PP)	Provides capability for a device to uniquely identify itself if it requires service and the controller is requesting a response. This capability differs from service request in that it requires a commitment of the controller to periodically conduct a parallel poll.	PP0	The 5361B does not support parallel poll.

Table 4-1. HP 5361B HP-IB Interface Function Capabilities (Continued)

Name and Mnemonic	General Description	Subset Identifier	Specific HP 5361B Capability
Device Clear (DC)	This function allows a device to be initialized to a predefined state.	DC1	The 5361B supports both the Device Clear (DCL) and Selected Device Clear (SDC) commands.
Device Trigger (DT)	This function permits a device to have its basic operation initiated by the talker on the bus.	DT1	The 5361B can be remotely triggered.
Controller (C)	This function permits a device to send addresses, universal commands, and addressed commands to other devices on the HP-IB. It may also include the ability to conduct polling to determine devices requiring service.	C0	The 5361B cannot function as a controller.
Drivers (E)	This code describes the type of electrical drivers used in a device.	E2	The 5361B has three-state drivers.

## INTERFACE COMMANDS

The commands recognized by the HP 5361B can be separated into two classes: device independent commands and device dependent commands. Device independent commands are defined by the interface standard document and are the same for all instruments. Refer to Device Independent Commands below for a description of these commands.

Device dependent commands are unique to an instrument and are a function of instrument design. Refer to HP-IB COMMAND DESCRIPTIONS for descriptions of all HP 5361B device dependent commands.

## Device Independent Commands

Table 4-2 lists the supported device independent commands by their mnemonics, and includes the full name and a brief description of each command.

Table 4-2. Device Independent Commands

Mnemonic	Command Name	Description
ATN	Attention	Alerts the instrument of each device independent message being sent, so the instrument is ready to accept data and interpret them as commands.
DCL	Device Clear	This command clears all errors, aborts all partially completed commands and pending send data commands, and clears all input and output buffers.
EOI	End Or Identify	If ATN is false and the instrument is a listener, EOI acts as a message delimiter, and indicates the last data byte of a multibyte sequence.
GET	Group Execute Trigger	If the instrument is addressed to listen, GET aborts the current measurement, and triggers the next measurement immediately.
GTL	Go To Local	If the instrument is addressed to listen, GTL returns the instrument to front panel (local) operation. Local Lockout is not cleared.
IFC	Interface Clear	The instrument untalks and unlistens, and the interface initializes to an idle state (no activity on the bus).
LADn	Listen Address n	If n matches the instrument address, the instrument becomes a listener.
LLO	Local Lockout	The front panel LOCAL key is disabled if the instrument is in remote mode.
MLA	My Listen Address	MLA is the listen address (LADn) that matches the instrument address.
MTA	My Talk Address	MTA is the talker address (TADn) that matches the instrument address.
NRE	Not Remote Enable	The instrument returns to front panel (local) operation; Local Lockout is cleared.
NUL	Null	No effect when received by the instrument.
REN	Remote Enable	The instrument enters the remote state, and is enabled to respond to interface commands when addressed as a listener.
SDC	Selected Device Clear	If the instrument is a listener, will cause the same response as DCL.
SPD	Serial Poll Disable	Terminates serial polling, and returns the instrument to a normal talker state to output device dependent data rather than status information.

Table 4-2. Device Independent Commands (Continued)

Mnemonic	Command Name	Description
SPE	Serial Poll Enable	Establishes serial polling, and enables the instrument to send the serial poll status byte when addressed to talk.
TADn	Talk Address n	If n matches the instrument address, the instrument becomes a talker.
UNL	Unlisten	The instrument is unaddressed and terminates listening. A single device cannot be unaddressed without unaddressing all listeners.
UNT	Untalk	Unaddresses the instrument, if currently a talker, and terminates talking. Addressing another talker on the interface automatically unaddresses any current talker.

## Meta Messages

To simplify the use of an HP-IB system, you may send meta messages to command to the counter. A meta message is a useful sequence of device independent commands which have been combined into a single string. For example, sending "CLEAR 714" is equivalent to sending the sequence "ATN,UNL,MTA,LAD14,SDC".

Many of the meta messages can be sent either with addressing (a particular destination) or without addressing (All devices on the bus). The addressed form will normally go to a particular device. For example, the command REMOTE 7 will send the Remote Enable (REN) command without making any device a listener; the command REMOTE 714 will send Remote Enable and make the device at address 14 a listener.

Table 4-3 lists 12 meta messages by name, and includes a description of the command function, corresponding interface message sequence, and HP 5361B response. The examples listed use the addressed form of the command. The interface message sequences are typical in that different controllers may send different sequences for a given meta message, but will produce the same results.

Table 4-3. Meta Message Reference Table

Meta Message	Command Sequence	General Description	Specific HP 5361B Response
DATA	UNL, MTA, LADn, data	Transfers device dependent information from one device to one or more devices on the bus.	The 5361B sends measurement data as defined by the device dependent command received from the controller.
TRIGGER	UNL, MTA, LADn, GET	Causes a group of selected devices to simultaneously initiate a set of device dependent actions.	Starts a new measurement.
CLEAR	UNL, MTA, LADn, SDC	Causes the instrument to be set to a predefined state, such as a certain range or function.	Causes the 5361B to clear any errors present, clears all input and output buffers, and resets the hardware for a new measurement.
REMOTE	REN, UNL, MTA, LADn	Permits selected devices to be set to remote operation, allowing parameters and device characteristics to be controlled by bus messages.	Causes the 5361B to go to remote operation if REN is true, and if instrument is addressed to listen. Locks out all front panel keys except LOCAL; instrument is controlled by bus messages. Until changed via the bus, remote operation is according to state of front panel settings just prior to going to remote.
LOCAL	UNL, MTA, LADn, GTL	Causes selected devices to return to local (front panel) operation.	Returns the 5361B to front panel control. Instrument status is that set just prior to receipt of the Local message.
LOCAL LOCKOUT	LLO	Disables local (front panel) controls of selected devices.	Disables LOCAL key. The 5361B remains in remote operation until a Local message is received on the bus.
LOCAL/CLEAR LOCAL LOCKOUT	LCLL	Returns all devices to local (front panel) control and simultaneously clears the Local Lockout message.	Returns 5361B to local control and clears Local Lockout message.
SERVICE REQUEST	SRQ	Indicates a device's need for interaction with the controller.	The 5361B will send a Service Request message to the controller under certain conditions, as defined by the settings of the Event Status Enable and Hardware Status Enable registers.  This message is ignored by the 5361B when received.
STATUS BYTE	UNL, MLA, TADn, SPE, data, SPD, UNT	Presents status information of a particular device; one bit indicates whether or not the device currently requires service, the other seven bits (optional) are used to indicate the type of service required.	The 5361B sends status information to the controller. The assignment of the bits in the Status Byte are shown in Table 4-4.

Table 4-3. Meta Message Reference Table (Continued)

Meta Message	Command Sequence	General Description	Specific HP 5361B Response
STATUS BIT	Not applicable	A single bit of device-dependent status information which may be logically combined with status bit information from other devices on the controller.	The 5361B does not use this message.
PASS CONTROL	Not applicable	Passes bus controller responsibilities from the current controller to a device which can assume the bus supervisory role.	The 5361B does not use this message.
ABORT	IFC	Unconditionally terminates bus communications and returns control to the system controller.	All HP-IB activity terminated and control returns to the system controller. Talk and Listen are cleared for the 5361B and all other devices on the bus, which terminates all bus communications. The 5361B status remains as it was just prior to receipt of the Abort message. Any partially entered HP-IB data message is aborted.

### CHECKING INSTRUMENT STATUS

The following paragraphs describe how to check the interface status of the HP 5361B. You can check the interface function and status by observing the front panel status annunciators and reading the status byte.

In addition to indicating its interface function, the counter can generate a Service Request (SRQ) to the controller to indicate a need for attention, and can interrupt the current sequence of events. The Service Request is indicated by the setting of a bit in the status byte and by the front panel SRQ annunciator. You can select the conditions that generate an SRQ by using the service request mask. Refer to the descriptions below for detailed information about these interface status features.

### Front Panel Instrument Status Annunciators

The counter shows its remote status on the front panel via four Interface Status annunciators in the liquid crystal display. An arrow appears at the bottom of the display just above the name of the active function to indicate the interface status. The four interface functions are REM (Remote), LSN (Listen), TLK (Talk), and SRQ (Service Request). The REM annunciator lights when the counter is under remote control. The LSN annunciator lights to indicate that the counter is addressed to listen (receive commands). The TLK annunciator is lit when the counter is addressed to talk (send data). The SRQ annunciator is lit when the counter sends a service request to the controller.

### SRQ and Status Byte

The controller can read the counter status byte at any time to check selected operating conditions. Each bit of the status byte can be individually set to "1" by the counter to indicate that a particular condition has occurred, and can be enabled to send a service request (SRQ) to the controller. *Table 4-4* lists and defines the bits in the status byte.

*Table 4-4. Status Byte*

Bit #	Binary Weight	Status Bit Condition
7	128	Not used.
6	64	RQS (Request Service) - High indicates that the 5361B has a reason for requesting service.
5	32	POWER-ON - The power switch has been set to ON, and the power-up Self Check is completed.
4	16	LOCAL - The counter is under local control.
3	8	LEVEL - A level condition may exist on INPUT 1.
2	4	ERROR - An Error condition exists.
1	2	MEASUREMENT COMPLETE - A measurement has been completed and is available for collection.
0	1	DATA READY - The counter has responded to a request for data and is ready to output the data.

The counter can send a service request to the controller to indicate a need for attention, and can interrupt the current sequence of events. An SRQ typically indicates that data is ready to transmit and/or that an abnormal condition exists, as shown in *Table 4-4*. The counter sends an SRQ to the controller



after a 0 to 1 transition of an enabled condition, if you have set the Service Request Mask to cause (enable) that condition to generate an SRQ. Refer to the paragraph titled Service Request Mask below for information about setting the service request mask.

After SRQ has been sent, the controller conducts a serial poll of all devices on the bus, reading the status byte from each device to identify which condition or conditions caused the SRQ. Remember, when the HP 5361B status byte is read, all current conditions are set to 1, whether or not they are enabled as a condition to generate SRQ.

When polled, the counter returns a number that is the decimal equivalent to the sum of the binary-weighted bits that have been set (refer to the column labeled Binary Weight in *Table 4-4*). For example, a returned value of 38 (equivalent to  $32+4+2$ ) signifies that the POWER ON, ERROR, and MEASUREMENT COMPLETE bits are set (bit=1).

Bit 7 is not used (i.e., it is always 0). Bit 6 (RQS FLAG) is only set if you have enabled one of the other bits in the status byte as a condition to generate an SRQ by setting the service request mask. The special function of the RQS FLAG bit is described under Service Request Mask below.

## Service Request Mask

You can use the service request mask (SRQMASK command) to select which of the bits in the status byte generate an SRQ. Any bit in the status byte, except RQS FLAG (bit 6) and POWER ON (bit 5), can be masked to prevent an SRQ from being generated even if the condition exists.

To set the service request mask, send the SRQMASK,*n* command, where "*n*" is the decimal equivalent of the binary sum of the bits that you want enabled (unmasked). (Refer to the column labeled Binary Weights in *Table 4-5* to select the equivalent decimal value.) The value of "*n*" may be any number from 0 to 255. All SRQ conditions can be masked (disabled) by sending "SRQMASK,0". If all SRQ conditions are masked, none of the conditions will generate an SRQ.

Table 4-5. Service Request Mask

	D7	D6	D5	D4	D3	D2	D1	D0
Service Request Mask	(Don't care)	(Don't care)	(Don't care)	LOCAL	LEVELED	ERROR	MEAS. COMPLETE	DATA READY
Status Byte	(Always zero)	RQS FLAG	POWER ON	LOCAL	LEVELED	ERROR	MEAS. COMPLETE	DATA READY
Binary Weight	128	64	32	16	8	4	2	1

After receiving the SRQMASK,n command, the counter will load the binary value of "n" into the service request mask register. For example, sending "SRQMASK,13" (13=8+4+1) will cause the counter to generate an SRQ and set bit 6 (RQS FLAG) if a level or error condition exists or when measurement data is ready. If the measurement output overflows, or if the counter cannot acquire, then the DATA READY will not generate an SRQ. See DATA OUTPUT for more information.

Notice that in Table 4-5, bit 6 (corresponding to the RQS FLAG bit in the status byte) is a "don't care". This is so because the RQS FLAG bit in the status byte will only be set if one of the other bits in the status byte is set AND you have set the corresponding bit in the service request mask to generate an SRQ.

## DATA INPUT

You can program almost all counter functions via the bus using the specific HP-IB programming codes (device dependent commands). The HP-IB commands for the HP 5361B are summarized in the HP-IB COMMAND DESCRIPTIONS subsection. The following paragraphs describe the syntax and format for sending HP-IB commands to the counter.

### Syntax

In the following paragraphs, syntax diagrams are used to show the format you should use when sending HP-IB programming commands to the counter. When using these diagrams, remember that:

- a. All characters enclosed by a rounded envelope must be entered exactly as shown.
- b. Words enclosed by a rectangular box are names of items used in the commands, and are described in the text.
- c. Items contained within circles indicate required literals, which must occur in the command syntax exactly as shown.
- d. Command elements, connected by lines, can be followed in one direction only, as indicated by the arrowhead at the end of the line. Any combination of command elements that can be generated by following the lines in the proper direction is correct syntax.

---

**NOTE**

*Spaces are not shown in all places where they may occur. You may place spaces between command mnemonics and data in the command string to gain greater clarity, but spaces within command mnemonics and within data are not allowed.*

---

There are four possible types of command elements: command mnemonics (referred to as "headers" ), data, command separators, and data separators. A command can consist of a header alone or a header followed by one or more fields of data. A separator is required between headers and data, between data fields, and between each command, as shown in *Figure 4-2*.

*Figure 4-2.  
Command Syntax*

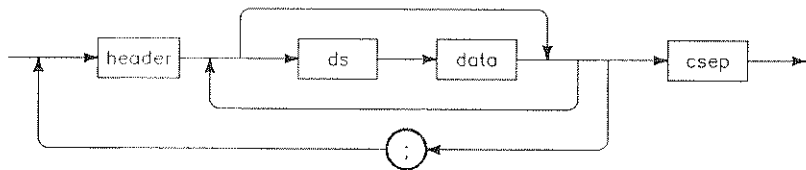

## Command Headers

All HP-IB commands require a command header. Command headers, where possible, consist of the full English word for the corresponding function, up to a maximum of eight characters in length. Function names which require more than eight characters or more than one word are abbreviated.

There are two types of command headers: program messages and queries. Program messages are commands which instruct the counter to perform a particular action. Queries cause data to be returned to the controller; a query header includes a question mark (?) as the last character of the header.

Table 4-6 contains a summary of all the command headers for the HP 5361B. The table is divided into two parts: program message headers and query headers.

The counter accepts commands in either upper or lower case. All characters are converted to upper case before interpretation. In addition, parity bits are ignored. For example, the following two strings will produce identical results:

OUTPUT 714; "OFFSET, LASTV, ON"  
OUTPUT 714; "offset, lastv, on"

Table 4-6. Command Headers

Program Message Headers:	
RESET	Restart measurement; clear any errors
CLR	Same as Device Clear message
INIT	Instrument initialization
AUTO	Input 1, Auto acquisition mode
MANUAL	Input 1, Manual acquisition mode
LOWZ	Input 2, 50Ω
HIGHZ	Input 2, 1 MΩ
FREQ	Pulse or CW carrier frequency
PRF	Pulse Repetition Frequency
PRI	Pulse Repetition Interval
PWID	Pulse Width
OFFT	Pulse Off Time
LPRF	Low Pulse Repetition Frequency
GATE	Gate Mode
TRIGGER	Trigger
TRG	Same as Trigger
AVER	Average
RESOL	Resolution
SAMPLE	Sample Rate

Table 4-6. Command Headers (Continued)

CHIRP	Chirp Mode
GWID	Gate Width
MMOD	Set Measurement Mode
NPUL	Narrow Pulse Mode
PAVER	Pulse Averaging
FMRATE	FM Rate/Track
OFFSET	Offset
SCALE	Scale
SMOOTH	Smooth
HIRESOL	High Resolution
EFUN	Extended Function
EFUNPARM	Extended Function Parameter Entry
DISPLAY	Message display/Display concealment
SRQMASK	Service request mask
DUMP	Fastest measurement: 100 reading/second
SET	Accept instrument setup
SLEEP	Disable INPUT 1 circuit
HARMDET	Harmonic number determination
DATAPTS	Data Points
EDELTA	Event Delta
ESTART	Event Start
FINE	Fine/Coarse
HIGHBAND	Set High Frequency Band (Opt 040 Only)
LOWBAND	Set Low Frequency Band (Opt 040 Only)
PROF	Profile Frequency
PROFTIME	Profile Time Data
SETIF	Set IF for Manual Frequency
TFINAL	Set Profile Stop Time
TSTART	Set Profile Start Time

**Query Headers:**

FUNC?	Send Measurement Function
TEST?	Send Self Check results
EFUN?	Send Extended Function Results
KEY?	Send number of last key pressed
ID?	Send device model number
SET?	Send instrument setup
ERR?	Send error number
REV?	Send firmware revision date code
SER?	Send serial number
REF?	Send timebase reference status
OVEN?	Send oven status
FREQBAND?	Send Frequency Band (Opt 040 Only)
HARM?	Send Harmonic Number
IFPER?	Send IF Periods Per Step
LO?	Send LO Frequency
PROFAVG?	Send Profile Number of Averages
SIDEBAND?	Send Sideband Position

## Command Separators

Command separators are required although not shown in the detailed syntax diagrams that appear later in this section.

The END command separator is only sent with the last byte of the command.

Figure 4-3.  
Command Separators

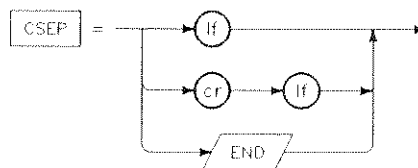

## Data Separators

Data separators are required between headers and data, and between data fields. A <comma> is the preferred separator, but a <space> may also be used as a separator. In the detailed command syntax diagrams shown later in this section, both types of separators are represented by "ds", as shown in Figure 4-4.

Figure 4-4.  
Data Separators

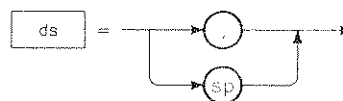

### NOTE

*In all subsequent syntax diagrams, either of the graphic representations shown in Figure 4-4 may be used.*

## Data Formats

Commands may have none, one, or two pieces of data as part of the program message. There are three types of data:

**Numeric data** — Used for function settings that require the entry of a number.

**Character data** — Used for function settings that are not inherently numeric, or that set a binary condition (i.e., ON/OFF settings).

**String data** — Used for displaying messages on the 24-character Liquid Crystal Display on the front panel, and for sending setup information (using the SET command).

**Numeric Data  
(NR1, NR2, NR3)**

Functions that expect you to input a number, such as a manual center frequency, offset frequency, scale factor, and others, require numeric data. Numeric data entry is a "free-format" input, i.e. spaces are allowed before and after a numeric character is entered. Spaces are not allowed within a number. A decimal point and an exponent are allowed, but not required. The preferred syntax for the three numeric data types (nr1, nr2, and nr3) are shown in Figure 4-5.

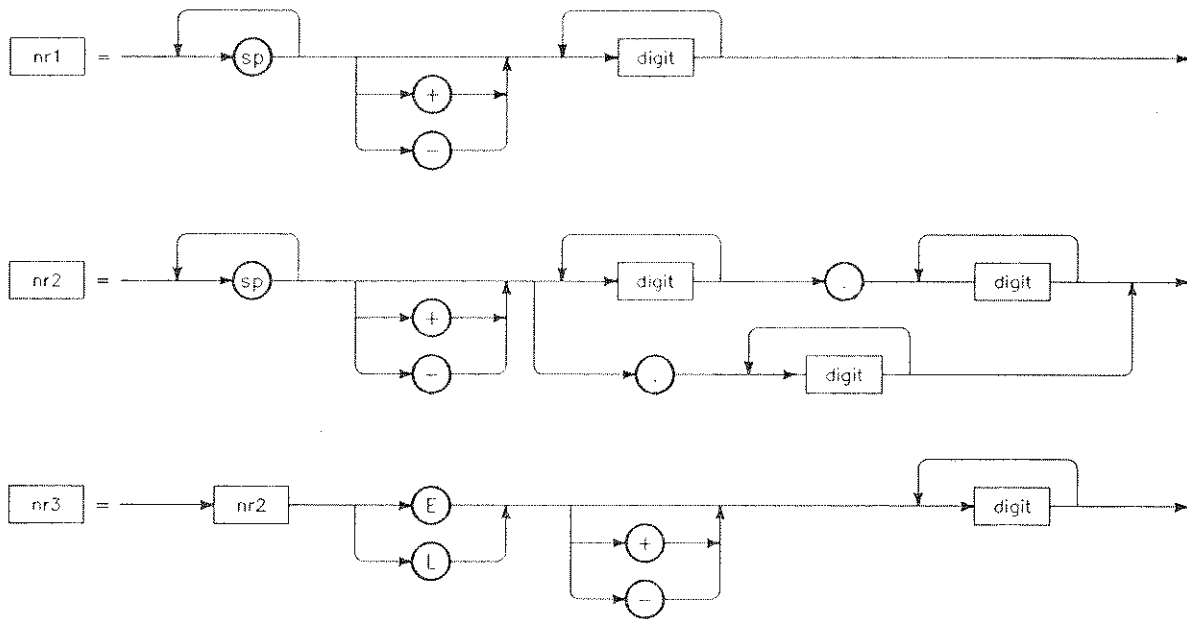

Figure 4-5. Numeric Data Types

If numeric data is required by a program message, it can be entered in integer, real, or floating point form. For example, the following command strings are equivalent:

OUTPUT 714;"MANUAL,500000000"  
 OUTPUT 714;"MANUAL,5E+08"

Program messages that require integer data (such as the RESOL or EFUN commands) will round any non-integer data to the nearest integer. For example, the following command strings are permitted, and equivalent:

OUTPUT 714;"RESOL,0.9"  
 OUTPUT 714;"RESOL,1"

**Character Data**

Character data is used for those functions not requiring numbers, such as the FAST or HOLD setting for the sample rate function. Character data is also used for setting discrete conditions such as the ON/OFF setting of the smooth function. *Table 4-7* lists the allowable characters that can be included in a command to the HP 5361B.

*Table 4-7. Character Data*

Data	Definition
ON	Turn function on.
OFF	Turn function off.
LASTV	Use last value as a frequency or pulse value entry.
NORMAL	Set FM Rate/Track function for NORMAL FM rate.
LOW	Set FM Rate/Track function for LOW FM rate.
TRACK	Set FM Rate/Track function for TRACK rate.
INT	Set Gate mode to Internal
EXT	Set Gate mode to External
ARM	Set Gate mode to Arm
FAST	Repeat measurement as quickly as possible.
HOLD	Hold last measurement until new measurement is triggered.
CW	Set Measurement Mode to CW
PULSE	Set Measurement Mode to Pulse
AUTO	Set Measurement Mode to automatically determine CW or Pulse, Set pulse averages (PAVER) to automatic, Set gate width (GWID) to automatic.
TIME	Set gate width in time.
EVENT	Set gate width in events.



## String Data

String data is similar to character data except that the characters are enclosed in quotes (" "). This format allows special characters, such as <comma>, <space>, and <semicolon> to be sent as data. String data is used with the DISPLAY command for displaying messages on the front panel Liquid Crystal Display (LCD) assembly, and also with the SET command for sending ASCII hexadecimal characters.

## Value Specifier

You can specify a value (frequency or time) by sending a number in one of the three numeric data formats or by sending "LASTV" (the last value measured). All values entered are in hertz or time units.

## DATA OUTPUT

The following paragraphs describe the output format for each type of data returned over the bus by the HP 5361B.

### Measurement Output Formats

Measurement Output Formats vary depending on whether the trigger is "OPEN" (OPEN annunciator on) or set to HOLD. Output format also varies for Dump mode and Extended functions. The following paragraphs explain these differences.

The HP 5361B makes repeated measurements unless set to HOLD. At the end of each measurement cycle, HP-IB status is checked and, if the counter is addressed to talk, the latest measurement is output to the interface. After the next measurement cycle, the previously sent measurement is overwritten if not read by the controller or otherwise sent onto the bus. If the counter is not addressed to talk, no measurements are output to the interface.

When the counter is set to HOLD, no measurement is made until a trigger is received. After the trigger, a single measurement is made. The measurement result is output to the interface if the counter is addressed to talk. The counter will not output a measurement until it receives another trigger.

Dump mode measurements use the same output method as normal frequency measurements, except for two differences:

- a. The output format is different (7 characters and EOI (End Or Identify) is sent with the last byte).
- b. The counter cannot be set to HOLD.

### **Extended Function and Diagnostic Results**

Extended Functions and Diagnostics act like measurements in that both continuously cycle. At the end of a cycle, the result is sent to the counter's interface in a "wait until addressed" mode. In this mode, the counter's interface holds the data until read by the controller, and does not allow the data to be overwritten by frequency measurements. During talk only mode, extended function results will not be output. The interface receives the data regardless of whether the counter is addressed to talk or not. An EFUN? query must be sent to the counter for each extended function/diagnostic result desired. Diagnostic failure results are returned in the same way as diagnostic pass results.

### **Other Outputs**

All other outputs must be requested by the controller through a query command. The data is sent to the counter's interface immediately in a "wait until addressed" mode, as described in the preceding paragraph. You can find information about the return format of individual queries in the detailed query descriptions of the HP-IB COMMAND DESCRIPTIONS in this section.

### **Numeric Output Format**

All frequency measurements (except DUMP mode measurements), key code responses to the KEY? query, and error number responses to the ERR? query, are returned in scientific notation. The returned data always contains 24 characters arranged in the format shown in *Figure 4-6*.

Variable number of spaces (N spaces) (at least 1 space)  
 Sign: "-" if negative, or <sp> if positive  
 One digit  
 Decimal point  
 Variable number of digits (K digits)  
 E ±sign  
 Two exponent digits  
 Carriage return  
 Line feed

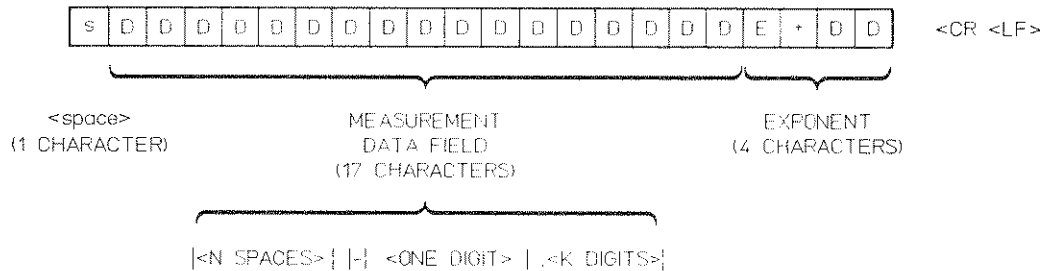

The decimal point is omitted if it is the last character preceding the exponent "E" in the output string. The first digit will be zero only if the data output is zero.

The sign is "-" or <space> (implied positive), and is placed immediately to the left of the first digit of the mantissa. The sign may be preceded by blanks to make the total string length constant. The returned frequency returns all significant digits. The number of significant digits depends on the resolution to which the measurement was made.

Figure 4-6. Numeric Output Format

**MEASUREMENT DATA FIELD**

The data field consists of 17 characters. The number begins with the sign, followed by the digits in descending order of significance. The number is right-justified within the data field. Spaces are inserted in front of the sign to keep the number of characters in the string constant.

**EXPONENT**

The exponent is always two digits, and is preceded by the symbol "E" and a "+" or "-" sign. Hertz units are implied except for PWID, OFFT, and PRI.

**TYPICAL OUTPUT STRINGS**

The example string at the top of Figure 4-7 shows the typical output for an AUTO mode measurement of 19.412 530 789 GHz. A carriage return and line feed always follow the output string.

The example string at the bottom of *Figure 4-7* shows the output returned during an overflow (math result is out of bounds) or if the counter cannot acquire the input signal. (Dump mode is an exception; refer to the description of the DUMP command in the HP-IB COMMAND DESCRIPTIONS in this manual section for additional information.)

*Figure 4-7.*  
Typical Output Strings

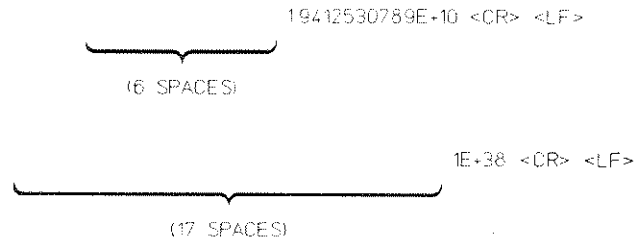

### Query Output Format

Output formats for the HP 5361B query commands vary depending on the particular query. For detailed information about a given query, refer to the individual query descriptions in the HP-IB COMMAND DESCRIPTIONS of this manual section.

### ERROR HANDLING

Certain conditions will cause an error in the HP 5361B. When an error occurs, normal measurement operation is suspended until the error is cleared. The counter continues to process all HP-IB commands while in the error state.

You can clear errors by sending a Device Clear, Selected Device Clear, INIT, RESET, or CLR commands, or by pressing the RESET/LOCAL key. Pressing the RESET/LOCAL key also returns the counter to local operation.

#### NOTE

---

*The INIT Command will reset all internal counter conditions to default status.*

---

You can read error numbers via the bus by sending the ERR? query command. After receiving the ERR? query, the counter sends the error message to the controller, and remains in the error state. For example, the following command strings are required to transmit the error number to the controller:

OUTPUT 714;"ERR?"

ENTER 714;X\$

DISP X\$

The status byte contains an error bit to flag an error condition. When an error condition occurs, the set flag reflects the message displayed on the counter's front panel. The error flag is cleared when the error is cleared, as described above. Note that there is a slight delay between sending the INIT command and the clearing of the status byte flag. If a serial poll is performed during this time, the status byte still shows an error.

## HP-IB COMMAND DESCRIPTIONS

The following paragraphs describe each of the HP-IB commands for the HP 5361B. Each program message and query is listed in alphabetic order. Syntax diagrams for the HP 5361B commands are shown with each explanation.

All query commands return data to the controller. Each description of a query includes information on the output format resulting from a given query.

### AUTO - Automatic Acquisition Mode



The AUTO program message has the same effect as the AUTO key on the front panel (i.e., selects INPUT 1, automatic acquisition mode). The current measurement cycle is aborted.

**AVER -  
Average  
Measurement  
Modifier**

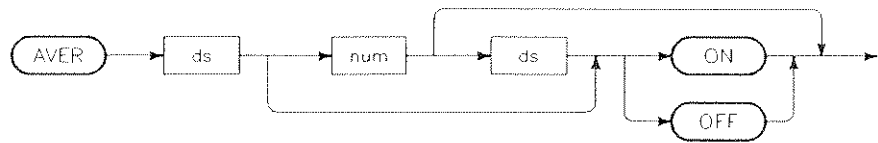

This command is valid only during PWID, OFFT, PRF, and PRI measurements. The AVER program message has the same effect as the RESOLUTION key on the front panel when pressed either alone or along with the SET/ENTER and 0 thru 9 keys during pulse envelope measurements. The measurement cycle is averaged according to the current or new average value that has just been entered. The maximum parameter value is 9,999.

**CHIRP -  
Chirp Mode**

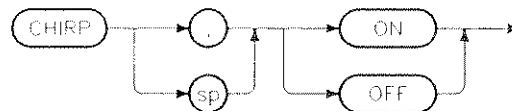

The CHIRP program message performs the same function as EFUN 96. To turn on Chirp mode, send CHIRP, ON over the bus. To return to normal measurement mode, send CHIRP, OFF.

**CLR -  
Instrument Clear**



The CLR program message performs the same function as the Device Clear message: the current measurement is aborted, errors are cleared, input and output buffers are cleared, and any partially entered key sequence or HP-IB command is aborted.

**DATAPTS -  
Data Points**

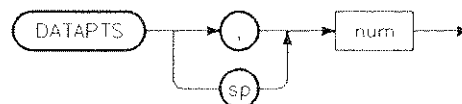

The DATAPTS program message performs the same task as EFUN 87. It sets the number of steps during profiling. When this command is sent, TSTART and TFINAL are cleared (EFUN 81 and EFUN 82 are turned off).

To set the number of steps to 35, send the command string DATAPTS,35 or DATAPTS 35. A maximum of 2 digits is allowed and the maximum number of steps is 99.

This command operates with the commands ESTART and EDELTA to specify how the profiling is to be done. The default value of 0 is loaded during power-up, after the INIT command, or after the SET/ENTER, RESET/LOCAL key sequence.

### DISPLAY - Display Message/Conceal Message

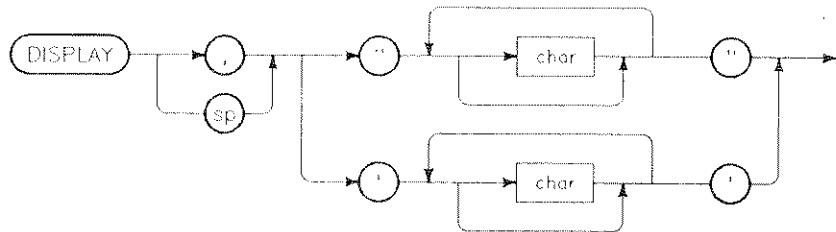

The DISPLAY program message allows a string of up to 24 uppercase letters, numbers, or punctuation to be displayed on the front panel Liquid Crystal Display (LCD). Up to 48 characters are accepted without error, but only the first 24 characters are displayed; the remainder of the string is ignored. The string is left-justified in the display portion of the LCD. Refer to *Table 3-2* in Section 3 for a listing of ASCII codes and corresponding LCD readout displays.

When composing messages for display, you should remember the following considerations:

- a. Embedded string delimiters are not allowed.
- b. Display of a single quotation mark requires the string to be enclosed by double quotation marks.
- c. Display of a double quotation mark requires the string to be enclosed by single quotation marks.
- d. Embedded spaces, commas, and semicolons are allowed.
- e. Each displayed period is part of the character to its left, so periods are not counted in the 24-character limit.
- f. Extra places are filled with blanks.

You can turn off the message and return to normal display by sending a null (empty) string or the INIT command. To blank the display, send a single blank (" ").

The DISPLAY message supersedes all other messages when enabled, thus providing "display concealment" (equivalent to Diagnostic 99 - Display Lockout). No measurements or error message will be displayed while the remote string is active. If you set the counter to local mode (RESET/LOCAL key), the remote message continues to be displayed. To return to normal measurement display, press the special key sequence 7, 4, 0, RESET/LOCAL, momentarily disconnect ac power from the instrument, or use one of the previously mentioned HP-IB commands.

**DUMP -  
Take Fastest  
Measurements**

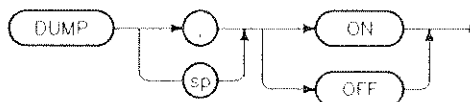

The DUMP program message provides faster reading capability. Refer to *Table A-1* in the appendix A specifications for measurement rates in CW AUTO, CW MANUAL, PULSE AUTO, and PULSE MANUAL. When DUMP is on, the message "DUMPING - - -" is displayed on the front panel. The annunciators and display are not updated. The display will blank after 10 minutes. After DUMP is turned off, the display functions normally. Serial poll status is not updated while in DUMP mode.

The format of the frequency returned in DUMP mode is optimized for speed. The data format is a 7-character numeric ASCII string, with no spaces or decimal points, as follows:

GGMMMkk ^ EOI

- where G = gigaHertz
- M = megaHertz
- k = kiloHertz
- EOI = End Or Identify  
(sent with last digit as message terminator)

Leading zeros are not blanked. The returned value must be multiplied by 10 kHz to get the frequency value in Hertz.



## EDELTA - Event Delta

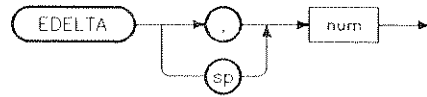

The EDELTA program message performs the same task as EFUN 89. It sets the delta events for profiling. When this command is sent, TSTART and TFINAL are cleared (EFUN 81 and EFUN 82 are turned off).

To set the delta events to 34, send the command string EDELTA,34 or EDELTA 34. A maximum of 6 digits is allowed with the maximum delta events equal to 999999.

This command operates with the commands DATAPTS and ESTART to specify how the profiling is to be done. The default value of 0 is loaded during power-up, after the INIT command or after the SET/ENTER, RESET/LOCAL key sequence.

## EFUN - Extended Function

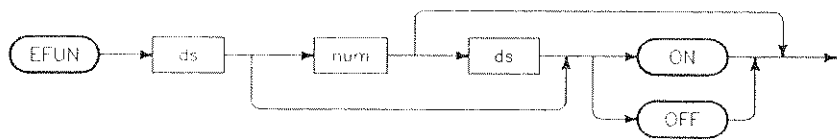

The EFUN program message can be used to set up most of the extended functions over the HP-IB. All functions except 1, 41–43, and 80 are available over the bus. Some functions return data over the bus; others (primarily diagnostic) may require an oscilloscope or additional equipment. To get an extended function result from the counter, you must send the EFUN? query.

### NOTE:

*Extended function failures are not treated as errors (i.e., the error bit in the serial poll is not set by a failed function).*

**NOTE:**

Two extended functions cannot be exited using the EFUN,OFF command. Function 98 (Keyboard Lockout) and 99 (Display Lockout) can be cleared by setting the POWER switch to STBY or by sending the INIT (Initialize Instrument) command.

**EFUNPARAM -  
Extended Function  
Parameter**

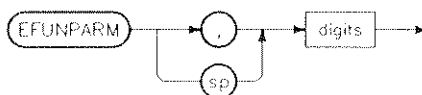

The EFUNPARAM program message is used to send the parameter required by extended functions 51, 81, 82, 87, 88, 89, 90, 91, 92, 95, and 97 after the EFUN program message is sent. As many EFUNPARAM program messages as necessary can be entered immediately after Diagnostics 51, 81, 82, 87, 88, 89, 90, 91, 92, 95, and 97 are enabled.

**EFUN? -  
Send Extended  
Function Result**



The EFUN? query returns the current extended function result to the controller. The data returned consists of 24 ASCII characters arranged in a format similar to the front panel display that would appear for that function in local mode (except that no decimals are sent over the bus). Some of the results include measurements, such as the IF result in extended function 2. These measurements can be extracted from the pass/fail result by controller software.

**ERR? -  
Send Error Number**



The ERR? query causes the counter to return the current error number. If there is no error, the number returned is "0"; otherwise, the error number is returned. The output format is that described in Numeric Output Format earlier in this manual section. The four 5361B error types are listed below and discussed on page 2-88/89.

Error 1:	HP-IB NOT IN	1 ERROR
Error 2:	I/O	2 ERROR
Error 3:	OUT OF RANGE	3 ERROR
Error 4:	SYNTAX	4 ERROR

### ESTART - Event Start

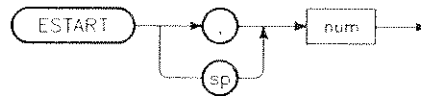

The ESTART program message performs the same task as EFUN 88. It sets the start event for profiling. When this command is sent, TSTART and TFINAL are cleared (EFUN 81 and EFUN 82 are turned off).

To set the start event to 213, send the command string ESTART,213 or ESTART 213. A maximum of 6 digits is allowed with the maximum start event equal to 999999.

This command operates with the commands DATAPTS and EDELTA to specify how the profiling is to be done. The default value of 0 is loaded during power-up, after the INIT command, or after the SET/ENTER, RESET/LOCAL key sequence.

### FINE - Fine/Coarse Data

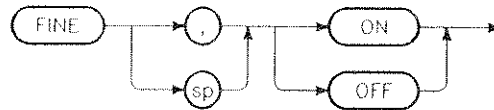

The FINE program message performs the same task as EFUN 83. It selects fine or coarse data for profiling. When the command string FINE,ON or FINE ON is sent, fine data is selected (approximately 50 data points used during profiling). When the command string FINE,OFF or FINE OFF is sent, coarse data is selected (approximately 10 data points used during profiling).

This command operates together with the TSTART and TFINAL commands to specify how the profiling is to be done. The default value of FINE,ON is loaded during full power-up, after the INIT command or after the SET/ENTER RESET/LOCAL key sequence. The data state (fine or coarse) is stored in the standby RAM before power-off.

**FMRATE -  
FM Rate/Track**

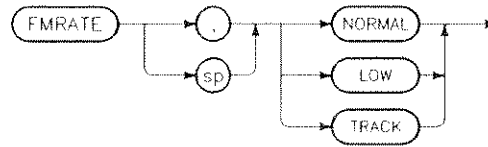

The FMRATE program message sets the FM rate/track function of the counter to one of three settings: NORMAL (normal FM rate), LOW (low FM rate), and TRACK (fast acquisition). For information about the FM rate/track function, refer to the operating procedures in Section 2 of this manual.

**FREQ -  
Frequency**



The FREQ program message has the same effect as the FREQUENCY key on the front panel (selects Frequency measurement for Pulse/CW signals). The current measurement cycle is aborted.

**FREQBAND? -  
Send Frequency Band  
(Option 040 Only)**

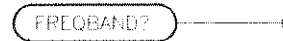

The FREQBAND? query is available only with Option 040. The FREQBAND? query causes the counter to return the current frequency band. It returns "HIGH" if the counter is in the high frequency band, and returns "LOW" if the counter is in the low frequency band.

**FUNC? -  
Send Current  
Pulse/CW Function(s)**



The FUNC? query causes the counter to return the current active pulse/CW function(s). The functions that can be returned for pulse measurements include: PWID, OFFT, PRF, PRI, PULSE, LPRF, GATE, and NPUL ON/OFF (<100 ns pulse mode). The functions that can be returned for CW mode include: FMRATE, FREQ and GATE.

For example, with pulse width and external gate the return would be: PWID, EXT. For pulse frequency with arming and narrow pulse the return would be: PULSE, ARM, NPUL. For CW frequency with a low FM tracking rate the return would be: CW, LOW.

### GATE - Gate Mode

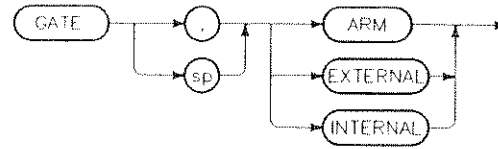

The GATE program message sets the Gate mode function of the counter to one of three settings: Arm, External, or Internal. For information about the Gate mode function, refer to the operating procedures in Section 2 and control/indicator information in Section 3 of this manual.

### GWID - Set Gate Width

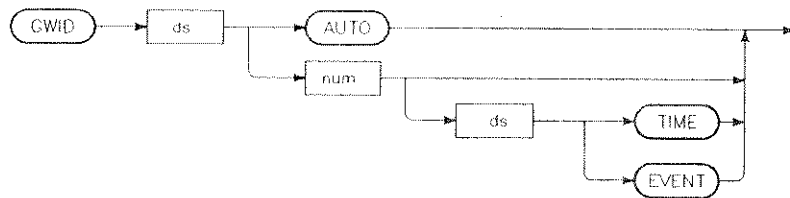

This HP-IB command performs the same tasks as EFUN 90 for time and EFUN 95 for events. GWID sets the gate width in either time or events. You can also return the counter to automatic gate measurement mode by sending GWID,AUTO over the bus.

To set the counter to a gate width of 13.5 micro-seconds, the command string would be GWID,13.5E-6 or GWID,13.5E-6,TIME. If there is no character data sent with GWID (such as TIME), then it is assumed the corresponding number represents time. To set the counter to 45 events the command GWID,45,EVENT would be used.

**HARM? -  
Send Harmonic  
Number**



The HARM? query outputs the harmonic number. This must be sent at the end of the measurement cycle. The output is in pseudo-scientific notation format. For example, if the harmonic number = 61, the output will be 6.1E+1.

**HARMDET -  
Harmonic Number  
Determination**

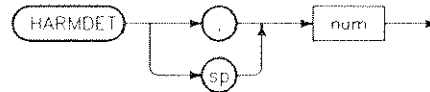

The HARMDET program message allows you to select how often the harmonic number (N) determination occurs during measurements. In local operation, harmonic number determination takes place during every measurement. In remote, the N determination takes place every 10 measurements. The desired number of measurements for N determination is sent as numeric data with the HARMDET command. Determination of N takes place after the chosen number of measurements has occurred.

If the counter is returned to local operation after a HARMDET command is sent, the number of measurements set via the bus is lost; the counter returns to determining N every measurement in local or remote operation.

**HIGHBAND -  
Set High Frequency  
Band (Option 040  
Only)**

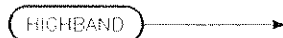

The HIGHBAND program message has the same effect as the front panel key sequence: SET/ENTER, FREQUENCY/PROFILE when the LOWBAND command is active. When HIGHBAND is selected, the frequency band is between 12 GHz and 40 GHz. The annunciator "High Band" is on and the message "HIGHER FREQ BAND" is displayed. This command is disabled when the LOWBAND command is active.

The default state, high frequency band, is loaded during full power-up (after AC power disconnect), after the INIT command, or after the SET/ENTER, RESET/LOCAL key sequence. The frequency band status (low frequency band or high frequency band) is stored in standby RAM before power-off.

### HIGHZ - INPUT 2, 1 M $\Omega$



The HIGHZ program message has the same effect as pressing the 1 M $\Omega$  key on the front panel (i.e., selects INPUT 2, 1 M $\Omega$  input impedance). The current measurement cycle is aborted.

### HIRESOL - High Resolution

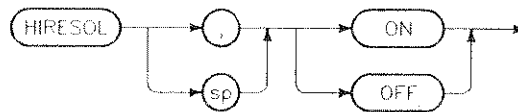

The HIRESOL program message turns the High Resolution function on and off for INPUT 2, 1 M $\Omega$  impedance measurements and INPUT 1 PRF measurements. This function will take precedence over the current resolution setting. The smooth function, if active, takes precedence over the high resolution function for INPUT 2 1 M $\Omega$  impedance measurements.

The higher resolution provided by the high resolution function depends on the input frequency, as shown in *Table 2-4* (where  $F_{in}$ =input frequency to INPUT 2).

### ID? - Send Identity



The ID? query causes the instrument to return a 7-character string containing the instrument model number "HP 5361B".

**IFPER? -  
Send IF Periods  
Per Step**



The IFPER? query outputs the same value that appears in the text portion of the plot titled "IF periods per step =". This command must be sent at the end of the profiling cycle. The output is in pseudo-scientific notation format. For example, if the IF periods per step = 7, the output will be 7E+0.

**INIT -  
Initialize Instrument**



The INIT program message sets the instrument to a state identical to the initial power-on state, except that the HP-IB interface is unaffected. This message clears errors, clears input and output buffers, turns off dump and sleep modes, and turns off keyboard and display lockouts (Diagnostics 98 and 99), if they are active. The INIT message is the only command (other than DUMP OFF) that should be sent to the instrument when dump mode is enabled; sending any other command will give unpredictable results. The INIT command must be followed by a Wait statement of at least 1.1 seconds prior to any further commands to the instrument.

**NOTE:**

---

*Because the RESET, CLR, and INIT commands clear the input buffers, these commands should be sent so that no new input is bussed until the last command is processed. This can be done by sending the command by itself with no other commands in that program message, or by placing the RESET, CLR, or INIT command at the end of a string of commands, as shown in the two examples below:*

```
OUTPUT 714;"RESET"
OUTPUT 714;"OFFSET,ON;AUTO;RESET"
```

---

**KEY? -  
Send Number of Last  
Key Pressed**



The KEY? query causes the instrument to return a number corresponding to the last key pressed, according to the list of



key codes shown in Table 4-9. The format of the returned number is described in Numeric Output Format earlier in this manual section.

Table 4-9. Key Codes (KEY? query)

KEY CODE	KEY NAME	KEY CODE	KEY NAME
0	No Key	11	EXTENDED FUNCTIONS/1
1	RESET/LOCAL	12	GATE MODE/4
2	FREQ/PROFILE/GHz/ms	13	TRIGGER/.
3	PRF-PRI/KHz/ns	14	SELF CHECK-CAL/8
4	PWIDTH-OFFTIME/MHz/ $\mu$ s	15	FM RATE/TRACK/2
5	SET/ENTER	16	HP-IB ADDRESS/5
6	OFFSET/LST VAL	17	MANUAL/ $\pm$
7	SMOOTH/DEC $\leftarrow$	18	50 OHM/9
8	SCALE/INC $\rightarrow$	19	AUTO/3
9	SAMPLE RATE/0	20	1M OHM/6
10	RESOLUTION/7		

### LOWBAND - Set Low Frequency Band (Option 040 Only)

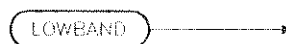

The LOWBAND program message has the same effect as the front panel SET/ENTER, FREQUENCY/PROFILE key sequence when the HIGHBAND command is active. When the LOWBAND command is selected, the frequency band is between 0.5 GHz and 29 GHz. The annunciator "High Band" is OFF and the message "LOWER FREQ BAND" is displayed.

The default, high frequency band, is loaded during full power-up (after ac power disconnect), after the INIT command, or after the SET/ENTER, RESET/LOCAL key sequence. The frequency band status (low frequency band or high frequency band) is stored in standby RAM before power-off.

### LOWZ - INPUT 2, 50 $\Omega$



The LOWZ program message has the same effect as pressing the front panel 50 $\Omega$  key (i.e., selects INPUT 2, 50 $\Omega$  input impedance). The current measurement cycle is aborted.

**LO? -  
Send LO Frequency**



The LO? query outputs the LO frequency in Hz. The command must be sent at the end of the measurement cycle. The output is in pseudo-scientific notation format. For example, if the LO frequency = 334.3 MHz, the HP-IB output will be 3.34300000E+8.

**LPRF-  
Low Pulse Repetition  
Frequency**

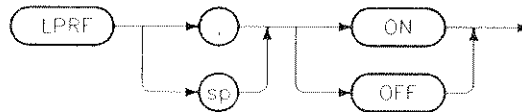

The LPRF ON program message has the same effect as turning on the <50 Hz PRF front panel function while in pulse mode. This function must be preceded by entry into the manual mode of operation.

**MANUAL -  
INPUT 1, Manual  
Mode**

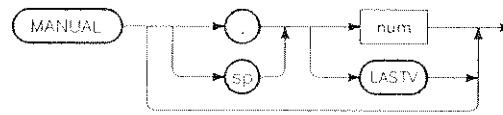

The MANUAL program message has the same effect as pressing the front panel MANUAL key (i.e., selects INPUT 1, manual mode). A manual center frequency parameter can be specified, in Hertz. If you do not specify a frequency or if you send the LASTV parameter, the last measurement is used as the manual center frequency. The current measurement cycle is aborted.

**MMOD -  
Set Measurement  
Mode**

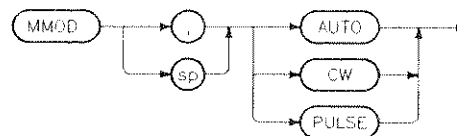

This HP-IB command performs the same task as EFUN 92. MMOD allows the counter to either: automatically determine whether the signal is CW or Pulse, make only CW measurements, or make only Pulse measurements. To set the counter to measure only CW, send MMOD,CW; to measure

only Pulse, send MMOD,PULSE. To return to the automatic choice between CW and Pulse, send MMOD,AUTO.

**NPUL -  
Narrow Pulse Mode**

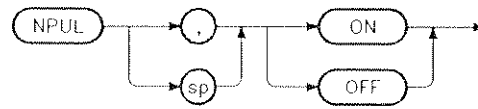

This HP-IB command performs the same task as EFUN 93. To turn on the Narrow Pulse (less than 100 nanosecond) measurement mode, send NPUL,ON over the bus. To return to normal measurement mode, send NPUL,OFF

**OFFSET -  
Offset**

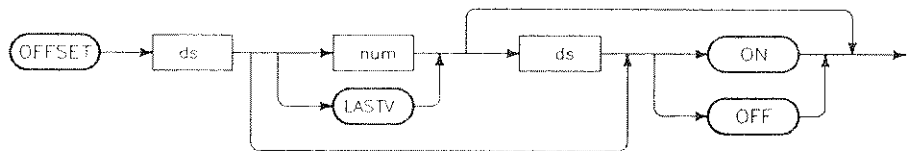

The OFFSET program message is used to turn the offset function on and off, and to set the offset value. Sending the OFFSET command with a value parameter automatically turns on the offset function; in this case, sending "ON" or "OFF" is not required. The parameter can be positive (added to the measured value) or negative (subtracted from the measured value).

If "LASTV" is sent with the OFFSET command, the last measured value, negated, becomes the offset. For example, if the last measured frequency was 10 MHz, the offset value after sending "OFFSET, LASTV" will be: -10 000 000. All values are entered in hertz/time units.

**OFFT -  
Pulse Off Time**



The OFFT program message has the same effect as pressing the OFFTIME key on the front panel (selects Pulse Off Time measurement for Pulse signals). The current measurement cycle is aborted.

**OVEN? -  
Send Oven Status**



The OVEN? query causes the instrument to return its oven status: WARM (if ready) or COLD. If neither of the oven oscillator options (Option 001 or 010) is installed, the WARM message is returned.

Oven status should be checked to ensure that valid measurements can be made when an oven oscillator is installed. Immediately after ac power is connected to the instrument, the oven is cold. The instrument responds to the OVEN? query by returning the COLD message. After the oven is stabilized at its correct temperature, the message returned will be WARM.

**PAVER -  
Pulse Averaging**

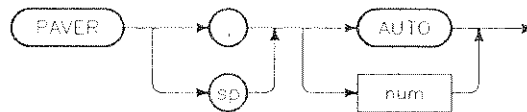

This HP-IB command performs the same task as EFUN 91. PAVER sets the number of averages used in measuring the pulse carrier frequency. This is different from the AVER command used for the pulse envelope functions (pw, offtime, prf and pri). PAVER is used only for pulse carrier frequency measurements. (Refer to page 2-75 for frequency averaging information.)

When a value is set for PAVER, the counter will not calculate the number of averages needed to get a requested resolution. The syntax for PAVER to set 12 averages is, PAVER,12. You can return the counter to its automatic average number algorithm by sending PAVER,AUTO. The counter now averages as many measurements as needed for a requested resolution. If the total accumulated gate time for a measurement exceeds 20 seconds, the counter may display zero. Total gate time equals programmed width × number of averages.

**PRF -  
Pulse Repetition  
Frequency**



The PRF program message has the same effect as pressing the PRF key on the front panel (selects Pulse Repetition Frequency

measurement for Pulse signals). The current measurement cycle is aborted.

### **PRI - Pulse Repetition Interval**



The PRI program message has the same effect as pressing the PRI key on the front panel (selects Pulse Repetition Interval measurement for Pulse signals). The current measurement cycle is aborted.

### **PROF - Profile Frequency**



The PROF program message sets the counter to profiling mode. It also sets the counter to output the table to an instrument controller. The PROF command does not affect the currently active acquisition mode whether AUTO or MANUAL for INPUT 1. If the counter is in either of the INPUT 2 modes, it is changed to the INPUT 1 AUTO mode after this command is sent. The table of time vs frequency will be sent to the instrument controller via the HP-IB, see example program #12 on page 4-54.

During the profile measurement process, the message "PROFILING- - -" is displayed. When the first profile data point of the table becomes available, the message "OUTPUT TABLE VIA HPIB- - -" is displayed. Data is sent using the "Wait To Send" mode. Each piece of data (time and frequency together on one line) is not overwritten by another until it is read by the instrument controller.

Profile data is obtained by multiple reads from the counter. Each read consists of time (in nanosecond) and profile frequency (in Hz) separated by spaces (the format is the same as the one used for the printer). The end of the table is indicated by the message "EOT". At the end of the profiling cycle, the average frequency is displayed.

A convenient way to obtain the table is to first set the counter's sample rate to "HOLD". Then send the TRG command after all necessary parameters are set up. Tabular data is collected by multiple reads from the counter until "EOT" is received. If you want the average frequency, execute one more read from the counter after the "EOT" message. Sending another TRG

command initiates another frequency profile measurement and provides a new table.

The profiling mode is turned OFF during full power-up, after the INIT command or after the SET/ENTER, RESET/LOCAL key sequence. The profile mode is stored in the standby RAM before power-off.

The counter can do frequency profiling without having to send the TSTART, TFINAL, FINE ON/OFF, DATAPTS, ESTART or EDELTA commands. If these commands contain the default values, the counter profiles between the beginning and end of the pulse using approximately 50 data points.

**PROFAVG? -  
Send Profile Number  
Of Averages**



The PROFAVG? query outputs the same number which appears in the text portion of the plot alongside the row titled "Number of averages =". The command must be sent at the end of the profiling cycle. The output is in pseudo-scientific notation format. For example, if the number of averages=3000, the output is be 3.000E+3.

If the PAVER program message is used to set the number of averages to a non-zero value, the PROFAVG? query outputs the same number set by the PAVER command. If the PAVER program message sets the number of averages to 0, then the PROFAVG? query outputs a number based upon the current measurement resolution and width in time.

**PROFTIME -  
Profile Time Data**



The PROFTIME program message performs the same measurement as the PROF command except that the table consists of a list of time values. These time values (ns) correspond to each step accumulated over averaging. This time data can be used, for example, to make phase deviation measurements. (Refer to appendix D.)

**PWID -  
Pulse Width**



The PWID program message has the same effect as pressing the P WIDTH key on the front panel (selects Pulse Width measurement for Pulse signals). The current measurement cycle is aborted.

**REF? -  
Send Time Base  
Reference Status**



The REF? query causes the instrument to return its reference status. This query is most useful as a check that the instrument is properly connected to an external source. If an external source (1, 2, 5, or 10 MHz) is connected to the EXTERNAL IN connector on the rear panel, an EXT message is returned. If no external source is connected, the instrument is using its internal 10 MHz timebase reference, and the INT message is returned.

**RESET -  
Restart Measurement**



The RESET program message performs the same function as the front panel RESET/LOCAL key when the instrument is in local mode: the current measurement is aborted, errors are cleared, input and output buffers are cleared, and any partially entered key sequence or HP-IB command is aborted. In addition, the extended function mode, if active, is exited.

**RESOL -  
Resolution**

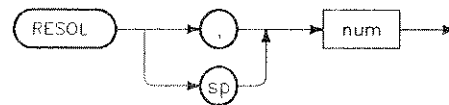

The RESOL program message sets the resolution to values ranging from 1 Hz to 1 MHz, in decade steps. To set a resolution, send an integer with the RESOL header; non-integer data will be rounded. The numeric data codes corresponding to the resolution settings are listed below:

Numeric Data	Resolution
0 . . . . .	1 Hz
1 . . . . .	10 Hz
2 . . . . .	100 Hz
3 . . . . .	.1 kHz
4 . . . . .	10 kHz
5 . . . . .	100 kHz
6 . . . . .	1 MHz

**REV? -  
Send Firmware  
Revision Date Code**



The REV? query causes the instrument to return a data code for the last firmware revision as a 4-digit ASCII string.

**SAMPLE -  
Sample Rate**

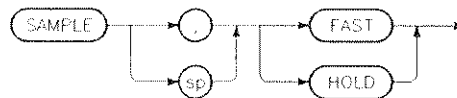

The SAMPLE program message sets one of two sample rates: the FAST parameter causes the instrument to repeat measurements as quickly as possible. When the HOLD parameter is sent, a new measurement starts only after a TRIGGER or TRG program message is sent, or in response to a Group Execute Trigger (GET) on the bus.

**SCALE -  
Scale**

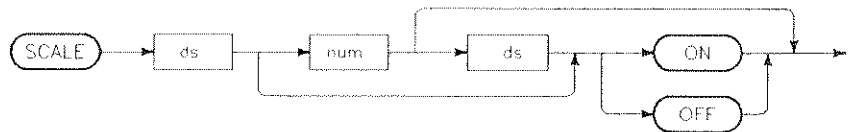

The SCALE program message is used to turn the scale function on and off, and set the scale value. If you send the SCALE header with a numeric value, the scale function automatically turns on (the ON parameter is not required).



**SER? -  
Send Serial Number**



The SER? query is intended for Modular Automatic Test Equipment (MATE) compatibility. The instrument cannot return its actual serial number. Instead, the instrument returns a number in the correct format, as shown below:

ddddA00000

-where "dddd" is the firmware revision date, "A" is the country of origin (A = USA), and the number is zero ("00000").

**SET -  
Accept Instrument  
Setup**

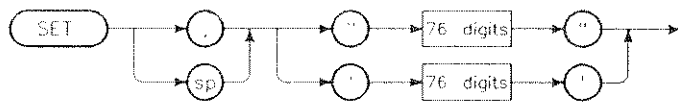

The SET program message sets up the instrument according to the data sent. The data sent is determined by previous instrument setup data saved using the SET? query. Different instrument configurations can be saved, then restored using the SET and SET? commands. Measurement results are not saved. For information about using the SET? query to save instrument setup data, refer to the following SET? query command description.

**SET? -  
Send Instrument  
Setup**



The SET? query causes the instrument to return an ASCII-encoded binary string specifying the current instrument setup. A 38-byte block of data from the microprocessor's internal RAM is sent to the controller. This block of binary bytes is converted to a 76-byte string of hexadecimal characters. The string is not enclosed in quotes. The data returned by the SET? query, if sent back to the instrument using the SET program message, configures the instrument setup.

**SETIF -  
Set IF For Manual  
Frequency**

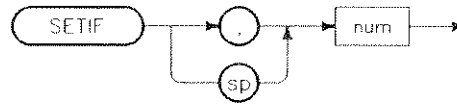

The SETIF program message performs the same task as EFUN 97, allowing you to specify the IF in MHz (2 digits only) when setting a manual center frequency. To set the IF to 56 MHz, send the command string SETIF,56 or SETIF 56. A maximum of 2 digits is allowed (the maximum IF value allowed is 99 MHz).

**SIDEBAND? -  
Send Sideband  
Position**



The SIDEBAND? query outputs the sideband position. The query must be sent at the end of the measurement cycle. The output is "LOWER" if in lower sideband, "UPPER" if in upper sideband.

**SLEEP -  
Low Emissions Mode**

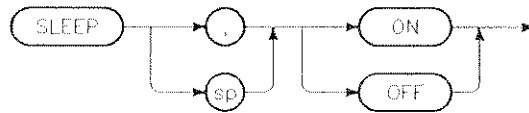

The SLEEP program message disables the high frequency input circuit (INPUT 1) to minimize emissions for the microwave input circuits. The SLEEP,ON command turns off power to the A12 Microwave Assembly. This command is useful when several instruments are connected to one signal, and the HP 5361B is temporarily not used for signal measurements. INPUT 1 measurements cannot be made when the sleep function is on. To turn the INPUT 1 circuit back on, send a SLEEP,OFF command to the instrument.

**SMOOTH -  
Smooth**

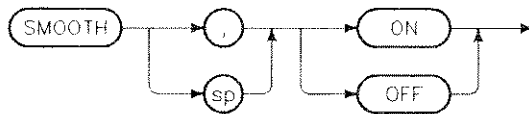

The SMOOTH program message turns the smooth function on and off. The smooth algorithm and measurement cycle are restarted.

## SRQMASK - Service Request Mask

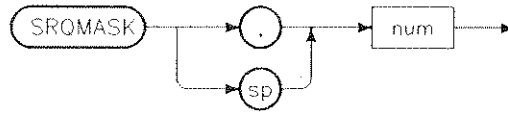

The SRQMASK program message is used to set the service request mask to enable selected status conditions to generate a service request (SRQ). If you set a given bit in the service request mask to "1" and a status condition occurs to set the corresponding bit in the status byte to "1", that status condition generates a service request mask. To set the mask, send "SRQMASK,n", where "n" is the decimal equivalent to the binary-weighted value of the desired condition(s), as shown below:

Binary	Decimal	Condition
0000 0000	0	No SRQ conditions enabled
0000 0001	1	Data Ready
0000 0010	2	Measurement Complete
0000 0100	4	Error
0000 1000	8	Level
0001 0000	16	Local
00X0 0000	32	(don't care)
0X00 0000	64	(don't care)
X000 0000	128	(don't care)

Conditions can be enabled singly or in any combination desired. For example, sending "SRQMASK,6" will cause a service request if either an error occurs or a measurement is completed. Any number from 0 to 255 can be sent. For more information about the service request mask, refer to CHECKING INSTRUMENT STATUS in this manual section.

## TEST? - Send Self Check Results



The TEST? query has an effect similar to pressing the front panel SELF CHECK key, starting an automatic sequence of diagnostic subroutines to test the counter's measurement circuits. Unlike the front panel self check, however, the counter exits the TEST? query self check immediately after the first failure. (Refer to "What to Do If There is a Problem" in Section 2 for more information about the front panel self check.)

After the self check is performed, a pass or fail result is returned to the controller. The result consists of 24 ASCII characters. The format is similar to the front panel display for

a local self check, except that no decimal points are sent over the bus.

**TFINAL -  
Set Profile Stop  
Time**

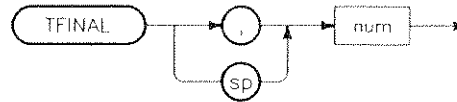

The TFINAL program message performs the same task as EFUN 82. It sets the stop time for profiling. When this command is sent, ESTART, EDELTA and DATAPTS are cleared. (EFUN 87, EFUN 88 and EFUN 89 will be turned off).

To set a stop time of 13  $\mu$ s, send the command string TFINAL,1.3E-5 or TFINAL 1.3E-5. Maximum allowed time is 9.999999 ms.

This command operates with the TSTART and FINE ON/OFF commands to specify how the profiling is done. The default value of 0 is loaded during power-up (full power-up or power-up from standby), after the INIT command, or after the SET/ENTER, RESET/LOCAL key sequence.

The default value of 0 uses the pulse width or the external gate width to determine the stop time, as long as ESTART, EDELTA and DATAPTS are not being used to control the profile.

**TRG, TRIGGER -  
Trigger**

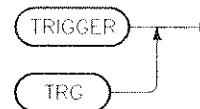

The TRIGGER or TRG program message has the same effect as the front panel TRIGGER key. If the instrument sample rate is set to HOLD when the TRIGGER command is sent, a new measurement is started. If the sample rate is not set to HOLD, the current measurement is aborted and a new one is started.

## TSTART - Set Profile Start Time

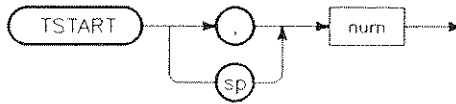

The TSTART program message performs the same task as EFUN 81. It sets the start time for profiling. When this command is sent, ESTART, EDELTA and DATAPTS commands are cleared. (EFUN 87, EFUN 88 and EFUN 89 are turned off).

To set a start time of 13ns, send the command string TSTART,1.3E-8 or TSTART 1.3E-8. The maximum time allowed is 9.999999 ms.

This command operates with the TFINAL and FINE ON/OFF commands to specify how the profiling is done. The default value of 0 is loaded during power-up (full power-up or power-up from standby), after the INIT command, or after the SET/ENTER, RESET/LOCAL key sequence.

## PROGRAMMING EXAMPLES

You can learn to program the counter more easily through the use of tried and tested HP-IB example programs. The following pages provide eleven programs for the HP 5361B. The examples shown are written in Series 200/300 BASIC. CW Frequency measurement is covered first, followed by Pulse measurement.

### Example Program #1 (Frequency Measurement):

```
100 DIM F$(24)
110 REMOTE 714
120 OUTPUT 714;"SAMPLE,FAST"
130 FOR K=1 TO 10
140 ENTER 714;F$
150 PRINT K;F$
160 NEXT K
170 LOCAL 714
180 END
```

This program sets the 5361B for remote operation, and sets the sample rate to take measurements as fast as possible. Ten measurements are taken; after each measurement, the measurement data is entered into a string and the string content is printed out by the controller. After 10 measurements have been taken, the counter returns to local operation.

### Example Program #2 (Frequency Measurement With Trigger):

```
10 DIM F$(24)
20 REMOTE 714
30 OUTPUT 714;"SAMPLE, HOLD"
40 FOR K=1 TO 10
50 OUTPUT 714;"TRIGGER"
60 ENTER 714;F$
70 PRINT K;F$
80 NEXT K
90 LOCAL 714
100 END
```

This program sets the 5361B to remote operation, and sets the sample rate to wait until triggered. The counter is triggered 10 times; at each measurement, the measurement data is entered into a string, and the string content is printed out by the controller. After 10 triggered measurements, the counter is returned to local operation.

### Example Program #3 (Timebase Verification):

```
10 DIM D$(24)
20 REMOTE 714
30 OUTPUT 714;"EFUN,10"
40 OUTPUT 714;"EFUN?"
50 ENTER 714;D$
60 PRINT D$
70 OUTPUT 714;"EFUN,OFF"
80 LOCAL 714
90 END
```

This program sets the 5361B for remote operation, and turns on extended function 10 (Timebase Verification). The controller sends a query to the counter, and the function result is entered into a string. The controller prints the string content, turns the function off, and then returns the counter to local operation.

**Example Program #4 (Display Message):**

```

10 DIM D$[24]
20 REMOTE 714
30 D$="REMOTE MESSAGE"
40 OUTPUT 714;"DISPLAY,""&D$&"'"
50 WAIT 2
60 OUTPUT 714;"DISPLAY,"'"
70 LOCAL 714
80 END

```

This program sets the 5361B to remote, and sets up a string containing a 14-character message. The controller sends the DISPLAY command to the counter, with the message to be displayed. The message is displayed on the counter's front panel Liquid Crystal Display for two seconds, after which a blank is sent to the counter to clear the display. The counter then returns to local. Note the use of double and single quotes in the message to be displayed. The counter requires that data sent with the DISPLAY command be delimited by quotes. In this case, the data (D\$) is delimited by single quotes. In line 40 of the BASIC program three strings are joined (using &) to form the command to the counter: "DISPLAY, 'REMOTE MESSAGE'".

**Example Program #5 (Set/Return Status Byte):**

```

10 Mask=4+2
20 REMOTE 714
30 OUTPUT 714;"SRQMASK,";Mask
40 P=SPOLL(714)
50 PRINT P
60 LOCAL 714
70 END

```

This program assigns a decimal value of 6 (4+2) to the variable "Mask". The 5361B is then set to remote, and the SRQMASK command is sent, along with the decimal value. The value of 4+2 enables the Error bit and the Measurement Complete bit in the status byte as conditions to generate an SRQ, if one or both of the conditions occurs. The controller next takes a serial poll of the counter, and assigns the value of the received status byte to the variable "P". The controller prints the status byte contents, and returns the counter to local.

**Example Program #6 (Manual Dump Mode Measurement):**

```
10 DIM F$(100)[7]
20 REMOTE 714
30 OUTPUT 714;"MANUAL,4E+9"
40 OUTPUT 714;"SAMPLE,FAST"
50 OUTPUT 714;"RESOL,4"
60 OUTPUT 714;"OFFSET,OFF"
70 OUTPUT 714;"SCALE,OFF"
80 OUTPUT 714;"SMOOTH,OFF"
90 OUTPUT 714;"DUMP,ON"
100 !
110 FOR K=1 TO 100
120   ENTER 714;F$(K)
130 NEXT K
140 !
150 OUTPUT 714;"DUMP,OFF"
160 FOR K=1 TO 100
170   F=VAL(F$(K))*10000
180   PRINT K,F;"Hz"
190 NEXT K
200 !
210 LOCAL 714
220 END
```

This program sets the 5361B to remote, followed by commands to enable the DUMP mode with the counter set for a Manual measurement: Manual measurement mode is selected (with a chosen center frequency of 4 GHz), sample rate set for the fastest possible measurements, 10 kHz resolution, and all Math functions off. The DUMP mode is then turned on. The controller enters the data from a series of measurements into 100 strings, after which the DUMP mode is turned off. The content of each string is converted into a numeric value, multiplied by 10,000, and printed out by the controller (in Hz units). Finally, the counter returns to local operation.



**Example Program #7****(Frequency Measurement With Trigger/Measurement Complete Report):**

```
10  REMOTE 714
20  OUTPUT 714;"SAMPLE,HOLD"
30  OUTPUT 714;"SRQMASK,2"
40  ON INTR 7 CALL Display
50  ENABLE INTR 7;2
60  I
70  OUTPUT 714;"TRIGGER"
80  FOR K=1 TO 20
90    WAIT .10
100 NEXT K
110 LOCAL 714
120 END
130 I
140 SUB Display
150 DIM F$(24)
160 S=SPOLL(714)
170 PRINT "STATUS = ";S
180 ENTER 714;F$
190 PRINT "Measured";F$;" Hz"
200 ENABLE INTR 7;2
210 SUBEXIT
220 SUBEND
```

This program illustrates the use of interrupts to detect the end of a measurement. The 5361B sample rate is set to HOLD so that a triggered measurement may be made. The Measurement Complete bit of the service request mask is enabled as a condition to cause a service request. The controller is set up to call a subroutine ("Display") to handle the service request interrupt when it occurs. The counter is triggered and begins a measurement. A two second wait loop is executed during which the counter completes the measurement and causes an SRQ interrupt. The Display subroutine is called; this subroutine proceeds to read and print the serial poll status byte and the just completed measurement. The Measurement Complete bit in the status byte is automatically cleared after the serial poll. The subroutine sets up the controller to accept interrupts, and then returns to the main program. When the wait loop is finished, the counter returns to local.

### Example Program #8 (Narrow Pulse/Manual Mode Frequency Measurement):

```

10  !
20  ASSIGN @Counter TO 714
30  Manual_freq=1.28E+10           ! MANUAL FREQUENCY TO BE SET
40  !
50  OUTPUT @Counter;"INIT"         ! PRESET THE COUNTER
60  OUTPUT @Counter;"SAMPLE,HOLD"  ! SET THE COUNTER TO WAIT FOR A TRIGGER
55  WAIT 1.1                       ! WAIT 1.1 SECONDS
70  OUTPUT @Counter;"NPUL,ON"      ! TURN ON THE LESS THAN 100NS MEASUREMENT
80  !                               ! MODE
90  OUTPUT @Counter;"MANUAL",&VAL$(Manual_freq) ! SET THE MANUAL FREQUENCY
100 OUTPUT @Counter;"TRIGGER"      ! START THE MEASUREMENT
110 !
120 ENTER @Counter;Frequency       ! READ THE MEASUREMENT DATA
130 PRINT "THE FREQUENCY IS ",Frequency
140 !
150 OUTPUT @Counter;"PWID"         ! SETUP TO READ THE PULSE WIDTH
160 OUTPUT @Counter;"TRIGGER"      ! START THE MEASUREMENT
170 !
180 ENTER @Counter;Pulse_width     ! READ THE PULSE WIDTH
190 PRINT "THE PULSE WIDTH IS ",Pulse_width
200 !
210 END

```

This program illustrates how to measure the carrier frequency of an 80 nanosecond pulse. The less than 100 ns measurement mode is turned on and the center frequency (CF) must be entered in manual mode. The width of the pulse burst is also measured.

### Example Program #9 (External-Gate Pulse Carrier/PRF Measurement):

```

10  !
20  ASSIGN @Counter TO 714
30  !
40  OUTPUT @Counter;"INIT"         ! PRESET THE COUNTER
50  OUTPUT @Counter;"RESOL,4"      ! SET THE 10KHZ RESOLUTION
55  WAIT 1.1                       ! WAIT 1.1 SECONDS
60  OUTPUT @Counter;"GATE,EXT"     ! SET COUNTER TO MEASURE WITH AN EXTERNAL GATE
70  !
80  ENTER @Counter;Frequency       ! SINCE THE COUNTER IS IN THE "FAST"
90  !                               ! MEASUREMENT MODE, NO NEED TO TRIGGER
100 !                               ! THE COUNTER. THE MEASUREMENT WILL BE READ
110 !                               ! ONCE IT IS COMPLETE.
120 PRINT "THE FREQUENCY IS ",Frequency
130 !
140 OUTPUT @Counter;"PRF"          ! SET THE COUNTER TO MEASURE "PRF". THIS IS
150 !                               ! THE TRUE REPETITION FREQUENCY OF THE SIGNAL,
160 !                               ! NOT THE REPETITION OF THE GATING SIGNAL.
170 !
180 ENTER @Counter;Rep_freq        ! ENTER THE PULSE REPETITION FREQUENCY
190 PRINT "THE PULSE REPETITION FREQUENCY IS ",Rep_freq
200 !
210 END

```

This program first performs a frequency measurement on an externally gated pulse burst and then measures its pulse repetition frequency (PRF). The programmed measurements specify a 10 kHz resolution for the carrier frequency and 1 Hz resolution for the PRF.

**Example Program #10 (Pulse Width/Period (PRI) Average Measurement):**

```

10  !
20  ASSIGN @Counter TO 714
30  !
40  OUTPUT @Counter;"INIT"           ! PRESET THE COUNTER
50  OUTPUT @Counter;"SAMPLE,HOLD"    ! HAVE COUNTER WAIT FOR OUR SIGNAL TO
60  !                               ! BEGIN THE MEASUREMENT
70  OUTPUT @Counter;"AVER,250;PWID"  ! SET THE COUNTER TO AVERAGE 250
80  !                               ! MEASUREMENTS. ALSO, WE WANT THE COUNTER
90  !                               ! TO MEASURE THE PULSE WIDTH
100 OUTPUT @Counter;"TRIGGER"        ! START THE MEASUREMENT
110 !
120 ENTER @Counter;Pulse_width      ! READ THE RESULTS OF THE MEASUREMENT
130 PRINT "THE PULSE WIDTH IS ",Pulse_width
140 !
150 OUTPUT @Counter;"PRI"           ! SET THE COUNTER UP TO MEASURE THE
160 !                               ! PULSE REPETITION INTERVAL (PULSE
170 !                               ! PERIOD)
180 OUTPUT @Counter;"TRIGGER"        ! START THE MEASUREMENT
190 !
200 ENTER @Counter;Pulse_period
210 PRINT "THE PULSE PERIOD IS ",Pulse_period
220 !
230 END

```

This program first measures the Pulse Width and then the Pulse Period (PRI) of the input signal. Each output measurement is the average of 250 separate measurement samples and is triggered via program commands.

**Example Program #11 (Set Gate Width/Trigger Frequency Measurement):**

```

10  !
20  ASSIGN @Counter TO 714
30  !
40  OUTPUT @Counter;"INIT"           ! PRESET THE COUNTER
45  WAIT 1.1                         ! WAIT 1.1 SECONDS
50  OUTPUT @Counter;"SAMPLE,HOLD"    ! SET COUNTER TO WAIT FOR A TRIGGER
60  OUTPUT @Counter;"GWID,23.5E-6,TIME" ! SET THE COUNTER TO RECEIVE THE GATE
70  !                               ! WIDTH OF 23.5 MICROSECONDS
80  !
90  !
100 TRIGGER @Counter                 ! USE A GROUP EXECUTE TRIGGER TO TAKE
110 !                               ! THE MEASUREMENT
120 !
130 ENTER @Counter;Frequency        ! READ THE DATA
140 PRINT "THE FREQUENCY IS ",Frequency
150 !
160 END

```

This program first sets the gate width and then makes a frequency measurement. A group execute trigger is used to trigger the counter instead of the trigger command.

**Example Program #12 (Frequency Profiling Data):**

```

10  ! Example Program #12: Frequency Profiling Data
20  !
30  C$=CHR$(255)&"X"                ! * Clear the screen.
40  OUTPUT 2 USING "#,K";C$
50  Counter=714                      ! * HPIB: Counter = 14.
60  REMOTE Counter                   ! * Put the counter in remote.
70  !
80  DIM Timez$(100)[48]              ! * Time vs freq data.
90  OUTPUT Counter;"INIT"            ! * Initialize the counter.
100 WAIT 1.2                          ! * This is the minimum delay time
110                                  ! * for init to complete.
120 OUTPUT Counter;"RESOL,0"
130 OUTPUT Counter;"SAMPLE HOLD"
140 PRINT ""
150 PRINT "          PROFILING IN PROGRESS ..... "
160 !
170 ! * Set start event.
180 !
190 OUTPUT Counter;"ESTART,0"
200 !
210 ! * Set delta event.
220 !
230 OUTPUT Counter;"EDELTA 1"
240 !
250 ! * Set data points.
260 OUTPUT Counter;"DATAPTS 10"
270 !
280 ! * Set command to get time vs freq table.
290 OUTPUT Counter;"PROF"
300 OUTPUT Counter;"TRIGGER"
310 !
320 I=0
330 PRINT ""
340 REPEAT
350     ENTER Counter;Timez$(I)
360     I=I+1
370 UNTIL Timez$(I-1)[1,3]="EOT"
380 Data_pts=I-2                      ! * Number of data points
390                                  ! * excluding "EOT".
400 I=0
410 REPEAT
420     PRINT Timez$(I)[1,8]          ! * Print time value, the value
430                                  ! * ends at 8th position. Max.
440                                  ! * of 10ms (i.e. total of 7
450                                  ! * digits allowed, 9999999
460                                  ! * is the maximum value.)
470     PRINT Timez$(I)[31,46]       ! * Print freq value, the value
480                                  ! * always ends at 46th position.
490                                  ! * The starting position is a
500                                  ! * function of the resolution
510                                  ! * and the freq value. For
520                                  ! * example, for 1Hz resolution,
530                                  ! * and 1.2 GHz freq value, the
540                                  ! * value starts at 31st position
550                                  ! * including the sign.
560     I=I+1
570 UNTIL I=Data_pts+1
580 END

```

# SPECIFICATIONS

---

## APPENDIX GUIDE

The Specifications<sup>1</sup> for the 5361B are described on the following pages. These specifications are the performance standards or limits against which the instrument can be tested. Performance test procedures for testable specifications are described in Appendix C. Some performance parameters are called "typical" or noted as "characteristic(s)". These values have no corresponding performance tests contained in Appendix C. This appendix is organized into the following three information groups. (NOTE: Specifications<sup>1</sup> footnotes are on page A-4.)

- Pulse and CW Specifications pgs. A-2 through A-4
- General and Enhanced Characteristics pg. A-5
- Option Specifications pg. A-6

Table A-1. HP 5361B Specifications

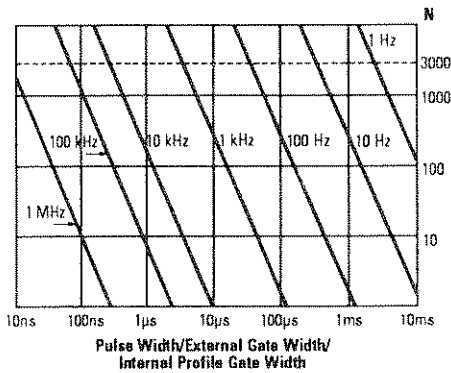

**Graph 1** - Resolution; number of pulses (N) vs. pulse width/external gate width/internal profile gate width. Gating Time = N x (PRI + 0.4 ms).\*\*

Pulse Width	K <sub>1</sub>	K <sub>2</sub> ms [hi-band, opt.040]
MANUAL ACQ. (< 100 ns)	10	180
100 ns to 250 ns	1200	1700
250 ns to 500 ns	250	360 [1700]
500 ns to 1.00 μs	120	360 [1700]
1.0 μs to 5.0 μs	30	360
>5.0 μs	12	360
ASSESS,PULSE/CW	780 - 1300 ms	

**Table 1** - Pulse Acquisition Time = (J\* x K<sub>1</sub>) x PRI\*\* + K<sub>2</sub>(in ms) + Assess\*\*\*

\* J = 1 unless signal carrier freq. is moving, then J=10.  
 \*\* PRI minimum = 200 μs for equations.  
 \*\*\* Assess only needs to be added when a change from Pulse/CW is done.

**Example:** For a PRI of 1 ms, pulse width of 10 μs, and a resolution set to 10 kHz, for a standard HP 5361B using automatic acquisition,  
**Gating Time** = (3) x (1 ms + 0.4ms) = 4.2ms  
**Acquisition Time** = (1 x 12) x 1 ms + 360 ms = 372 ms;  
**Measurement Time** = 4.2 ms + 372 ms + 200 ms = 576 ms.

**INPUT SPECIFICATIONS**

	Input 1 (50 Ω)	Input 2 (1 MΩ    70 pf)	Input 2 (50 Ω)
<b>Freq Range</b>	500MHz - 20, 26.5, 40 GHz	10 Hz - 80 MHz	10 MHz - 525 MHz
<b>Sensitivity</b>		25 mVrms	25 mVrms
0.5 - 12.4 GHz	-28 dBm		
12.4 - 20 GHz	-23 dBm		
0.5 - 26.5 GHz (opt. 026,040)	-20 dBm		
26.5 - 40 GHz (opt. 040)	dBm = 0.37 x f(in GHz) - 29.8		
<b>Maximum Input</b>	+7 dBm	1 Vrms	+10 dBm
<b>Damage Level</b>	+25 dBm	dc - 5 kHz: 250 V(dc + peak ac) >5 kHz: 5.5 Vrms + 1.25 10 <sup>+6</sup> Vrms/(Freq)	
<b>Connector (Std.) (opt. 026, 040)</b>	Type N, female 2.92 mm, male, compatible with APC 3.5 and Type A	BNC, female (with replaceable fuse).	
<b>SWR (Typical):</b>			
0.5 - 10 GHz	<2:1	NA	NA
10 - 20 GHz	<3:1		
20 - 26.5 GHz (opt. 026, 040)	<3:1		
26.5 - 40 GHz (opt. 040)	<3.5:1		

**FREQUENCY (INPUT 1)**

**Automatic Acquisition:**  
 500 MHz - 20 GHz;  
 500 MHz - 26.5 GHz (opt. 026, 040);  
 12 GHz - 40 GHz (opt. 040, high-band);  
 for CW and pulses > 100 ns.

**Manual Acquisition:**  
 500 MHz - 1 GHz, entered value = Input signal ± 3 MHz  
 1 GHz - 30 GHz, entered value = Input signal ± 20 MHz;  
 30 GHz - 40 GHz, entered value = Input signal ± 10 MHz;  
 for pulses < 100 ns, entered value = Input signal ± 3 MHz .

**Least Significant Digit:**  
 1 MHz to 1 Hz for frequency, 0.001 Hz for PRF.

**Residual Stability:**  
 1 LSD rms typical for 1 Hz resolution at 25°C, when counter and source use common 10 MHz time base or counter uses external high stability time base.

**Pulse Frequency Measurements**

**Pulse Width (Minimum):**  
 60 ns (< 100 ns mode, manual Acq.)<sup>3</sup>;  
 100 ns (Auto Acq.).

**Pulse Rep Freq:**  
 Min (low PRF mode)- 1 Hz (0 to 30°C).  
 Min/Max (Default)- 50 Hz/2 MHz .

**On/Off Ratio (Typical):** ≥15 dB.

**Maximum Video (Typical):**  
 ≥ (Signal level + 20 dB).

**FM Chirp Tolerance<sup>2</sup>:**  
 Manual Acq.- 50 MHz p-p (when entered value = center frequency ±1MHz).  
 Auto Acq.- 10 MHz p-p.

**Rise/Fall time (Typical, to remain in Pulse Mode):** ≤ 20 μs.

**Measurement Time (Typical)<sup>5</sup>:** Gating time + Acq. time + 200 ms (graph 1, table 1).

**Resolution<sup>4</sup>:** 1 Hz - 1 MHz (graph 2).

**Accuracy<sup>4</sup>:** Time base uncertainty (graph 4) + Gate Error (graph 3).

Table A-1. HP 5361B Specifications (Continued)

**CW Frequency Measurements**

**AM Tolerance (Typical):** ≤ 40% to 5 kHz;  
≤ 16%, above 5 kHz.

**FM Deviation (Typical, See Graph 5)<sup>6</sup>:**  
Manual Acq. (when entered value = center frequency ± 1 MHz) - 60 MHz p-p;  
55 MHz p-p (opt. 040).

Automatic Acq. - 20 MHz p-p;  
12 MHz p-p (opt. 040).

**FM Rate (Maximum)<sup>6</sup>:** 10 MHz.

**Tracking Speed<sup>7</sup>:**

Fast Acquisition Track - 800 MHz/s.  
Normal FM Rate - 1 MHz/s.  
Low FM Rate - 80 kHz/s.

**Acquisition Time (Manual Acq.):** < 40 ms.

**Acquisition Time (Automatic Acq.)<sup>6</sup>:**  
Fast Acquisition Track - < 100 ms.  
Normal FM Rate - < 170 ms.  
Low FM Rate - < 1.3 seconds.

**Gate Times (1 Hz Resolution):**

500 MHz - 5.7 GHz	200 ms
5.7 GHz - 11.3 GHz	400 ms
11.3 GHz - 16.9 GHz	600 ms
16.9 GHz - 22.5 GHz	800 ms
> 22.5 GHz	1000 ms

**Measurement Time (Typical)<sup>5</sup>:** Gate Time + Acquisition Time + 100 ms.

**Resolution:** 1 Hz - 1 MHz, selectable.

**Accuracy:** ± 1 LSDrms ± time base uncertainty (graph 4).

**PROFILE (INPUT 1)**

**Frequency Range (Min/Max for Y axis, see FM chirp tolerance for span):**

500 MHz/20 GHz.  
500 MHz/26.5 GHz (opt. 026).  
500 MHz/40 GHz (opt. 040).

**FM Chirp Tolerance<sup>2</sup> (Max span for Y axis):**  
Manual Acq.: 50 MHz p-p (when entered value = ± 1 MHz of center frequency).  
Auto Acq.: 10 MHz p-p.

**Time Range (Min/Max span for X axis):**  
100 ns/10 ms.

**Time Resolution:** 1 ns.

**Internal Gate Width:**

Minimum: 11 to 23 ns.  
Typical minimum: 14 ns.  
Maximum: 10 ms.

**External Gate Width (Minimum):**

Manual Acq.: 20 ns.  
Auto Acq.: 60 ns.

**Gating/Arming:**

Pulse- Internal, external arming, external gating.  
CW- External gating.

**Number of Data Points:**

Auto Profile: up to 75.  
Manual Profile: 1 to 99.

**Profile Frequency Measurements**

**Frequency Resolution:**

Selectable, 1 Hz to 1 MHz, dependent on internal profile gate width (graph 2).

**Printers Supported:** ThinkJet (HP 2225A), QuietJet Plus (HP 2227B), PaintJet (HP 3630A, opt. 002).

**Profile Phase Measurements**

See Application Note 377-4 for details.  
Computer required.

**Pulse Parameters (INPUT 1):** Measurements approx. 6 dB below signal peak.

	Pulse Width	PRI	Offtime	PRF
Min/Max	60 ns/10 ms	500 ns/1 s	400 ns/1 s	1 Hz/2 MHz
LSD	(PW < 1 ms)- 1 ns; (PW ≥ 1 ms)- 100 ns			to 0.001 Hz
Accuracy* (100 ave.)	± (20 ns + timebase error x Measurement) ± LSD			± (20 ns) x (PRF) <sup>2</sup> ± LSD ± Timebase uncertainty

\* for rise/fall times ≤ 20 ns.

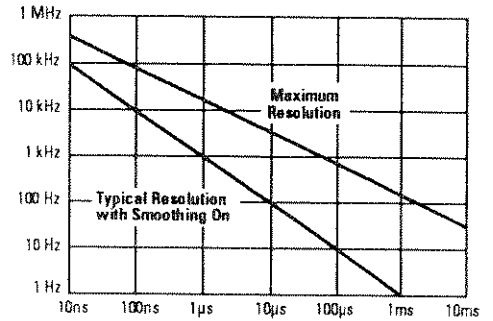

**Graph 2** - Maximum resolution as a function of pulse width/external gate width/internal profile gate width.

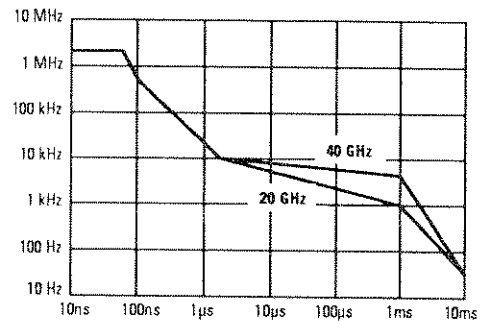

**Graph 3** - Maximum gate error as a function of pulse width/external gate width/internal profile gate width.

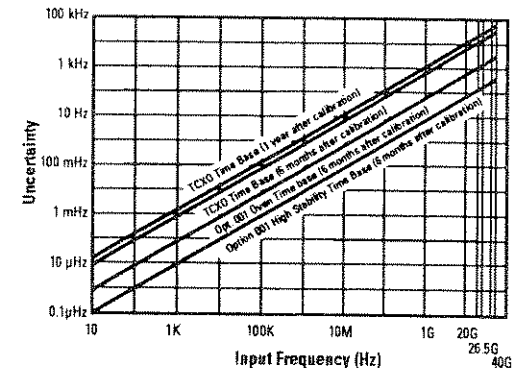

**Graph 4** - Time base uncertainty.

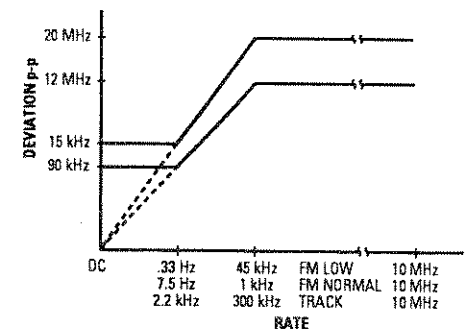

**Graph 5** - FM rate vs. deviation rate.

Table A-1. HP 5361B Specifications (Continued)

**FREQUENCY (INPUT 2)**

**Frequency Range:** 10 Hz to 525 MHz.

**Mode of Operation:**

50 Ω: 10 MHz to 525 MHz.

1 MΩ: 10 Hz to 80 MHz.

**Sensitivity:**

Full Operating Environment:

50 Ω: 10 MHz to 525 MHz, 25 mVrms.

1 MΩ: 10 MHz to 80 MHz, 25 mVrms.

@ 25°C (typical):

50 Ω: 10 MHz to 525 MHz, 15 mVrms.

1 MΩ: 10 Hz to 80 MHz, 15 mVrms.

**Gate Time:** 1/Resolution, 1ms minimum.

**Resolution:** selectable 1 Hz to 1 MHz.

**High Resolution:** 1 MΩ mode: 0.001 Hz for < 100 kHz input; 0.01 Hz for < 1 MHz input; 0.1 Hz for < 10 MHz; 1 Hz for > 10 MHz input; 1 second gate.

**Accuracy:** ± 1 LSD ±

$$\left( \frac{\text{Trigger Error}^8 \times \text{freq.}}{0.7 \times \text{Gate Time}} \right) \pm \text{Time Base Uncertainty}$$

(See Graph 3)

**Impedance (nominal):**

Selectable - 1 MΩ || 70 pf, or 50Ω.

**Coupling:** ac.

**Connector:** BNC with replaceable fuse.

**Maximum Input:** (50 Ω) - +10 dBm; (1 MΩ) - 1 Vrms.

**Damage Level:** 50 Ω or 10 MΩ.

dc to 5 kHz: 250 V (dc + ac peak);

>5 kHz: 5.5 Vrms (+ 28 dBm) + 1.25 X 10<sup>-6</sup>.

**TCXO TIME BASE**

**Crystal Frequency:** 10 MHz.

**Stability:**

Aging Rate- <1 x 10<sup>-7</sup> per month.

Short Term- <1 X 10<sup>-9</sup> for one second averaging time.

**Temperature:** <1 X 10<sup>-6</sup>, 0 - 50° C set to offset frequency at + 25° C.

**Line Variation:** <1 X 10<sup>-7</sup> for 10% change from nominal.

**Notes:**

1 Specifications herein describe the instrument's warranted performance. Typical or nominal measurement characteristics are intended to provide information useful in applying the instrument, but are non-warranted performance parameters.

2 For carriers from 1 GHz to 40 GHz and chirp mode on.

3 For carriers from 1 GHz to 40 GHz.

4 Resolution is the standard deviation of the measurement error, and accuracy is the mean. This can be approximated as Gaussian.

5 AGC setting time is 0.3 to 2.5 seconds (or 3 minutes for Low PRF mode). If signal amplitude is not steady state, this must be added to the measurement time.

6 Valid for Extended Function 92 (forced CW Mode). For carriers from 1 GHz to 40 GHz.

7 These tracking speeds ensure that an incorrect answer will not be displayed. The HP 5361B will display the correct answer or no answer. Valid for Extended Function 92 (Forced CW mode).

8 Trigger Error:  $\frac{\sqrt{e_i^2 + e_n^2}}{\text{Input Stew Rate in V/s at Trigger point}}$

Where  $e_i$  = Effective rms noise of counter's input channel (100 μV typical).  
 $e_n$  = rms noise of the input signal for a 500 MHz bandwidth.



Table A-1. HP 5361B Specifications (Continued)

## Characteristics\*

### GENERAL

**Display:** 24 character alpha-numeric LCD.

**Keyboard Setup:** Setup stored by STBY mode.

**Self-Check:** Performs internal checks and gate bias calibration.

**Calibrate:** Calibrates gate error at power up and when self check/cal is requested.

**Lockout:** Display and Keyboard, see manual.

**Data Output:** HP-IB to HP 350, with Ext. Function 92 and "Dump Mode"; varies with freq., resolution, and Mode. CW- (10 kHz resolution).

Automatic Mode: 100 readings/s.  
Manual Mode: 120 readings/s.

Pulse- (10 kHz res., 5 kHz PRF, and 10 ms PW).

Automatic Mode: 4 readings/s.  
Manual Mode: 10 readings/s.

**Sample Rate:** Variable from less than 50 msec to infinite (HOLD).

**Display Rate:** 5/s for 1 kHz resolution, CW.

**Low Emission Mode:** Input 1 emissions reduced to < -70 dBm typical when sleep mode or input 2 is selected.

**HP-IB:** Functions and Extended Functions are programmable. Address settable from front panel. Teach/Learn programming IEEE 728 compatible command structure.

**Operating Temperature:** 0° C to 50° C.

**Power Requirements:** 100 VA Max.

Line select-

100 V (90 - 105 VAC; 47.5 - 440 Hz);  
115/120 V (104-126 VAC; 47.5 - 440Hz);  
220 V (198 - 231 VAC; 47.5 - 66 Hz);  
230/240 V (207-252 VAC; 47.5 - 66 Hz).

**Extended Functions:** Set sampler LO frequency; set gate width in time; force pulse or CW mode; <100 ns pulse width mode; high resolution mode; set gate width in IF periods; and 11 settable profile parameters.

**Size:** 133mm H x 407 mm W x 358mm D;  
5.25 in. H x 16 in. W x 14 in. D.

**Weight:** 11 kg (24 lbs).

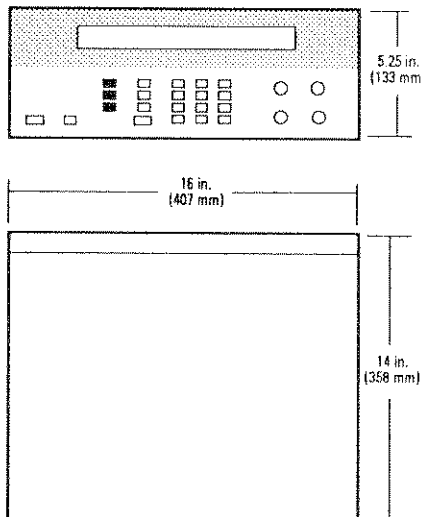

**Level Indicator:** "LEVEL", indicates AGC is leveling, check that input range is not exceeded.

**IF Output:** Rear panel BNC provides 30 to 110 MHz down-converted microwave signal at ~ -13 dBm into 50 Ω, ac coupled.

**Scope-view:** Digital version of the IF + internal gate. The pulse is represented as the IF of the down-converted pulse (nominally 300 mv p-p) with an average value of -0.8 volts. The gated portion of the signal is offset to an average value of -1.2 volts, illustrating the measurement interval.

**Pulse Output:** 1 to 0 volts into 50 Ω. Delay from detected pulse 15 nsec, nominal.

**Ext. Gate/Arm Input:** Input requires a TTL active low edge (armed) or level (gate). Input impedance is 1.5 k Ω || 30 pf, connected to 3.3 Volts. Delay from external gate/arm edge to measurement 15 nsec.

**Time Base Output:** 10 MHz and 1 MHz, >2.4 V square wave ac coupled into 1 k Ω or >1.5 Vp-p into 50 Ω. Available at rear panel BNC connectors whenever the instrument has ac power connected.

**External Time Base:** 1, 2, 5, 10 MHz, 0.7 volts minimum to 8 V maximum p-p sine wave or square wave into >1 k Ω shunted by <30 pf. The external reference is automatically selected when a signal is present and an indicator (▼) appears in the display. TCXO power is turned off, oven heater on, oscillator signal disconnected.

### Gate Modes (Input 1):

**Internal Gate-** Automatically gate on either CW or pulsed signals.

**External Gate-** A low TTL signal on the Gate/Arm Input determines when a frequency measurement is made.

**External Arm-** A high to low TTL edge enables a measurement on the next pulse. The edge must occur 50 ns (typical) prior to the pulse to be measured. The edge must also occur during the pulse offtime.

**Math Functions:** Result = (Measurement x scale) + offset.

**Offset-** Measurement is offset by entered value.

**Scale-** Measurement is multiplied by entered value.

**Smooth (Input 1)-** Displayed resolution is determined using exponential averaging; displays only stable digits, and increases resolution.

\* Characteristics are intended to provide information useful in applying the instrument by giving TYPICAL but nonwarranted performance parameters.

Table A-1. HP 5361B Specifications (Continued)

**OPTIONAL OVEN TIME BASE,  
OPTION 001**

**Crystal Frequency:** 10 MHz.

**Stability:**

**Aging Rate-**  $<5 \times 10^{-10}$  per day after 24 hr warm up when off-time is  $<24$  hrs and aging rate is  $<5 \times 10^{-10}$  per day prior to turn off.  $<5 \times 10^{-10}$  per day in  $<30$  days of continuous operation for off-time  $>24$  hrs.  $<1 \times 10^{-7}$  per year for continuous operation.

**Short Term-**  $<1 \times 10^{-10}$  for 1 second averaging time.

**Temperature:**  $<7 \times 10^{-9}$ , 0 - 50° C.

**Line Variation:**  $<1 \times 10^{-10}$  for 10% change from nominal.

**Warm Up:**  $<5 \times 10^{-9}$  of final value 10 minutes after turn-on at 25° C when off-time is  $<24$  hours and the aging rate is  $<5 \times 10^{-10}$  per day prior to turn off.\*

**OPTIONAL INCREASED  
DAMAGE LEVEL, OPTION 006**

Protects input 1 from damage by limiting high level signals. All specifications are the same except Input 1.

**Damage Level (Pulsed):**

+50 dBm (100 Watts) peak, pulse width  $\leq 1 \mu\text{s}$  0.001 duty cycle, typical.

**Damage Level (CW):**

500 MHz to 6 GHz- +39 dBm (8Watts);  
6 GHz to 18 GHz- +36 dBm (4 Watts);  
18 GHz to 26.5 GHz- +34.8 dBm (3 Watts).

**Sensitivity (Insertion Loss):** 3 dB,  
500 MHz to 12.4 GHz; 4 dB, 12.4 GHz  
to 20 GHz; 5 dB, 20 GHz to 26.5 GHz .

**SWR:** (500 MHz to 10 GHz)  $<2.5:1$  typical;  
(10 GHz to 26.5 GHz)  $<3.5:1$  typical.

**OPTIONAL OVEN TIME BASE,  
OPTION 010**

**Crystal Frequency:** 10 MHz.

**Stability:**

**Aging Rate-**  $<7 \times 10^{-10}$  per week after 24 hr warm up when off-time is  $<24$  hrs and aging rate is  $<7 \times 10^{-10}$  per week prior to turn off.  $<7 \times 10^{-10}$  per week in  $<30$  days of continuous operation when off-time  $>24$  hrs.  $<2 \times 10^{-8}$  per year for continuous operation.

**Short Term-**  $<1 \times 10^{-10}$  for 1 second averaging time.

**Temperature:**  $<7 \times 10^{-9}$ , 0 - 50° C.

**Line Variation:**  $<1 \times 10^{-10}$  for 10% change from nominal.

**Warm Up:**  $<5 \times 10^{-9}$  of final value 10 minutes after turn-on at 25° C when off-time is  $<24$  hours and the aging rate is  $<7 \times 10^{-10}$  per week prior to turn off.\*

**OPTIONAL FREQUENCY  
EXTENSION, OPTION 026**

**Frequency Range (input 1):**  
500 MHz - 26.5 GHz .

**OPTIONAL FREQUENCY  
EXTENSION, OPTION 040**

**Frequency Range (Input 1):**  
500 MHz - 40 GHz .

Note: Options 006 and 700 are incompatible with Option 040.

**OPTIONAL MATE  
PROGRAMMING CAPABILITY,  
OPTION 700**

**Built-in CIL operating codes:**

CIL Operating Codes: FNC, SET, SRX,  
SRN, INX, FTH, CLS, OPN, RST, CNF,  
IST, STA, GAL.

**MATE Interface Standard:**

2806763 Rev. B.

Note: Option 040 and the profile function are incompatible with option 700.

\* Final value is the frequency after 24 hours of continuous operation. An indicator (▼) appears in the display until the oven is at operating temperature.

# INSTALLATION

---

## APPENDIX GUIDE

This appendix provides you with information for unpacking, inspecting, installing, and storing the HP 5361B Microwave Frequency Pulse Counter. In addition, this appendix describes operator maintenance procedures which must be performed to ensure proper operation of the HP 5361B.

### Where to Find Important Topics

- Ac Fuses pg. B-2
- Ac Power pg. B-2
- HP-IB Configuration pg. B-6
- Installing Options pg. B-10
- Instrument Handling and Shipment pg. B-8

### Appendix Summary

- Initial Inspection pg. B-1
- Preparation for Use pg. B-2
- Hewlett-Packard Interface Bus pg. B-6
- Storage and Shipment pg. B-8
- Operator's Maintenance pg. B-9
- Field Installation of Options pg. B-10

## INITIAL INSPECTION

If the shipping carton is damaged, inspect the instrument for visible damage (scratches, dents, etc.). If the instrument is damaged, notify the carrier and the nearest Hewlett-Packard Sales and Support office immediately (offices are listed at the back of this manual). Keep the shipping carton and packing material for the carrier's inspection. The Hewlett-Packard office will arrange for repair or replacement of your instrument without waiting for the claim against the carrier to be settled.

## PREPARATION FOR USE

The following paragraphs describe the power requirements, line voltage selection procedure, power cables available, and operating environment for the HP 5361B.

### Power Requirements

The HP 5361B requires a power source of 100 Vac or 115/120 Vac (+5%, -10%) at 47.5 Hz to 440 Hz single phase, or 220 Vac or 230/240 Vac (+5%, -10%) at 47.5 Hz to 66 Hz single phase; 100 VA maximum.

### CAUTION

---

*Before connecting the instrument to ac power lines, you must install the correct fuse and properly position the line voltage selector as described below.*

---

### Line Voltage and Fuse Selection

The HP 5361B is equipped with an ac power module that contains a printed-circuit line voltage selector card. The selector card can be positioned to select 100, 120, 220, or 240 Vac operation. When the card is installed in the module, the selected voltage is indicated by the only visible marking on the card.

You must install the correct value of line fuse (with a 250 V rating) after inserting the circuit card. The HP 5361B uses a 1.00 A time delay fuse (HP Part No. 2110-0007) for 100/120 V operation, or a 0.5 A time delay fuse (HP Part No. 2110-0202) for 220/240 V operation.

To convert from one line voltage to another or to change the fuse:

1. Disconnect the power cord from the power module.
2. Move the sliding window covering the card compartment to expose the circuit card and fuse (see *Figure B-1*).

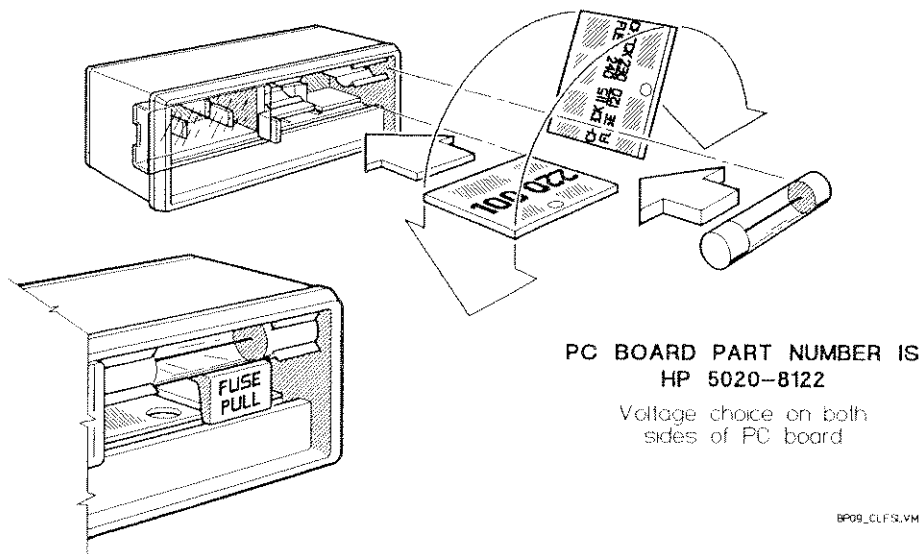

Figure B-1. Changing the Line Fuse and Selecting the Line Voltage

3. Pull on the fuse lever to remove the fuse.
4. Pull the card out of the module. You must hold the fuse lever to one side to extract and insert the card.
5. Insert the card so the marking indicating the desired line voltage is visible.
6. Return the fuse lever to normal position.
7. Insert the correct fuse,
8. Slide the plastic window over the compartment and connect the connect the power cable.

The instrument is now ready for operation.

## Power Cable

The HP 5361B is shipped with a three-wire power cable (W1). When the power cable is connected to an appropriate ac power source, it connects the chassis to earth ground. The type of plug at the end of the power cable shipped with the instrument depends on the country of destination. Refer to *Table B-1* for the HP part numbers of the power cable and plug configurations available.







### **WARNING**

---

**BEFORE SWITCHING ON THE INSTRUMENT, BE SURE THAT THE POWER CABLE IS INSERTED ONLY IN A SOCKET OUTLET PROVIDED WITH A PROTECTIVE EARTH CONTACT, AND THAT THE PROTECTIVE EARTH TERMINAL OF THE INSTRUMENT IS CONNECTED TO THE PROTECTIVE CONDUCTOR OF THE POWER CABLE. DO NOT USE A POWER EXTENSION CABLE WITHOUT A PROTECTIVE GROUNDING (EARTHING) CONDUCTOR, AS DOING SO WILL NEGATE THE PROTECTIVE ACTION OF THE POWER CABLE GROUND CONDUCTOR.**

---

Table B-1. AC Power Cables Available

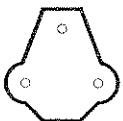
Plug Type	Cable HP Part No.	*C D	Plug Description	Cable Length (Inches)	Cable Color	For Use In Country
250V 	8120-1351 8120-1703	0 6	Straight **BS1363A 90°	90 90	Mint Gray Mint Gray	United Kingdom, Cyprus, Nigeria, Rhodesia, Singapore
250V 	8120-1369 8120-0696	0 4	Straight **NZSS198/ASC112 90°	79 87	Gray Gray	Australia, New Zealand
250V 	8120-1689 8120-1692	7 2	Straight **CEE7-Y11 90°	79 79	Mint Gray Mint Gray	East and West Europe, Egypt, (Unpolarized in many nations)
125V 	8120-1348 8120-1398 8120-1754 8120-1378 8120-1521 8120-1676 8120-4753	5 5 7 1 6 2	Straight **NEMA5-15P 90° Straight **NEMA5-15P Straight **NEMA5-15P 90° Straight **NEMA5-15P Straight **NEMA5-15P	80 80 36 80 80 30 90	Black Black Black Jade Gray Jade Gray Jade Gray Dark Gray	United States, Canada, 100V or 200V, Mexico, Philippines, Taiwan, Saudi Arabia, Japan
250V 	8120-2104	3	Straight **SEV1011 1959-24507 Type 12	79	Gray	Switzerland
250V 	8120-0698	6	Straight **NEMA6-15P			United States, Canada
220V 	8120-2956 8120-2957	2 3	Straight **DHCK 107 90°	79 79	Gray Gray	Denmark
220V 	8120-4211 8120-4600		Straight 90°		Gray Gray	South Africa, India

\*CD = Check Digit (refer to Replaceable Parts in Service Manual).

\*\*Part number shown for plug is industry identifier for plug only. Number shown for cable is HP Part Number for complete cable including plug.

E = Earth Ground L = Line N = Neutral

## Operating Environment

The HP 5361B operates within a temperature range of 0° to +50° C.

## HEWLETT-PACKARD INTERFACE BUS

The HP 5361B can be remotely controlled over the Hewlett-Packard Interface Bus (HP-IB). The rear panel HP-IB connector is compatible with HP 10833A/B/C/D cables (Refer to *Figure B-2* for interconnection data concerning the rear panel connector and to *Table B-2* for cable descriptions). The following paragraphs briefly describe the features of the HP-IB system.

### HP-IB Interconnections

The HP-IB system allows you to interconnect up to 15 HP-IB compatible instruments (including the controller). The HP-IB cables have identical piggy-back connectors on both ends so that several cables can be connected to a single source without requiring special adapters or switch boxes. System components and devices can be connected in virtually any configuration desired. There must, of course, be a connection from the controller to every device operating on the bus.

### CAUTION

---

***Avoid stacking more than three or four cables on any one connector. If the stack gets too large, the force on the stack produces leverage that can damage the connector mounting.***

***Be sure each connector is firmly (finger tight) screwed in place to keep it from working loose during use. DO NOT use a screwdriver to tighten the connector lockscrew, as doing so may damage the threads inside the head of the lock-screw.***

---

*Table B-2. HP-IB Cable Descriptions*

Model Number	Cable Length
10833A	1 metre (3.3 ft.)
10833B	2 metres (6.6 ft.)
10833C	4 metres (13.2 ft.)
10833D	0.5 metres (1.6 ft.)



**PIN LINE**

- 1 DIO1
- 2 DIO2
- 3 DIO3
- 4 DIO4
- 13 DIO5
- 14 DIO6
- 15 DIO7
- 16 DIO8
- 5 EOI
- 17 REN
- 6 DAV
- 7 NRFD
- 8 NDAC
- 9 IFC
- 10 SRQ
- 11 ATN
- 12 SHIELD-CHASSIS GROUND
- 18 P/O TWISTED PAIR WITH PIN 6
- 19 P/O TWISTED PAIR WITH PIN 7
- 20 P/O TWISTED PAIR WITH PIN 8
- 21 P/O TWISTED PAIR WITH PIN 9
- 22 P/O TWISTED PAIR WITH PIN 10
- 23 P/O TWISTED PAIR WITH PIN 11
- 24 ISOLATED DIGITAL GROUND

THESE PINS  
ARE  
INTERNALLY  
GROUNDED

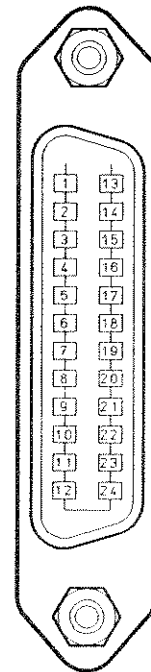

**CAUTION**

The 5361B contains metric threaded HP-IB cable mounting studs as opposed to English threads. Metric threaded HP 10833A, B, C, or D HP-IB cable lock screws must be used to secure the cable to the instrument. Identification of the two types of mounting studs and lock screws is made by their color. English threaded fasteners are colored silver and metric threaded fasteners are colored black. DO NOT mate silver and black fasteners to each other or the threads of either or both will be destroyed.

HP-IB MOUNTING  
STUD  
0380-1332



**Logic Levels**

The Hewlett-Packard Interface Bus logic levels are TTL compatible, i.e., the true (1) state is 0.0V dc to +0.8V dc and the false (0) state is +2.0V dc to +5.0V dc.

**Programming and Output Data Format**

Refer to Section IV, Remote Operation Via HP-IB

**Mating Connector**

HP 1251-7162; Amphenol 57-92245.

**Mating Cables Available**

HP 10833A, 1 metre (3.3 ft.), HP 10833B, 2 metres (6.6 ft.)  
HP 10833C, 4 metres (13.2 ft.), HP 10833D, 1/2 metre (1.6 ft.)

**Cabling Restrictions**

1. A Hewlett-Packard Interface Bus System may contain no more than 2 metres (6.6 ft.) of connecting cable per instrument.
2. The maximum accumulative length of connecting cable for any Hewlett-Packard Interface Bus System is 20.0 metres (65.6 ft.).
3. The maximum number of instruments in one system is fifteen.

Figure B-2. Hewlett-Packard Interface Bus Connection

## Cable Length Restrictions

To obtain maximum performance with the HP-IB, you must obey certain cable length restrictions. These restrictions are necessary to maintain the proper voltage levels and timing relationships. If the system cable is too long, the system will fail to perform properly. Therefore, when interconnecting an HP-IB system, observe the following rules:

- a. The total cable length for the system must be less than or equal to 20 metres (65 feet).
- b. The total cable length for the system must be less than or equal to 2 metres (6.6 feet) times the total number of devices connected to the bus.
- c. The total number of devices connected to the bus must not exceed 15.

## HP-IB Talk/Listen Address

There are two ways to set the HP-IB instrument address for remote operation: setting the rear panel address switch, and front panel keyboard entry. The address setting determines the mode of remote operation as Talk Only (address 31) or Addressable (addresses 1 through 30).

An address entered as numeric data via the front panel keyboard overrides the address setting of the rear panel switch, and is retained by the counter as long as ac power is connected. Instructions for setting the address using either method are given in Section 4. To avoid unintentional HP-IB address change, do not interrupt power up sequence, that is, toggling STBY/ON power switch of the HP 5361B.

## HP-IB Description

Additional information about the design criteria and operation of the Hewlett-Packard Interface Bus is available in Section 4 and IEEE Standard 488-1978, "IEEE Standard Digital Interface for Programmable Instrumentation".

## STORAGE AND SHIPMENT

The following paragraphs describe the conditions under which the HP 5361B can be stored or shipped, and the types of packaging in which the instrument can be shipped.

### Environment

The HP 5361B can be stored or shipped within a temperature range of  $-40^{\circ}$  C to  $+75^{\circ}$  C.

The instrument should be protected from temperature and humidity extremes which cause condensation within the instrument.

## Packaging

The following procedure describes how to repack the instrument using commercially available material; however, containers and materials identical to those used in the factory packaging are available through Hewlett-Packard offices.

1. Wrap the instrument in materials that do not generate static or are anti-static.
2. If shipping the instrument to a Hewlett-Packard office or service center, attach a tag indicating the type of service required, return address, model number, and full serial number.
3. Use a strong shipping container. A double-walled carton made of 350-pound test material is adequate.
4. Use a layer of shock-absorbing material 70 to 100 mm (3 to 4 inches) thick around the sides of the instrument to provide firm cushioning and prevent movement inside the container. Protect the front panel with cardboard.
5. Seal the shipping container securely.
6. Mark the shipping container FRAGILE to ensure careful handling.
7. If you need to call or write to Hewlett-Packard concerning the instrument shipment be sure to include both the product model number and full serial number.

## OPERATOR'S MAINTENANCE

The only maintenance normally required is replacement, when necessary, of two fuses: the primary power fuse (F1) located within the ac power module on the rear panel, and the low frequency input fuse (J2F1) located in the front panel INPUT 2 connector. Instructions for changing the primary power fuse are given on page B-2, Line Voltage and Fuse Selection.

### CAUTION

---

***Be sure that only time delay (slow-blow) type fuses with the required voltage and current ratings are used for replacement of the primary power fuse. Do not use repaired fuses or short-circuited fuseholders.***

---

The low frequency input fuse (J2F1) is a 1/8 A fuse (HP Part No. 2110-0301) located within the INPUT 2 BNC connector J2 (HP Part No. 1250-1899), as shown in *Figure B-3*.

PART NUMBER FOR THE  
J2 CONNECTOR INCLUDING  
FUSE J2F1 IS 1250-1899

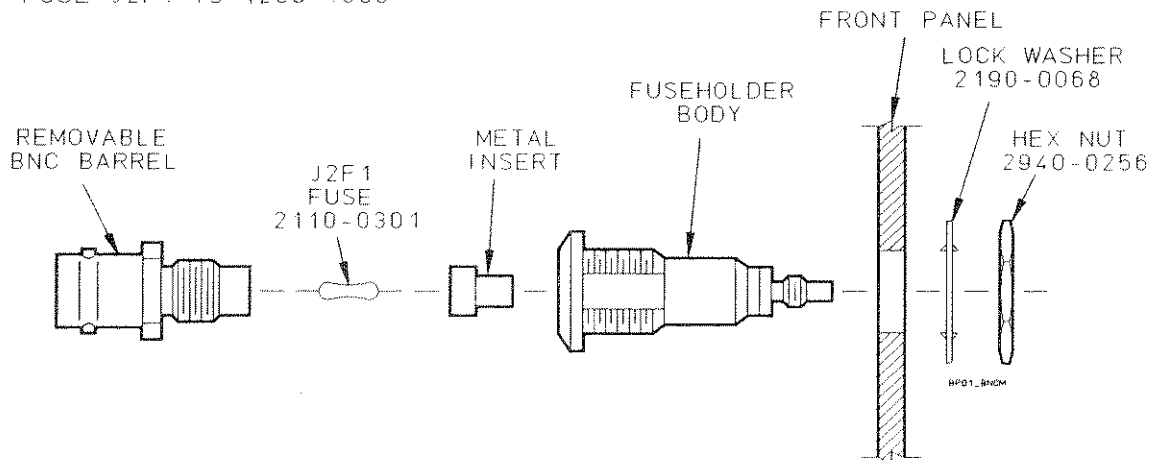

NOTE USE A 7/16 INCH WRENCH TO REMOVE AND TIGHTEN THE BNC BARREL.

Figure B-3. Details of INPUT 2 Connector and Low Frequency Input Fuse

To replace the low frequency input fuse:

1. Disconnect the power cord.
2. Unscrew the BNC barrel.
3. Remove the fuse using needle-nose pliers.
4. Install the replacement fuse using the needle-nose pliers.
5. Reinstall the BNC barrel, being careful that the fuse wire is aligned to fit into the center conductor of the barrel; if not properly aligned, the fuse will be crushed inside the fuseholder body.
6. Tighten the BNC barrel with a 7/16 inch wrench to 20 inch-pounds.

## FIELD INSTALLATION OF OPTIONS

The following paragraphs describe the installation procedures for all field-installable options for the HP 5361B. To obtain the necessary parts for installation of an option, order the parts for the desired option listed in *Table B-3*. Refer to the HP 5361B Service Manual for ordering information.

After field installation of an option, you should update the rear panel OPTIONS label to identify the option that has been installed. To update the label, fill in the small circle next to the appropriate option name with a marking pen.

**WARNING**

TO PREVENT ELECTRIC SHOCK, BE SURE TO DISCONNECT AC POWER TO THE INSTRUMENT BEFORE INSTALLING ANY OPTIONS. CAPACITORS INSIDE THE INSTRUMENT MAY STILL CONTAIN A CHARGE AFTER AC POWER HAS BEEN REMOVED. ALL OPTIONS SHOULD BE INSTALLED ONLY BY QUALIFIED SERVICE PERSONNEL WHO ARE AWARE OF THE HAZARDS INVOLVED.

**CAUTION**

*Integrated circuit assemblies in the instrument can be damaged by electrostatic discharge (ESD). Use the following precautions:*

*ENSURE that all option installations are performed at a static-safe work station.*

*DO NOT wear clothing subject to static charge, such as wool or synthetic material.*

Table B-3. Field Installable Options

Option	Part Description	Ref. Desig.	Part Number
001	Oven Oscillator Timebase	A10	10811-60111
	2 Mounting Screws	A10H1	2360-0115
006	Limiter Option Cable	W10	05350-60111
	Limiter	AT1	5088-7049
010	High Stability Timebase	A10	10811-60211
	2 Mounting Screws	A10H1	2360-0115

### Installation of Option 001 or Option 010 Time Base

The Option 001 Oven Oscillator Time Base and Option 010 High Stability Oscillator Time Base are installed exactly the same way. Each option consists of an oven controlled crystal oscillator time base (HP Part No. 10811-60111 for Option 001, 10811-60211 for Option 010). Either option is installed in the XA10 connector on the motherboard, replacing the standard A10 oscillator. To install Option 001 or 010, proceed as follows:

1. Disconnect ac power from the instrument.
2. Remove top and bottom covers from the instrument.
3. Remove the standard timebase oscillator (A8Y1).
4. Install the Option 001 or 010 (A10) oscillator into the XA10 connector.

5. Secure the oscillator to the motherboard from underneath with the two mounting screws provided with the option kit (A10H1).
6. Replace bottom cover of the instrument.
7. Perform the Option 001/010 oscillator adjustment described in Section 1, Adjustments of the HP 5361B Service Manual.
8. Replace top cover of the instrument.

### **Installation of Option 006 Limiter**

Option 006 consists of a microwave limiter (HP Part No. 5088-7049) inserted in series between the INPUT 1 connector on the front panel and the input to the Microwave Module (U1J1). The following procedure describes only those steps pertaining to Option 006 installation; refer to Section 3 of the HP 5361B Service Manual for overall instrument disassembly procedures.

To install Option 006, proceed as follows:

1. Disconnect ac power from the instrument.
2. Remove the top cover.
3. Remove the front panel assembly, with the attached Microwave Module, from the front frame of the instrument. (Refer to the disassembly procedures in Section 3 of the Service manual).
4. Unscrew the knurled nut (H12) from the INPUT 1 type-N connector on the High Frequency Input Cable (W6), and separate the Microwave Module from the front panel assembly.
5. Disconnect the W6 input cable from the Microwave Module, using a 5/16 inch wrench. Set the W6 cable aside, as it is not used for Option 006 installation.
6. Insert the type-N connector on the Option 006 Input Cable (W10) into the rectangular hole in the mounting bracket of the Microwave Module.
7. Connect the Microwave Limiter (AT1) to the SMA connector of the W10 cable. DO NOT TIGHTEN the connection all the way. Connect the other end of the Limiter to the U1J1 connector of the Microwave Module.

**NOTE**

---

*The limiter may be installed pointing in either direction.*

---

8. Carefully tighten the SMA connections at both ends of the Limiter, using a 5/16-inch wrench. DO NOT OVERTIGHTEN the SMA connections.
9. Insert the Microwave Module back into the front panel assembly, and reinstall the front panel assembly into the instrument frame. (Refer to reassembly procedures in Section 3 of the Service Manual).
10. Screw the H12 knurled nut onto the INPUT 1 connector, and carefully tighten it with a 3/4-inch knurled nut driver.
11. Replace the top cover.
12. Perform the tests described in Appendix C, Performance Tests to verify that the instrument meets the Option 006 specifications in *Table A-1*.





# PERFORMANCE TESTS

---

## APPENDIX GUIDE

This section provides you with procedures for testing the electrical performance of the HP 5361B Microwave Frequency Pulse Counter, by using the specifications listed in Appendix A as performance standards. Three kinds of testing are described: operation verification, HP-IB verification, and complete performance testing.

### Where to Find Important Topics

- |                                 |               |
|---------------------------------|---------------|
| ■ FM Tolerance                  | pg. C-25      |
| ■ GATE/ARM IN Test              | pg. C-30      |
| ■ INPUT 1: Pulse Sensitivity    | pg. C-9/C-21  |
| ■ INPUT 1: CW Sensitivity       | pg. C-7/C-20  |
| ■ INPUT 2: CW Sensitivity       | pg. C-5/C-19  |
| ■ Operation Verification Record | pg. C-15      |
| ■ Performance Test Record       | pg. C-17      |
| ■ Power-up Self Check           | pg. C-4       |
| ■ Pulse Envelope Tests          | pg. C-27/C-30 |
| ■ Pulse Frequency Profile Test  | pg. C-24      |
| ■ Recommended Test Equipment    | pg. C-3       |

### Appendix Summary

- |                                |              |
|--------------------------------|--------------|
| ■ Operation Verification       | pg. C-2/C-4  |
| ■ HP-IB Verification           | pg. C-2/C-12 |
| ■ Complete Performance Testing | pg. C-2/C-19 |
| ■ Equipment Required           | pg. C-2/C-3  |
| ■ Calibration Cycle            | pg. C-4      |
| ■ HP-IB Verification Program   | pg. C-36     |

## OPERATION VERIFICATION

If you suspect the HP 5361B is not working correctly, you may perform the operation verification procedure. This procedure is an abbreviated set of tests that give a high degree of confidence the instrument is operating properly without performing the complete Performance Test. An Operation Verification would be useful for incoming inspection, routine maintenance, and after instrument repair.

## HP-IB VERIFICATION

The HP-IB verification program, allows you to exercise the instrument through most of its command set via the HP-IB interface. The program is written for a Series 300 HP 9000 as the controller. If the instrument successfully completes all phases of the verification program, there is a very high probability the HP-IB interface and the counter are working properly. The HP-IB program is available on a disk, HP Part No. 05361-13501 (3 1/2" media) and 05361-13052 (5 1/4" media).

## COMPLETE PERFORMANCE TESTING

The complete Performance Test procedures begin immediately following the HP-IB verification subsection. All tests can be performed without access to the inside of the instrument.

## EQUIPMENT REQUIRED

The equipment required for all test procedures in this section is listed in *Table C-1* below. Any equipment that satisfies the required characteristics given in the table may be substituted for the recommended models.

Table C-1. Recommended Test Equipment

INSTRUMENT	REQUIRED CHARACTERISTICS	USE*	RECOMMENDED MODEL
Oscilloscope	275 MHz bandwidth, delayed sweep	T,A,P	HP 54201A or equivalent
Oscilloscope probe	High impedance (10:1), minimal capacitance (8-10pf)	T,A	HP 10433A or equivalent
Active probe	≥350 MHz 100:1 divide capability	T	HP 1124A or equivalent
High Impedance Oscilloscope probe	10MΩ or greater	T	HP 10432A or equivalent
Storage Oscilloscope	100 MHz bandwidth storage capability	T	HP 54201A or equivalent
Sweep Oscillator	.01-20 GHz FM modulation - 20 MHz	P	HP 8620C mainframe/ HP 86222A/B plug-in or equivalent
Synthesized Signal Generator	10 MHz to 2.5 GHz	T,A	HP 8660D mainframe/ HP 86603A plug-in
Synthesized Sweeper	10 MHz to 26.5 GHz	A,P	HP 8340B or equivalent
Synthesizer	10 Hz to 10 MHz	OV,P	HP 3325B or equivalent
Spectrum Analyzer	RF inputs from 1 MHz to 500 MHz	T,P,A	HP 8566B or equivalent
Digital Voltmeter	4½ digit	T,A	HP 3466A
Power Sensor	50 MHz to 20 GHz	A,OV,P	HP 8485A
Power Meter	50 MHz to 20 GHz	A,OV,P	HP 436A
Power Splitter	DC to 26.5 GHz	OV,P	HP 11667B
50 Ω Feedthrough	BNC male to BNC female	OV,P	HP 10100C
Fixed Attenuator	10 dB ±1dB	P	HP 8493C
Fixed Attenuator	20 dB Attenuation	A	HP 8491A Option 20
Pulse Generator	1 to 20 μs pulse width 1 to 20 μs PRI	OV,P	HP 8012B or equivalent
Time Synthesizer	1 to 20 μs pulse width 1 to 20 μs PRI	OV,P	HP 5359A or equivalent
Instrument Controller	BASIC 5.0 Control Language, HP-IB Interface Capability	OV	HP 9000 Series 300 (or equivalent)
* T = Troubleshooting A = Adjustments	OV = Operation Verification P = Full Performance Testing		

## CALIBRATION CYCLE

The HP 5361B requires periodic verification of correct operation. You should use the operation verification procedure at least once every year, depending on environment and use. A full calibration procedure, including adjustments and a full performance test, should be performed at least once every 6 months for instruments equipped with the standard TCXO timebase, at least once a year for instruments equipped with the Option 001 Oven Oscillator Timebase, and once every 5 years for instruments equipped with the Option 010 High Stability Timebase. When you use these calibration cycles, kHz accuracy of the HP 5361B is ensured.

## Test Specifications with Option 006

All test and verification procedures described in this section are intended for testing of the standard HP 5361B. If Option 006 (Limiter) is installed the sensitivity specifications of the counter will be different from the standard instrument. If your HP 5361B is so equipped, use the same procedures as for the standard instrument, but observe the option specifications listed in Appendix A, *Table A-1* as performance standards.

### NOTE

---

*The following operation verification and performance test procedures require measurement of the actual input sensitivity of the 5361B. The actual sensitivity MUST be measured as follows:*

- 1. Before measuring, be sure to calibrate the power meter according to the frequency calibration data provided on the power sensor to be used in the test.*
  - 2. To measure actual sensitivity, decrease the input level to the counter until it stops counting, then slowly increase the input level until the counter measures the input properly (as defined by the particular procedure being performed).*
- 

## OPERATION VERIFICATION PROCEDURE

### Power-Up Self Check

1. Before connecting the power cord and switching on the instrument, be sure that the line voltage selector is properly set, the correct fuse is installed, and all safety precautions have been observed.
2. Set the POWER switch to the ON position and verify the Power-up Self Check routine, as follows:
  - a. Immediately after switching the power on, the counter performs a starburst display test in which all segments of the liquid crystal display are turned on.

The display should remain in this state for about three seconds. Check that no segments are missing.

- b. If any of the internal tests fail, the results of the first test failing will be displayed after the display test and EFUN 54 display. Pressing the RESET/LOCAL key will display the next test, if any, failing. When all failing tests have been displayed, the HP-IB address will be displayed for about two seconds. If all tests pass, the HP-IB address will be displayed immediately after the display test.
  - c. After the HP-IB address is displayed, the counter should go into the measurement mode last selected (if the counter had previously been left in Standby), or into the Auto mode with defaults set as described in Section 2 (if AC power had previously been disconnected from the counter).
  - d. If a FAIL message is displayed during the Power-Up Self-Test, refer to troubleshooting procedures in Section 5, Service, for information about specific diagnostic failures.
3. Enter results of the Power-Up Self-Test on the Operation Verification Record (Table C-3).

## INPUT 2, CW Counting Check

1. Set the counter to the Input 2, 50  $\Omega$  impedance mode by pressing the 50  $\Omega$  key.
2. Connect the rear panel 10MHZ OUT BNC to the front panel INPUT 2. Verify that the instrument displays: 10 000 000 ( $\pm 1$  Hz).
3. Enter results on the Operation Verification Record.

## INPUT 2, 10 Hz - 525 MHz CW Input Sensitivity Test

The following test is in two parts, Setup 1 for 50 MHz to 525 MHz, and Setup 2 for 10 Hz to 20 MHz.

**Specification:** 50  $\Omega$ : 10 MHz - 525 MHz, 25 mV rms  
1 M  $\Omega$ : 10 Hz - 80 MHz, 25 mV rms

**Description:** The counter is set to the 10 MHz - 525 MHz range, 50  $\Omega$  impedance, and a 25 mV rms ( $-19.3$  dBm) signal is applied to Input 2 as shown in *Figure C-1*. The test generator is set to selected frequencies and the 5361B is checked for proper

counting. The counter is next set for 1M $\Omega$  impedance, a 25 mV rms (–19.3 dBm) 80 MHz signal is applied to INPUT 2 through a 50  $\Omega$  feedthrough, and the counter is checked for proper counting. The test setup is changed to Setup 2 to test the 10 Hz - 20 MHz range as shown in Figure C-2.

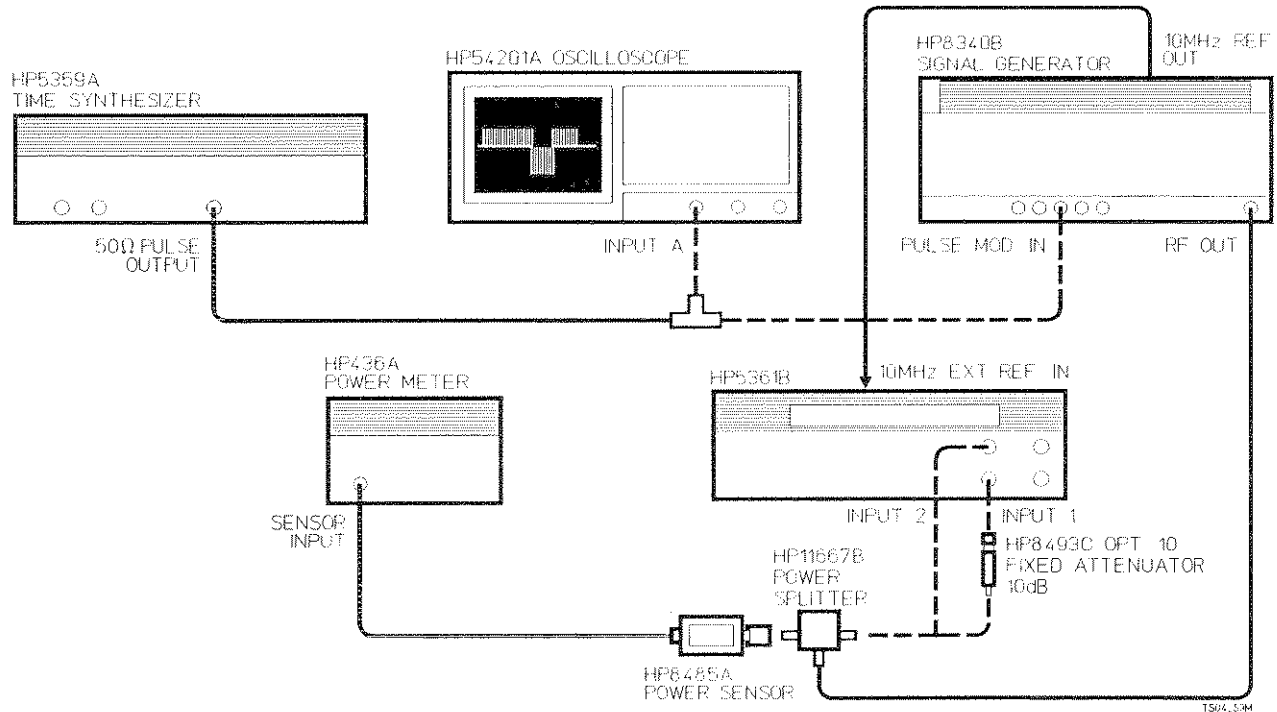

Figure C-1. Setup 1: CW/Pulse, 10 MHz - 26.5 MHz

1. Set the counter to the 10 MHz - 525 MHz range, 50  $\Omega$  impedance, by pressing the 50  $\Omega$  key.
2. Set the 8340B to 50 MHz and an output level of 25 mV rms (–19.3 dBm) as measured on the 436A Power Meter. Measure actual sensitivity and verify that the 5361B counts properly at 50 MHz, 100 MHz, 250 MHz, and 525 MHz. Enter the results in the Operation Verification Record (Table C-2).
3. Insert a 50  $\Omega$  feedthrough between the 11667B power splitter and INPUT 2 of the counter. Press the 1M  $\Omega$  key on the counter to select the 1M  $\Omega$  impedance, 10 Hz - 80 MHz input.
4. Set the 8340B to 80 MHz and a level of 25 mV rms (–19.3 dBm) as measured on the 436A Power Meter.
5. Verify that the 5361B counts properly at 80 MHz at 25 mV rms, and enter the result in the Operation Verification Record.

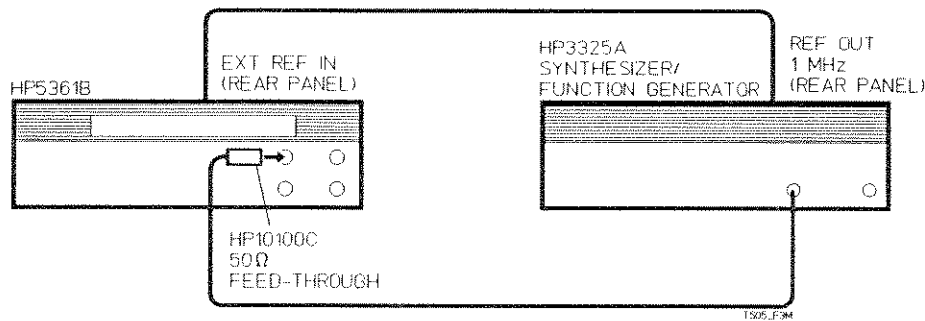

Figure C-2. Setup 2: INPUT 2, 10 Hz - 20 MHz

6. 5361B settings are the same as in the 80 MHz test (INPUT 2, 1M  $\Omega$ ).
7. Connect the 3325A to INPUT 2 of the counter via a 50  $\Omega$  feedthrough. Set the 3325A for an output of 25 mV rms ( $-19.3$  dBm) at 10 Hz.
8. Verify that the counter counts properly at 10 Hz, 50 kHz, 1 MHz, 10 MHz, and 20 MHz. Enter results in the Operation Verification Record.

### INPUT 1, 500 MHz - MAX GHz CW Input Sensitivity Test

The following procedure checks the input sensitivity of input 1 for CW signals.

**Specifications:** Refer to *Table C-3*, Operation Verification Record, on page C-15 for CW input sensitivity specifications.

**Description:** The counter is set to the 500 MHz - MAX GHz range and the appropriate input signal is applied to INPUT 1 as shown in *Figure C-1*. The generator is set to various frequencies/levels and the actual sensitivity of the HP 5361B is then measured.

1. Set the counter to INPUT 1, Automatic mode by pressing the AUTO key.
2. Connect the equipment as shown in *Figure C-1* (INPUT 1 path). Do not install the 10 dB attenuator pad for CW measurement.
3. Set the 8340B to 500 MHz,  $-28$  dBm ( $-20$  dBm for Opt. 026/040), as measured on the 436A.

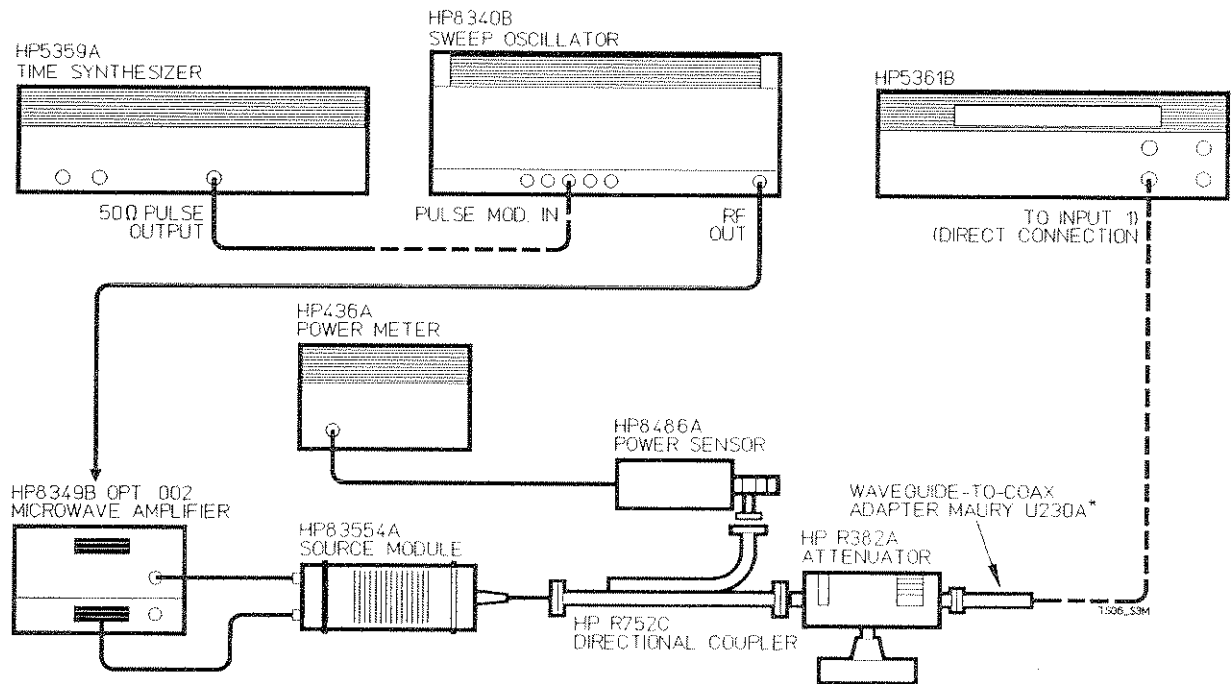

\* AVAILABLE FROM: MAURY MICROWAVE CORPORATION, 8610 HELMS AVENUE, CUCAMONGA, CA 91730.

Figure C-3. Setup 3: CW/Pulse 26.5 MHz - 40 GHz

4. Measure the actual sensitivity at 500 MHz, 1 GHz, 5 GHz, and 12.4 GHz. (Verify the signal level with the 436A Power Meter at each of these frequencies.) Enter the actual sensitivity result in the Operation Verification Record.
5. Set the 8340B to 18 GHz, -23 dBm (-20 dBm for Opt. 026/040), as measured on the 436A.
6. Measure the actual sensitivity at 18 GHz and 20 GHz. (Verify the signal level with the 436A Power Meter at each of these frequencies.) Enter the actual sensitivity result in the Operation Verification Record.
7. If the counter under test has option 026/040 installed, measure the actual sensitivity at 22 GHz and 26.5 GHz. (Verify the signal level with the 436A Power meter at each of these frequencies.) Enter the actual sensitivity results in the Operation Verification Record.
8. If the counter under test has option 040 installed, continue with the following test steps and refer to Figure C-3. Connect the equipment as shown in Figure C-3. For CW measurements DO NOT pulse-modulate the 8340B with the HP 5359A.
9. Set the 5361B to INPUT 1, Automatic mode by pressing the AUTO key.



10. Measure the actual sensitivity at 30 GHz, 34 GHz, and 40 GHz as follows:
  - a. Set the 8340B to 15 GHz, and set the level for +17 dBm output from the 8349B Amplifier (as indicated on the 8349B front panel display).
  - b. Add attenuation by adjusting the R382A Precision Attenuator until the counter stops measuring, then decrease attenuation until the counter begins correct measurement.
  - c. Note the doubled frequency (30 GHz) power reading on the 436A, add +10 dB to the reading, and subtract the value of the R382A attenuator setting to obtain the sensitivity level of the counter.
  - d. Repeat the above steps at 34 GHz and 40 GHz (17 and 20 GHz input to the source module, respectively).
11. Enter the actual sensitivity result in the Operation Verification Record.

### INPUT 1, 500 MHz - MAX GHz Pulse Input Sensitivity Test

Peak pulse power cannot be directly read from a power meter. Therefore, the following pulsed RF amplitude power relationship is presented as an example of how to interpret pulsed RF power readings. Refer to *Figure C-4* for amplitude/time waveform relationship.

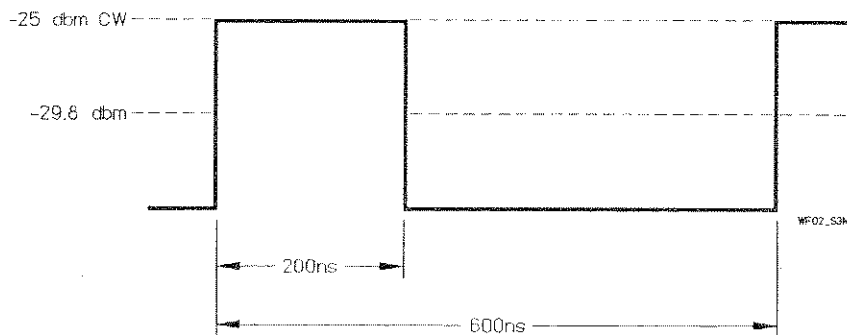

*Figure C-4. Pulsed RF Amplitude/Time Relationship*

For pulsed RF signals having the same peak power level as an equivalent CW signal, a power meter will average the pulse power level and display a lower reading. This must be taken into account to arrive at the required peak pulse power when setting up the source power level. The relationship is as follows:

$$\text{Power Meter Reading} = \text{Required Input Power} + 10 \log \frac{\text{Pulse Width}}{\text{Pulse Repetition Interval}}$$

The example in *Figure C-4* works out as follows:

$$\begin{aligned} \text{Power meter reading} &= -25 \text{ dBm} + 10 \log \frac{200}{600} \\ &= -25 \text{ dBm} + (-4.8 \text{ dBm}) \\ &= -29.8 \text{ dBm} \end{aligned}$$

-29.8 dBm is what the power meter will read if the above signal conditions are used.

**INPUT 1 PULSED RF SENSITIVITY TEST (500 MHz - MAX GHz)**

The following specifications, setup illustration, and test steps describe the INPUT 1 pulsed RF sensitivity for the HP 5361B within 500 MHz - MAX GHz frequency range. *Figure C-1* shows the test setup.

**Specifications:** Refer to *Table C-3, Operation Verification Record*, on page C-16 for pulse input sensitivity specifications.

1. Connect the 5359A output to the 8340B Pulse Modulation input.
2. Set the HP 5359A for a pulse width of 200 ns and a pulse period of 600 ns. Set the polarity to norm. and pos.; amplitude to midrange, and offset to off.
3. View the pulse on the oscilloscope to make final adjustment. The waveform time relationships should match those shown in *Figure C-4* with pulse amplitude at 2.0V nominal.
4. Set the HP 436A Power Meter for auto range (Range Hold button OUT and dBm Mode).
5. Set the HP 8340B Synthesizer to 500 MHz and output power level for a reading of -22.8 dBm (-14.8 dBm for Opt. 026/040) on the 436A power meter, remember that:

$$\begin{aligned} \text{Power meter reading} &= -28 \text{ dBm} + 10 \log \frac{200}{600} + 10 \text{ dB} \\ &= -28 \text{ dBm} + (-4.8 \text{ dBm}) + 10 \text{ dB} \\ &= -22.8 \text{ dBm} \end{aligned}$$

6. Power-up the HP 5361B counter and observe automatic selection/display of pulse mode and measurement.

7. Verify that the HP 5361B counts correctly at 500 MHz, 1 GHz, 5 GHz, and 12.4 GHz.

---

**NOTE**

---

*The count accuracy of the HP 5361B is shown in Graphs 2 and 3, Resolution and Gate Error, of the Appendix A Specifications for a 200 ns pulse when the counter is phase-locked to a house standard.*

---

8. Change the power level from  $-22.8$  dBm to  $-17.8$  dBm ( $-14.8$  dBm for Opt. 026/040) and verify that the HP 5361B counts correctly at 18 GHz and 20 GHz.
9. Enter the actual sensitivity results in the Operation and Verification Record.
10. If the counter under test has option 026/040 installed, measure the actual sensitivity at 22 GHz and 26.5 GHz and change the power level to  $-14.8$  dBm as measured with the 436A power meter.
11. Enter the actual sensitivity result in the Operation Verification Record.
12. If the counter under test has option 040 installed, refer to *Figure C-3* for the test setup.
13. Pulse modulate the 8340B with the output of the 5359A for a pulse width of 200 ns and a pulse period of 600 ns.
14. Set the polarity to NORM. and POS.; pulse amplitude to 2V and offset to OFF.
15. View the pulse on an oscilloscope to make final adjustment. The waveform time relationship should match that shown in *Figure C-4* with a pulse amplitude of 2V.
16. Set the counter to INPUT 1, Automatic mode by pressing the AUTO key.
17. Measure the actual sensitivity at 30 GHz, 34 GHz, and 40 GHz as follows:
  - a. Set the 8340B to 15 GHz, and set the level for a  $+17$  dBm output from the 8349B amplifier (as indicated on the 8349B front panel display).
  - b. Add attenuation by adjusting the R382A Precision Attenuator until the counter stops measuring, then decrease attenuation until the counter begins correct measurement.
  - c. Note the doubled frequency (30 GHz) power reading on the 436A, add  $+10$  dB to the reading, and subtract the value of the R382A attenuator setting to obtain the sensitivity level of the counter.

- d. Repeat the above steps at 34 GHz and 40 GHz (17 and 20 GHz input to the source module, respectively).
18. Enter the actual sensitivity result in the Operation Verification Record.

## HP-IB VERIFICATION

The program listed at the end of this appendix exercises the HP 5361B through various operating modes via the counter's HP-IB interface. If the counter successfully completes all phases of the verification program, there is a high probability that the HP-IB interface (A11 Assembly) is operating correctly. You'll need to pass all check points of the verification program. Refer to the *Figure C-5*.

This program is not intended to be an automated test system for operation verification of the entire counter, but rather an aid to verify that the HP-IB interface is handshaking properly, sending valid data to the controller, and controlling the counter properly. If the HP 5361B does not respond as described, refer to A11 HP-IB Interface Assembly troubleshooting in Section 5 of the Service manual.

To perform the verification, set up the HP 5361B, HP 9000 Series 200/300 Controller, and signal source as shown in *Figure C-5*. The program will function with any valid HP-IB address set for the counter. The first setup is for CW signal verification only and is used for program check points 12, 13, 14, and 15. The second setup is a minor variation of the CW setup that verifies pulse signal operation for program check point 16.



program on the disk, insert the diskette into the Controller, load the program "5361AB", and press RUN.

The program goes through 17 checkpoints, including a test to verify remote response at all legal addresses (Checkpoint 17). At the conclusion of each checkpoint, the operator is requested to enter the results of the current checkpoint. These results are stored and can be printed upon completion of the program. *Table C-2* is a sample of the results of the HP-IB Verification program. The actual printed results should be attached to the Operation Verification Record (*Table C-3*).

Various checkpoints throughout the program ask the operator to verify that the counter's OPEN annunciator is on, as well as other annunciators. Note that if a signal is present at the appropriate input, the OPEN annunciator should be flashing at a rate proportional to the sample rate.

*Table C-2. Sample HP-IB Verification Listing*

CHECKPOINT SUMMARY:		HP-IB VERIFICATION RESULTS:	
		CHECKPOINT	RESULTS
1	Remote, Local Lockout, Local	1	PASS
2	Self Check ('TEST?')	2	PASS
3	'DISPLAY'	3	PASS
4	'INIT' & 'RESET'	4	PASS
5	'REF' & 'OVEN'	5	PASS
6	'ERR?'	6	PASS
7	'SET' & 'SET?'	7	NOT PERFORMED
8	'LOWZ' & 'HIGHZ'	8	PASS
9	'SAMPLE' & 'TRIGGER'	9	PASS
10	'RESOL' & 'HIRESOL'	10	PASS
11	'OFFSET', 'SCALE' & 'SMOOTH'	11	PASS
12	'AUTO' & 'MANUAL'	12	PASS
13	'FMRATE'	13	PASS
14	'SRQMASK'	14	PASS
15	'DUMP'	15	PASS
16	'PULSE MEASUREMENT'	16	NOT PERFORMED
17	CHECK ALL ADDRESSES	17	PASS

Table C-3. Operation Verification Record

<b>Hewlett-Packard Model 5361B</b> <b>Pulse/CW Microwave Counter</b>		Repair/Work Order No. _____		
Serial Number: _____		Temperature: _____		
Test Performed By: _____		Relative Humidity: _____		
Date: _____		Post Calibration Test: <input type="checkbox"/>		
Notes: _____		Pre Calibration Test: <input type="checkbox"/>		
TEST	TEST RESULTS	SPECIFICATION		
Power-Up Self Test INPUT 2, Counting Check	Pass ___ Fail ___ Pass ___ Fail ___			
INPUT 2, 10 Hz-525 MHz Input Sensitivity Test (50 Ω/1M Ω):  50 Ω:      50 MHz 100 MHz 250 MHz 525 MHz  1M Ω:     10 Hz 50 kHz 1 MHz 10 MHz 20 MHz 80 MHz	(record actual sensitivity)  _____ _____ _____ _____ _____ _____ _____ _____ _____	25 mV rms (-19.3 dBm)		
INPUT 1, 500 MHz - MAX GHz CW Input Sensitivity Test:  500 MHz 1 GHz 5 GHz 12.4 GHz  18 GHz 20 GHz 22 GHz 26.5 GHz  30 GHz 34 GHz 40 GHz	_____ _____ _____ _____ _____ _____ _____ _____ _____	20 GHz  -28 dBm  -23 dBm -23 dBm  N/A	26.5 GHz (Opt. 026)  -20 dBm  -20 dBm	40 GHz (Opt. 040)  -20 dBm  -20 dBm  -18.7 dBm -17.2 dBm -15 dBm
HP-IB Verification	Pass ___ Fail ___			

Table C-3. Operation Verification Record (Continued)

Hewlett-Packard Model 5361B Pulse/CW Microwave Counter				
TEST	TEST RESULTS	SPECIFICATION		
		20 GHz	26.5 GHz (Opt. 026)	40 GHz (Opt. 040)
INPUT 1, 500 MHz - MAX GHz Pulse Input Sensitivity Test:				
500 MHz	_____	-28 dBm	-20 dBm	-20 dBm
1 GHz	_____			
5 GHz	_____			
12.4 GHz	_____			
18 GHz	_____	-23 dBm		
20 GHz	_____	-23 dBm		
22 GHz	_____			
26.5 GHz	_____		-20 dBm	-20 dBm
30 GHz	_____	N/A		-18.7 dBm
34 GHz	_____			-17.2 dBm
40 GHz	_____			-15 dBm





Table C-4. Performance Test Record (Page 2 of 2)

Hewlett-Packard Model 5361B Pulse/CW Microwave Counter				
TEST	TEST RESULTS	SPECIFICATION		
<b>INPUT 1, 500MHz - MAX GHz</b> Pulse Input Sensitivity Test:		<b>20 GHz</b>	<b>26.5 GHz (Opt. 026)</b>	<b>40 GHz (Opt. 040)</b>
500 MHz	_____	-28 dBm	-20 dBm	-20 dBm
1 GHz	_____			
2.5 GHz	_____			
5 GHz	_____			
10 GHz	_____			
12.4 GHz	_____			
16 GHz	_____	-23 dBm		
18 GHz	_____			
19 GHz	_____			
20 GHz	_____	-23 dBm		
22 GHz	_____			
24 GHz	_____			
26.5 GHz	_____		-20 dBm	-20 dBm
30 GHz	_____	N/A		-18.7 dBm
34 GHz	_____			-17.2 dBm
40 GHz	_____			-15 dBm
<b>Pulse Frequency Profile</b>	Pass ___ Fail ___			
<b>FM Rate</b> Normal Rate (1 kHz)	Pass ___ Fail ___			
<b>Tolerance:</b> Low Rate (45 Hz)	Pass ___ Fail ___			
Trafck Rate (300 kHz)	Pass ___ Fail ___			
<b>INPUT 1, Pulse Width/Repetition</b> <b>Frequency test:</b>				
Auto Mode, 100 ns, 2 MHz PRF	Pass ___ Fail ___			
Manual Mode, 90 ns, 2 MHz PRF	Pass ___ Fail ___			
Autol Mode, 2 ms, 50 Hz PRF	Pass ___ Fail ___			
<b>External Arm/Gate tests:</b>				
External Arm mode	Pass ___ Fail ___			
External Gate mode	Pass ___ Fail ___			
<b>HP-IB</b> <b>Verification</b>	Pass ___ Fail ___			

## PERFORMANCE TEST PROCEDURES

### INPUT 2, 10 Hz - 525 MHz CW Input Sensitivity Test

The following test is in two parts, Setup 1 for 50 MHz to 525 MHz, and Setup 2 for 10 Hz to 10 MHz.

**Specification:** 50  $\Omega$ : 10 MHz - 525 MHz, 25 mV rms  
1 M  $\Omega$ : 10 Hz - 80 MHz, 25 mV rms

**Description:** The counter is set to the 10 MHz - 525 MHz range, 50  $\Omega$  impedance, and a 25 mV rms (-19.3 dBm) signal is applied to Input 2 as shown in *Figure C-1*. The test generator is set to selected frequencies and the 5361B is checked for proper counting. The counter is next set for 1M $\Omega$  impedance, a 25 mV rms (-19.3 dBm) 80 MHz signal is applied to INPUT 2 through a 50  $\Omega$  feedthrough, and the counter is checked for proper counting. The test setup is changed to Setup 2 to test the 10 Hz - 20 MHz range as shown in *Figure C-2*.

1. Set the counter to the 10 MHz - 525 MHz range, 50  $\Omega$  impedance, by pressing the 50  $\Omega$  key.
2. Set the 8340B to 50 MHz and an output level of 25 mV rms (-19.3 dBm) as measured on the 436A Power Meter. Measure actual sensitivity and verify that the 5361B counts properly at 50 MHz, 100 MHz, 200 MHz, 400 MHz, and 525 MHz. Enter the results in the Performance Test Record (*Table C-4*).
3. Insert a 50  $\Omega$  feedthrough between the 11667B power splitter and INPUT 2 of the counter. Press the 1M  $\Omega$  key on the counter to select the 1M  $\Omega$  impedance, 10 Hz - 80 MHz input.
4. Set the 8340B to 80 MHz and a level of 25 mV rms (-19.3 dBm) as measured on the 436A Power Meter.
5. Verify that the 5361B properly counts 50 MHz and 80 MHz at 25 mV rms, and enter the result in the Performance Test Record.

Change to test setup 2 to check the 10 Hz-20 MHz range with the following procedure.

1. 5361B settings are the same as in the 50 MHz and 80 MHz test (INPUT 2, 1M  $\Omega$ ).
2. Connect the 3325A to INPUT 2 of the counter via a 50  $\Omega$  feedthrough. Set the 3325A for an output of 25 mV rms (-19.3 dBm) at 10 Hz.
3. Verify that the counter counts properly at 10 Hz, 1 kHz, 500 kHz, 1 MHz, and 10 MHz. Enter results in the Performance Test Record.

## INPUT 1, 500 MHz - MAX GHz CW Input Sensitivity Test

The following procedure checks the input sensitivity of input 1 for CW signals.

**Specifications:** Refer to *Table C-4, Performance Test Record*, on page C-17 for CW input sensitivity specifications.

**Description:** The counter is set to the 500 MHz - MAX GHz range and the appropriate input signal is applied to INPUT 1 as shown in *Figure C-1*. The generator is set to various frequencies/levels and the actual sensitivity of the HP 5361B is then measured.

1. Set the counter to INPUT 1, Automatic mode by pressing the AUTO key.
2. Connect the equipment as shown in *Figure C-1* (INPUT 1 path). Do not install the 10 dB attenuator pad for CW measurement.
3. Set the 8340B to 500 MHz, -28 dBm (-20 dBm for Opt. 026/040), as measured on the 436A.
4. Measure the actual sensitivity at 500 MHz, 1 GHz, 2.5 GHz, 5 GHz, 10 GHz, and 12.4 GHz. (Verify the signal level with the 436A Power Meter at each of these frequencies.) Enter the actual sensitivity result in the Performance Test Record.
5. Set the 8340B to 16 GHz, -23 dBm (-20 dBm for Opt. 026/040), as measured on the 436A.
6. Measure also the actual sensitivity at 18 GHz, 19 GHz, and 20 GHz. (Verify the signal level with the 436A Power Meter at each of these frequencies.) Enter the actual sensitivity result in the Performance Test Record.
7. If the counter under test has option 026/040 installed, measure the actual sensitivity at 22 GHz, 24 GHz, and 26.5 GHz. (Verify the signal level with the 436A Power meter at each of these frequencies.) Enter the actual sensitivity results in the Performance Test Record.
8. If the counter under test has option 040 installed, continue with the following test steps. (Refer to *Figure C-3*.) Connect the equipment as shown in *Figure C-3*. For CW measurements DO NOT pulse-modulate the 8340B.
9. Set the 5361B to INPUT 1, Automatic mode by pressing the AUTO key.

10. Measure the actual sensitivity at 30 GHz, 34 GHz, and 40 GHz as follows:
  - a. Set the 8340B to 15 GHz, and set the level for +17 dBm output from the 8349B Amplifier (as indicated on the 8349B front panel display).
  - b. Add attenuation by adjusting the R382A Precision Attenuator until the counter stops measuring, then decrease attenuation until the counter begins correct measurement.
  - c. Note the doubled frequency (30 GHz) power reading on the 436A, add +10 dB to the reading, and subtract the value of the R382A attenuator setting to obtain the sensitivity level of the counter.
  - d. Repeat the above steps at 34 GHz and 40 GHz (17 and 20 GHz input to the source module, respectively).
  
11. Enter the actual sensitivity result in the Performance Test Record.

### INPUT 1, 500 MHz - MAX GHz Pulse Input Sensitivity Test

Peak pulse power cannot be directly read from a power meter. Therefore, the following pulsed RF amplitude power relationship is presented as an example of how to interpret pulsed RF power readings. Refer to *Figure C-4* for amplitude/time waveform relationship.

For pulsed RF signals having the same peak power level as an equivalent CW signal, a power meter will average the pulse power level and display a lower reading. This must be taken into account to arrive at the required peak pulse power when setting up the source power level. The relationship is as follows:

$$\text{Power Meter Reading} = \text{Required Input Power} + 10 \log \frac{\text{Pulse Width}}{\text{Pulse Repetition Interval}}$$

The example in *Figure C-4* works out as follows:

$$\begin{aligned} \text{Power meter reading} &= -25 \text{ dBm} + 10 \log \frac{200}{600} \\ &= -25 \text{ dBm} + (-4.8 \text{ dBm}) \\ &= -29.8 \text{ dBm} \end{aligned}$$

-29.8 dBm is what the power meter will read if the above signal conditions are used.

**INPUT 1 PULSED RF SENSITIVITY TEST (500 MHz - MAX GHz)**

The following specifications, setup illustration, and test steps describe the INPUT 1 pulsed RF sensitivity for the HP 5361B within 500 MHz - MAX GHz frequency range. *Figure C-1* shows the test setup.

**Specifications:** Refer to *Table C-4, Performance Test Record*, on page C-18 for CW input sensitivity specifications.

1. Connect the 5359A output to the 8340B Pulse Modulation input.
2. Set the HP 5359A for a pulse width of 200 ns and a pulse period of 600 ns. Set the polarity to norm. and pos.; amplitude to midrange, and offset to off.
3. View the pulse on the oscilloscope to make final adjustment. The waveform time relationships should match those shown in *Figure C-4* with pulse amplitude at 2.0V nominal.
4. Set the HP 436A Power Meter for auto range (Range Hold button OUT and dBm Mode).
5. Set the HP 8340B Synthesizer to 500 MHz and output power level for a reading of -22.8 dBm (-14.8 dBm for Opt. 026/040) on the 436A power meter, remember that:

$$\begin{aligned}
 \text{Power meter reading} &= -28 \text{ dBm} + 10 \log \frac{200}{600} + 10 \text{ dB} \\
 &= -28 \text{ dBm} + (-4.8 \text{ dBm}) + 10 \text{ dB} \\
 &= -22.8 \text{ dBm}
 \end{aligned}$$

6. Power-up the HP 5361B counter and observe automatic selection/display of pulse mode and measurement.
7. Verify that the HP 5361B counts correctly at 500 MHz, 1 GHz, 2.5 GHz, 5 GHz, 10 GHz, and 12.4 GHz.

**NOTE**

---

*The count accuracy of the HP 5361B is shown in Graphs 2 and 3, Resolution and Gate Error, of the Appendix A Specifications for a 200 ns pulse when the counter is phase-locked to a house standard.*

---

8. Change the power level from  $-22.8$  dBm ( $-14.8$  dBm for Opt. 026/040) to  $-17.8$  dBm and verify that the HP 5361B counts correctly at 16 GHz, 18 GHz, 19 GHz, and 20 GHz.
9. Enter the actual sensitivity results in the Performance Test Record.
10. If the counter under test has option 026/040 installed, measure the actual sensitivity at 22 GHz, 24 GHz, and 26.5 GHz and change the power level to  $-14.8$  dBm as measured with the 436A power meter.
11. Enter the actual sensitivity result in the Performance Test Record.
12. If the counter under test has option 040 installed, refer to *Figure C-3* for the test setup.
13. Pulse modulate the 8340B with the output of the 5359A for a pulse width of 200 ns and a pulse period of 600 ns.
14. Set the polarity to NORM. and POS.; pulse amplitude to 2V and offset to OFF.
15. View the pulse on an oscilloscope to make final adjustment. The waveform time relationship should match that shown in *Figure C-4* with a pulse amplitude of 2V.
16. Set the counter to INPUT 1, Automatic mode by pressing the AUTO key.
17. Measure the actual sensitivity at 30 GHz, 34 GHz, and 40 GHz as follows:
  - a. Set the 8340B to 15 GHz, and set the level for a  $+17$  dBm output from the 8349B amplifier (as indicated on the 8349B front panel display).
  - b. Add attenuation by adjusting the R382A Precision Attenuator until the counter stops measuring, then decrease attenuation until the counter begins correct measurement.
  - c. Note the doubled frequency (30 GHz) power reading on the 436A, add  $+10$  dB to the reading, and subtract the value of the R382A attenuator setting to obtain the sensitivity level of the counter.
  - d. Repeat the above steps at 34 GHz and 40 GHz (17 and 20 GHz input to the source module, respectively).
18. Enter the actual sensitivity result in the Performance Test Record.

## Pulse Frequency Profile

**Specifications:** Pass/Fail

**Description:** The Profile function for pulse frequency is exercised and evaluated for Pass/Fail.

**Procedure:** Refer to the procedure below, and use the pulse signal setup for the previous pulse performance sensitivity test at 12.4 GHz.

1. Set up the 8340B and 5359A as shown in *Figure C-1*.
2. Set the 8340B for a frequency of 12.4 GHz and the 5359A for a pulse width of 200 ns with a pulse period of 600 ns as in the previous pulse sensitivity test.
3. Set the sample rate to HOLD by pressing SET/ENTER, SAMPLE RATE, DEC, keys until "HOLD" is displayed, then press SET/ENTER.
4. Connect a cable (model 10833A, 1 metre) from the HP-IB connector on the rear of the 5361B to one of the compatible printers.
5. Set the printer to Listen Only Mode. This is done by setting the HP-IB address switch to "Listen Always" on the back of the printer, then cycling ac power.
6. Now set the 5361B to Talk Only by setting HP-IB address to 31. This can be done through the front panel using the key sequence SET/ENTER, HP-IB Address, 3, 1, SET/ENTER.
7. Press the FREQUENCY/PROFILE key once.
8. When you want to begin the profiling process, press the TRIGGER key and observe the printer for output of a hardcopy profile plot.
9. If the printer produces a hardcopy profile plot, then the counter has passed this test.



## FM Tolerance Test (CW Only)

**Specifications:** 20 MHz maximum peak-to-peak deviation  
12 MHz maximum peak-to-peak deviation for Opt. 040.

**Description:** The FM peak-to-peak deviation specification is the worst case FM deviation that can be present on a carrier that the instrument can acquire and count. The counter averages out the deviations and displays a carrier frequency. In addition, the HP 5361B offers a choice of FM rate modes. This test will verify that the counter performs properly in all three modes. Test setup is shown in *Figure C-6*.

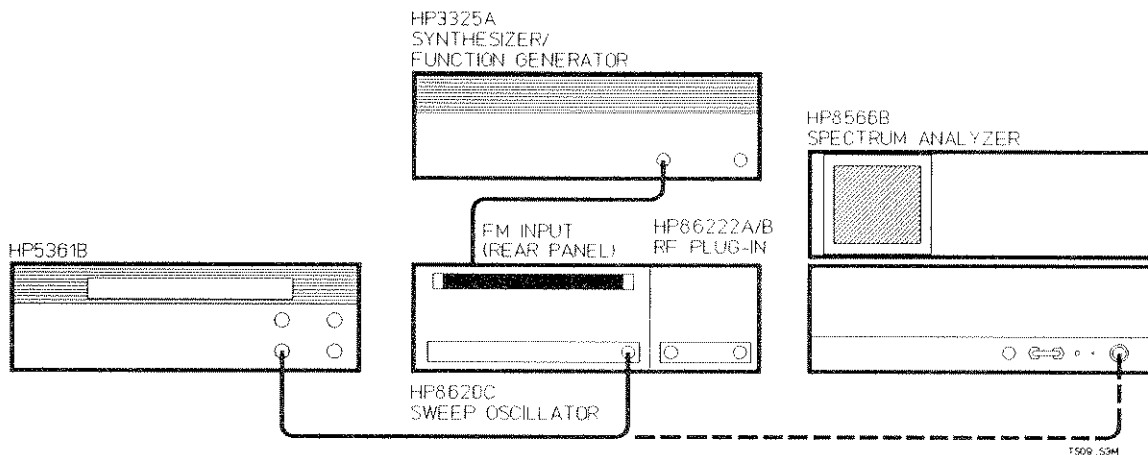

Figure C-6. Setup: FM Tolerance Test

1. Set the 8620C to 1 GHz.
2. Set the 86222A/B to -5 dBm.
3. Set the 3325A to 1 kHz.
4. Set the output amplitude of the 3325A to achieve a peak-to-peak width of 20 MHz. To set the amplitude, use the 8565A Spectrum Analyzer to verify the width of the FM deviation at the output of the 86222A/B.
5. Verify that the counter acquires and correctly counts the modulated input. Enter the result in the Performance Test Record.
6. Set the 5361B to extended function 6 by pressing the following key sequence: SET/ENTER, EXTEND FUNCT, 6, SET/ENTER. The counter will display the harmonic number, including the fractional portion.

7. Verify that the displayed fractional portion does not deviate more than 0.30 from the integer value. For example, a harmonic number of 3 should not deviate to less than 2.70 or greater than 3.30.
8. Set the 3325A to 45 Hz.
9. Set the 5361B to Low FM Rate by pressing the FM RATE/TRACK key. The LOW annunciator will turn on.
10. Verify that the fractional portion of the harmonic number still does not deviate more than 0.30 from the integer value.
11. Press the RESET/LOCAL key and verify that the displayed count matches that of the normal FM rate mode (step 5). Enter the result in the Performance Test Record.
12. Set the 3325A to 300 kHz.
13. Set the 5361B to Track rate by pressing the FM RATE/TRACK key. The TRACK annunciator will turn on.
14. Set the 5361B to extended function 6 by pressing the EXTEND FUNCT key.
15. Verify that the fractional portion of the harmonic number still does not deviate more than 0.30 from the integer value.
16. Press the RESET/LOCAL key and verify that the displayed count matches that of the normal FM rate mode (step 5).
17. Enter the results in the Performance Test Record.

If the counter fails the FM tolerance test, refer to Section 2, Adjustments in the Service manual, and verify the A6 IF Amplifier/Detector Assembly adjustments. If the adjustments are correct and the counter continues to fail, refer to the troubleshooting information in Section 5 in the Service manual for procedures to diagnose and repair the following assemblies:

A6 IF Amplifier/Detector Assembly  
Microwave Module (A12 Microwave Assembly/U1 Sampler)

## INPUT 1 Pulse Width/Repetition Frequency Test

The following test is in three parts, test one for 100 ns pulse width, test two for manual mode, 90 ns, 2 MHz PRF, and test three for auto mode, 2 ms, 50 Hz PRF.

**Specifications:** Test 1 - Auto Mode, 100 ns, 2 MHz PRF: Pass/Fail  
 Test 2 - Manual Mode, 90 ns, 2 MHz PRF: Pass/Fail  
 Test 3 - Auto Mode, 2 ms, 50 Hz PRF: Pass/Fail

**Description:** The counter is set to the 500 MHz - MAX GHz range and the appropriate input signal is applied to INPUT 1 as shown in *Figure C-1*. The synthesized signal generator is set to 10 GHz, and the actual sensitivity of the 5361B is observed for the three pulse mode test cases listed above.

### AUTO MODE, 100 ns, 2 MHz PRF

The referenced setup illustration and test steps describe the INPUT 1, 100 ns pulse width test for the HP 5361B 10 GHz. *Figure C-1* shows the test setup.

1. Configure the HP 5359A to output a square wave with a 100 ns width, 500 ns pulse period, and amplitude of 2.0 volts. (Refer to *Figure C-4* for a general profile of the waveform.)
2. Set the power switch of the HP 5361B to ON, enable Auto mode, and select 1 kHz resolution.
3. Set the HP 436A power meter for auto range (Range Hold button out) and dBm mode.
4. Set the HP 8340B synthesized signal generator to 10 GHz and output power level to for a power meter (436A) reading of -25 dBm:

$$\begin{aligned} \text{Power meter reading} &= -28 \text{ dBm} + 10 \log \frac{100}{500} + 10 \text{ dB} \\ &= -28 \text{ dBm} + (-7 \text{ dBm}) + 10 \text{ dB} \\ &= -25 \text{ dBm} \end{aligned}$$

5. Verify that the 5361B counts correctly at 10 GHz to the accuracy shown in Graph 1 of the Appendix A Specifications with a 100 ns pulse.

**NOTE**

The count accuracy of the HP 5361B is shown in Graphs 2 and 3, Resolution and Gate Error, of the Appendix A Specifications when the counter is phase-locked to a house standard.

6. Record the test results on the Performance Test Record.

**MANUAL MODE, 90 ns, 2 MHz PRF**

The referenced setup illustration and test steps describe the INPUT 1, 90 ns pulse width test for the HP 5361B 10 GHz. Figure C-1 shows the test setup.

1. Configure the HP 5359A to output a square wave with a 90 ns width, 500 ns pulse period, and amplitude of 2.0 volts. (Refer to Figure C-4 for a general profile of the waveform.)
2. Set the power switch of the HP 5361B to ON, enable Auto mode, and select 1 kHz resolution.
3. Set the HP 436A power meter for auto range (Range Hold button out) and dBm mode.
4. Set the HP 8340B synthesized signal generator to 10 GHz and output power level to for a power meter (436A) reading of -25.45 dBm:

$$\begin{aligned}\text{Power meter reading} &= -28 \text{ dBm} + 10 \log \frac{90}{500} + 10 \text{ dB} \\ &= -28 \text{ dBm} + (-7.45 \text{ dBm}) + 10 \text{ dB} \\ &= -25.45 \text{ dBm}\end{aligned}$$

5. Set the counter to Manual mode with a center frequency of 10 GHz by pressing the following keys: SET/ENTER, MANUAL, 1, 0, GHz, SET/ENTER.
6. Set the counter to extended function 93 by pressing the following keys: SET/ENTER, EXTEND FUNCT, 9, 3, SET/ENTER.
7. Verify that the 5361B counts correctly at 10 GHz to the accuracy shown in Graph 1 of the Appendix A Specifications.

**NOTE**

The count accuracy of the HP 5361B is shown in Graphs 2 and 3, Resolution and Gate Error, of the Appendix A Specifications when the counter is phase-locked to a house standard.

8. Record the test results on the Performance Test Record.
9. Turn-off extended function 93 before conducting any further tests by pressing SET/ENTER, EXTENDED FUNCTION, 9, 3, SET/ENTER.

**AUTO MODE, 2 ms, 50 Hz PRF**

The referenced setup illustration and test steps describe the INPUT 1, Auto mode 50 Hz PRF test for the HP 5361B at 10 GHz. *Figure C-1* shows the test setup.

1. Configure the HP 5359A to output a square wave with a 2 ms width, 20 ms pulse period, and amplitude of 2.0 volts. (Refer to *Figure C-4* for a general profile of the waveform.)
2. Set the HP 5361B to 100 Hz resolution and enable Auto mode.
3. Set the HP 436A power meter for auto range (Range Hold button out) and dBm mode.
4. Set the HP 8340B synthesized signal generator to 10 GHz and output power level for a power meter (436A) reading of -28 dBm:

$$\begin{aligned}
 \text{Power meter reading} &= -28 \text{ dBm} + 10 \log \frac{2 \text{ ms}}{20 \text{ ms}} + 10 \text{ dB} \\
 &= -28 \text{ dBm} + (-10 \text{ dBm}) + 10 \text{ dB} \\
 &= -38 \text{ dBm} + 10 \text{ dB} \\
 &= -28 \text{ dBm}
 \end{aligned}$$

5. Verify the following pulse envelope parameters with the 5361B:

PRF        = 50 Hz  
 PRI        = 20 ms  
 OFFTIME = 18 ms  
 PW        = 2 ms

6. Verify that the 5361B counts correctly at 10 GHz to the accuracy shown in Graph 1 of the Appendix A Specifications for a 2 ms pulse.

**NOTE**

The count accuracy of the HP 5361B is shown in Graphs 2 and 3, Resolution and Gate Error, of the Appendix A Specifications when the counter is phase-locked to a house standard.

- Record the test results on the Performance Test Record.

**External Gate/Arm In Test**

The following specifications, setup illustration, and test steps describe the External Gate/Arm In test for the HP 5361B at 10 GHz.

**Specification:** Pass/Fail

**Description:** This test checks for proper operation of the external front panel Gate/Arm input. An active low TTL signal edge is applied at the front panel GATE/ARM IN connector. This enables the counter to make a measurement on the next RF pulse burst. The arming active-low edge must occur at least 50 ns prior to the pulse burst of interest. The counter must correctly count the 10 GHz carrier at the specified power. Figure C-7 shows the test waveforms.

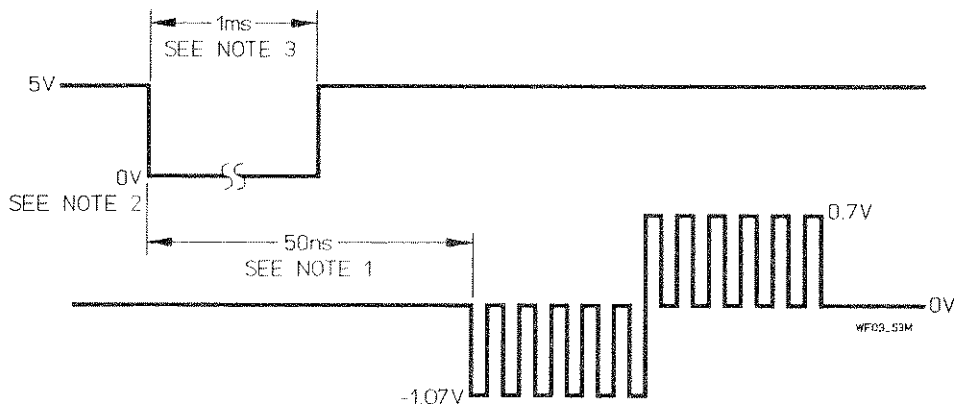

NOTES

- ADJUST GATE PULSE FALLING EDGE NO CLOSER THAN 50ns AHEAD OF PULSE SIGNAL.
- ADJUST 8012B OFFSET VERNIER TO ENSURE THAT THE BASELINE OF THE SQUARE WAVE IS AT 0 VOLTS.
- ADJUST 8012B PULSE WIDTH VERNIER FOR PULSE WIDTH OF 1ms.
- TIME DIMENSIONS ARE NOT DRAWN TO SCALE.

Figure C-7. External Arm/Gate Mode Test Waveforms

The following procedure describes the External Arm Mode test for the HP 5361B at 10 GHz. *Figure C-8* shows the test setup.

1. Set the HP 5359A for a pulse width of 2 ms, 1 ns delay, with the external trigger level at +2 volts. Set the polarity to norm. and pos.; amplitude to 2.5 volts, and offset to off.
2. Set the following parameters on the 8012B pulse generator:
  - a. PULSE PERIOD . . . . . 10 ms - 1 ms
  - b. PULSE PERIOD VERNIER . . . . . adjust for 20 ms PRI
  - c. PULSE SWITCH . . . . . Normal
  - d. DELAY . . . . . .0.1 ms - 10 ms
  - e. PULSE WIDTH SWITCH . . . . . .0.1 ms - 10 ms
  - f. PULSE WIDTH VERNIER . . . . . adjust for 1 ms (see *Figure C-7*)
  - g. TRANSITION TIME . . . . . N/A
  - h. LEADING AND TRAILING EDGES . . . . . .ccw
  - i. AMPLITUDE SWITCH . . . . . 5V (Max)
  - j. AMPLITUDE VERNIER . . . . . Max
  - k. OFFSET SWITCH . . . . . .ON
  - l. PULSE POLARITY . . . . . Negative
  - m. OUTPUT SWITCH . . . . . Normal
  - n. INT. LOAD . . . . . .In
3. Ensure that the above signal parameters are correct by observing the waveform on an oscilloscope with 50  $\Omega$  termination for final adjustment. The signal should appear as shown in the top waveform of *Figure C-7* with a 5 volt amplitude.
4. The most critical setting is the offset vernier. Make this adjustment so that the base line of the square wave is at 0 V. To move the pulse signal left or right, adjust the 8012B delay vernier as needed.
5. Set the HP 436A Power Meter for auto range (Range Hold button OUT and dBm Mode).
6. Set the HP 8340B Synthesizer to 10 GHz and output power level for a reading of -20 dBm on the 436A power meter.
7. Power-up the HP 5361B counter, select 1 kHz resolution, and set the gate mode to Internal. If the counter is not energized from the STBY state, allow at least 30 minutes for complete warm-up.
8. Adjust the 8012B pulse delay vernier so the oscilloscope display conforms to the waveform shown in *Figure C-7* (When using an analog scope, place the vertical display in chop position and internal trigger in channel B. Channel A - dc coupling, channel B - ac coupling.)

9. Verify the following pulse envelope parameters with the HP 5361B while set to Internal gate mode:

PRF       = 50 Hz  
PRI       = 20 ms  
OFFTIME = 18 ms  
PW        = 2 ms

(Make the necessary adjustments to either the 5359A or 8012B to obtain the above values. Pulse width can be adjusted from the 5359A. PRI can be adjusted from the 8012B pulse period Vernier.)

10. Verify that the HP 5361B counts correctly at 10 GHz while set to Internal gate mode.
11. Set the gate mode to ARM and verify only that the HP 5361B counts the RF frequency correctly at 10 GHz while in external ARM gate mode.

(Review *Figure C-7* carefully and make additional fine tune adjustments to the offset and delay vernier for proper counter operation in the external ARM gate mode.)

12. Record the results on the Performance Test Record.

#### NOTE

*The count accuracy of the HP 5361B is shown in Graphs 2 and 3, Resolution and Gate Error, of the Appendix A Specifications for a 200 ns Pulse when the counter is phase-locked to a house standard.*

## External Gate Mode Test

The following specifications, setup illustration, and test steps describe the External Gate mode test for the HP 5361B at 10 GHz.

**Specification:** Pass/Fail

**Description:** This test checks for proper operation of the External Gate mode. An active low TTL signal is applied at the front panel GATE/ARM IN connector from a pulse generator. The duration of this signal determines when the counter will make a measurement on the input RF pulse. The counter must correctly count the 10 GHz carrier at the specified power and display gate position relative to pulse onset/end via the front panel SCOPE-VIEW output.

The following procedure describes the External Gate Mode test for the HP 5361B at 10 GHz. *Figure C-8* shows the test setup.



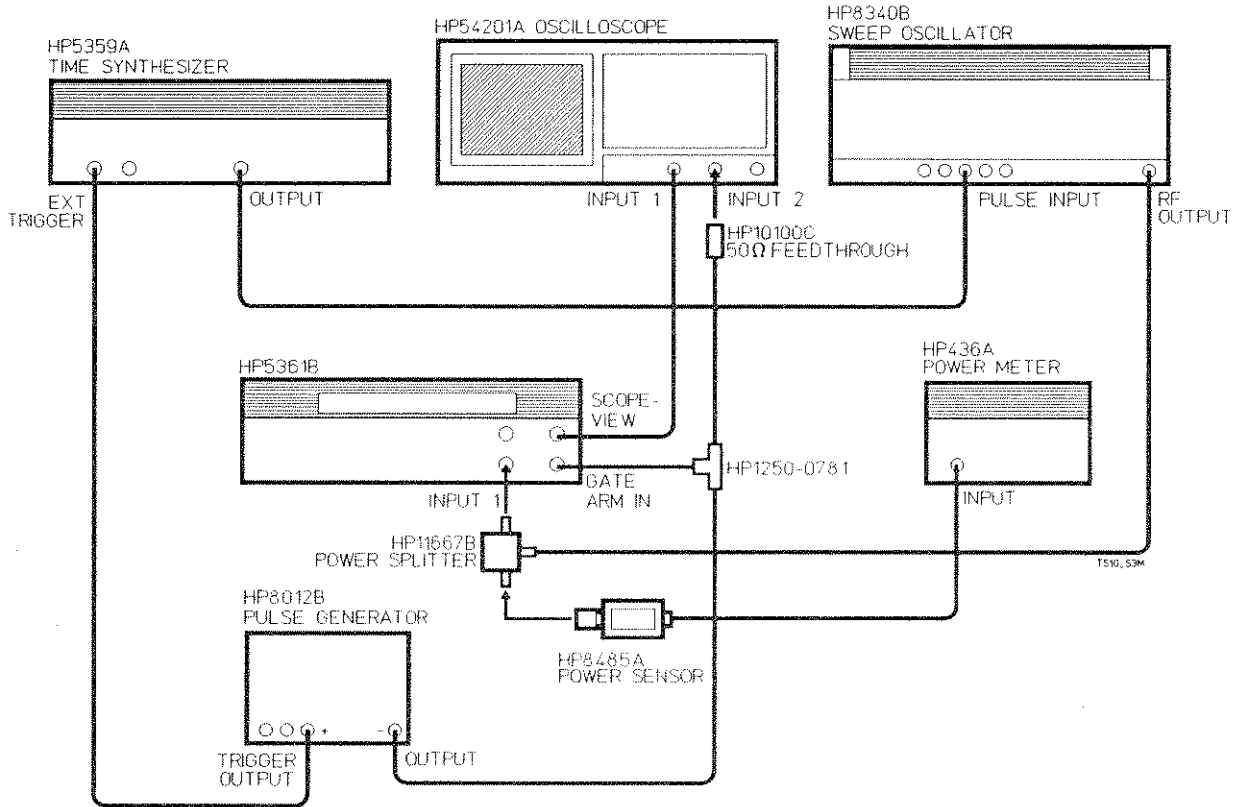

Figure C-8. External Gate Mode Test and External Arm Mode Test

1. Set the HP 5359A for a pulse width of 2 ms, 1 ns delay, with the external trigger level at +2 volts. Set the polarity to norm. and pos.; amplitude to 2.5 volts, and offset to off.
2. Set the following parameters on the 8012B pulse generator:
  - a. PULSE PERIOD . . . . . 10 ms - 1 ms
  - b. PULSE PERIOD VERNIER . . . . . adjust for 20 ms PRI
  - c. PULSE SWITCH . . . . . Normal
  - d. DELAY . . . . . .0.1 ms - 10 ms
  - e. PULSE WIDTH SWITCH . . . . . .0.1 ms - 10 ms
  - f. PULSE WIDTH VERNIER . . . . . adjust for 1 ms (see Figure C-9)
  - g. TRANSITION TIME . . . . . N/A
  - h. LEADING AND TRAILING EDGES . . . . . ccw
  - i. AMPLITUDE SWITCH . . . . . 5V (Max)
  - j. AMPLITUDE VERNIER . . . . . Max

- k. OFFSET SWITCH . . . . . ON
- l. PULSE POLARITY . . . . . Negative
- m. OUTPUT SWITCH . . . . . Normal
- n. INT. LOAD . . . . . In

3. Ensure that the above signal parameters are correct by observing the waveform on an oscilloscope with 50  $\Omega$  termination for final adjustment. The signal should appear as shown in the top waveform of *Figure C-9/A* with a 5 volt amplitude.
4. The most critical setting is the offset vernier. Adjust this control so that the square wave baseline is at 0 V. To move the square wave left or right, adjust the 8012B delay vernier.
5. Set the HP 436A Power Meter for auto range (Range Hold button OUT and dBm Mode).
6. Set the HP 8340B Synthesizer to 10 GHz and output power level for a reading of -20 dBm on the 436A power meter.
7. Power-up the HP 5361B counter, select 1 kHz resolution, and set the gate mode to Internal. If the counter is not energized from the STBY state, allow at least 30 minutes for complete warm-up.
8. Adjust the 8012B pulse delay vernier so the oscilloscope display conforms to the waveform shown in *Figure C-9/B* (When using an analog scope, place the vertical display in chop position and internal trigger in channel B. Channel A - dc coupling, channel B - ac coupling.)
9. Verify the following pulse envelope parameters with the HP 5361B:

PRF = 50 Hz  
 PRI = 20 ms  
 OFFTIME = 18 ms  
 PW = 2 ms

(Make the necessary adjustments to either the 5359A or 8012B to obtain the above values. Pulse width can be adjusted from the 5359A. PRI can be adjusted from the 8012B pulse period Vernier.)

10. Verify that the HP 5361B counts correctly at 10 GHz with Internal gate mode.
11. Set the gate mode to External and verify that the HP 5361B counts correctly at 10 GHz with External gate mode. Review *Figure C-9* carefully and make additional fine tune adjustments to the 8012B offset or delay vernier settings for proper counter operation while in External gate mode.

The External gate mode should be used to measure the RF frequency only, and not the pulse envelope parameters.

12. Record the results on the Performance Test Record.

**NOTE**

The count accuracy of the HP 5361B is shown in Graphs 2 and 3, Resolution and Gate Error, of the Appendix A Specifications for a 2 ms Pulse when the counter is phase-locked to a house standard.

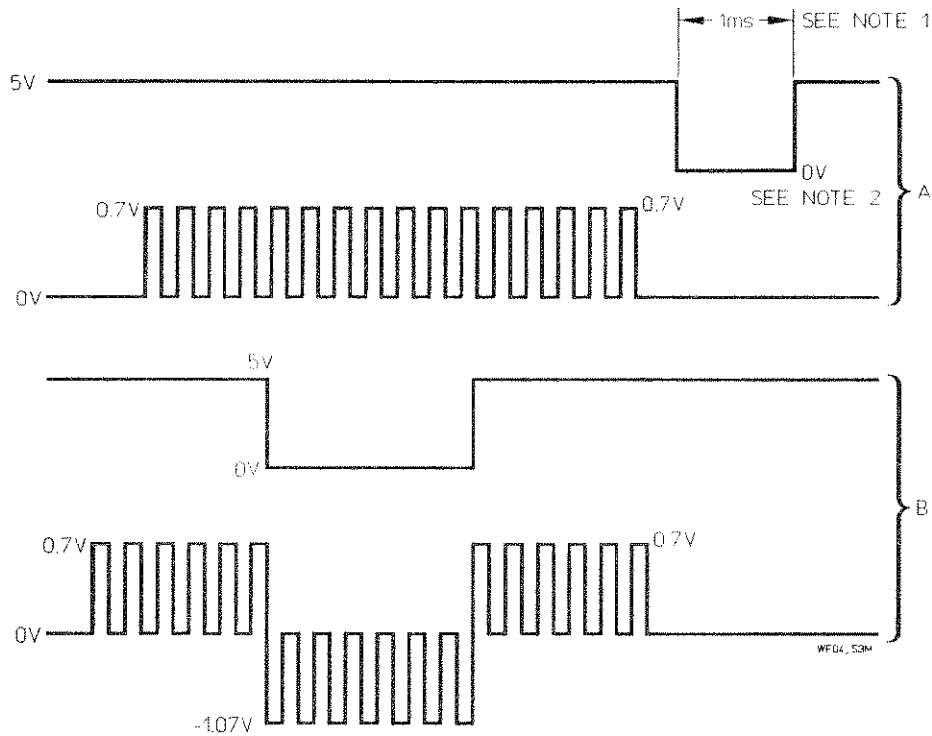

NOTES

1. ADJUST 8012B WIDTH VERNIER FOR PULSE WIDTH OF 1ms.
2. ADJUST 8012B OFFSET VERNIER TO ENSURE THAT THE SQUARE WAVE BASELINE IS AT 0 VOLTS
3. ALL VOLTAGES ARE NOMINAL

Figure C-9. External Gate Mode Test Waveforms

## HP 9000 Program Listing

```

10      !HP5361A/B MICROWAVE FREQUENCY PULSE COUNTER
20      !THIS PROGRAM IS DESIGNED TO WORK ON A SERIES 200 COMPUTER. TO CONVERT
30      !IT FOR ANOTHER COMPUTER, MAKE SURE THE MASK BIT IS PROPERLY SET IN CHECK PO40 !INT 14.
40      !
50      !THIS VERSION ALSO ALLOWS USERS TO CHANGE THE HP-IB ADDRESS OF THE PRINTER
60      ! HP-IB OPERATIONAL VERIFICATION PROGRAM
70      ! AJ
80      ! DATE: 890525
90      ! REVISION A
100     ! This program exercises the 5361A/B through the majority of its command
110     ! code set via HP-IB. The program consists of 17 checkpoints, and
120     ! provides the user with the ability to execute and repeat these tests
130     ! in any order. Also provided are options to print the checkpoint
140     ! summary and results. The program relies on subroutines in addition
150     ! to arrays and simple variables.
160     !
170     OPTION BASE 1
180     DIM Ascii_data$(24),Horiz_line$(80),Inst_id$(7)
190     DIM Setup$(76),Title$(80)
200     DIM Fail_address(30),Pass_address(30),Test_results$(20){13}
210     INTEGER Test_number
220     Initialize:
230     ON ERROR GOTO Error_exit
240     PRINTER IS CRT
250     CONTROL KBD,1;0
260     CONTROL KBD,2;2
270     OUTPUT KBD;CHR$(255)&"K";           ! Clear screen + home cursor
280     GRAPHICS OFF
290     ALPHA ON
300     CONTROL 1,12;1           ! Key labels off
310     RESET 7
320     Test_number=0
330     Checkpoint=0
340     Ascii_data$=""
350     Inst_id$=""
360     Horiz_line$="*****"
370     !Initialize test results array to "NOT PERFORMED"
380     FOR I=1 TO 17
390     Test_results$(I)="NOT PERFORMED"
400     NEXT I
410     PRINT " "
420     Title$="HP 5361A/B HP-IB OPERATIONAL VERIFICATION PROGRAM"
430     GOSUB Sub_title
440     PRINT Horiz_line$
450     PRINT "The HP-IB address of the printer is assumed to be 701. Would"
460     PRINT "you like to change that?"
470     PRINT
480     PRINT "CAUTION! Do not set printer address the same as the counter's address."
490     GOSUB Clear_keys
500     ON KEY 1 LABEL "YES" GOTO Change_add
510     ON KEY 6 LABEL " " GOTO Change_add
520     ON KEY 4 LABEL " NO" GOTO Same_add
530     ON KEY 9 LABEL " " GOTO Same_add
540     GOSUB wait_for_key
550     Same_add:           ! ASSUME PRINTER ADDRESS TO BE 701
560     Ptr_add=701
570     GOTO Start_program
580     Change_add:       ! CHANGE THE ADDRESS OF THE PRINTER FROM 701
590     CONTROL 1,12;1
600     INPUT "PLEASE ENTER THE CORRECT ADDRESS OF THE PRINTER.",Ptr_add

```

```

610  IF (Ptr_add<(700) OR Ptr_add>(731) OR Ptr_add=(721)) THEN GOTO Bad_add
620  Start_program:|
630  OUTPUT KBD;CHR$(255)&"K";
640  Title$="HP 5361A/B HP-IB OPERATIONAL VERIFICATION PROGRAM"
650  GOSUB Sub_title
660  PRINT Horiz_line$
670  PRINT
680  GOSUB Menu
690  IF VAL(SYSTEM$( "PRINTER IS" ))=Ptr_add THEN GOTO Already_printed  | ***** 701
700  PRINT
710  PRINT "Would you like a hardcopy of the checkpoint summary?"
720  PRINT
730  PRINT "YES - Press K1 to receive a hardcopy, or"
740  PRINT "NO - Press K4 to continue."
750  GOSUB Clear_keys
760  ON KEY 1 LABEL "YES" GOTO Printer_setup
770  ON KEY 6 LABEL " " GOTO Printer_setup
780  ON KEY 4 LABEL "NO" GOTO Already_printed
790  ON KEY 9 LABEL " " GOTO Already_printed
800  GOSUB Wait_for_key
810  Printer_setup:                                     | Yes, printout
820  GOSUB Keys_off
830  OUTPUT KBD;CHR$(255)&"K";
840  PRINTER IS Ptr_add
850  ON ERROR GOTO Bad_add
860  ON TIMEOUT Ptr_add DIV 100,1 GOTO Prnt_broke
870  OUTPUT Ptr_add USING "#,K";" "                   | TEST FOR A RESPONSE
880  OFF TIMEOUT
890  OFF ERROR
900  GOSUB Menu
910  GOTO Already_printed
920  Bad_add:                                          |
930  DISP Ptr_add;" IS INVALID. TRY AGAIN."
940  BEEP 600,.3
950  WAIT 2
960  OFF ERROR
970  OFF TIMEOUT
980  GOTO Change_add
990  Prnt_broke:                                     |
1000 CONTROL 1,12;1 !key labels off
1010 DISP (Ptr_add);"NOT RESPONDING. CHECK PRINTER IS ON, & ADDRESS & HOOKUP IS CORRECT."
1020 BEEP 600,.3
1030 WAIT 3
1040 GOTO Initialize
1050 PRINTER IS CRT
1060 Already_printed:                                |
1070 GOSUB Keys_off
1080 PRINTER IS CRT
1090 OUTPUT KBD;CHR$(255)&"K";
1100 Title$="MAKE THE CONNECTIONS"
1110 GOSUB Sub_title
1120 PRINT Horiz_line$
1130 PRINT
1140 PRINT "Connect the HP-IB Interface to the rear panel of the counter and turn on the"
1150 PRINT "power. A source capable of outputting 1GHz from -10 to +20 dBm will also be"
1160 PRINT "needed later to complete this verification. For pulse testing, set-up the"
1170 PRINT "test equipment as outlined in the manual."
1180 PRINT
1190 PRINT "Consult the counter Operating and Service manual for additional information."
1200 GOSUB Ready_start
1210 |
1220 GOSUB Begin_search

```

```

1230 GOTO First_check
1240 !*****
1250 !           START OF CHECKPOINT TESTS
1260 !*****
1270 !
1280 Chk1:           !
1290 Test_number=1
1300 Title$="REMOTE', 'LOCAL LOCKOUT', AND 'LOCAL'"
1310 GOSUB Print_title
1320 PRINT "Checkpoint 1 tests the REMOTE, LOCAL LOCKOUT, and LOCAL HP-IB commands."
1330 PRINT "Each command will be programmed and the operator will be prompted as to"
1340 PRINT "what conditions should be verified."
1350 PRINT
1360 GOSUB Ready_start
1370 !
1380 LOCAL Address
1390 REMOTE Address
1400 OUTPUT Address;"INIT"
1410 PRINT
1420 Title$="REMOTE"
1430 GOSUB Sub_title
1440 PRINT
1450 PRINT "Verify that the INT, REM, LSN, FM NORM, and AUTO annunciators are on."
1460 PRINT
1470 GOSUB Ready_start
1480 PRINT
1490 Title$="LOCAL LOCKOUT"
1500 GOSUB Sub_title
1510 PRINT
1520 PRINT "Verify that pressing any of the front panel keys other than POWER will"
1530 PRINT "not affect the ";Inst_id$;". "
1540 PRINT
1550 LOCAL LOCKOUT 7
1560 GOSUB Ready_start
1570 PRINT
1580 Title$="LOCAL"
1590 GOSUB Sub_title
1600 PRINT
1610 PRINT "Verify that the REM annunciator is no longer on, and the ";Inst_id$
1620 PRINT "responds to front panel entries."
1630 LOCAL 7
1640 PRINT
1650 GOSUB Ready_start
1660 REMOTE Address
1670 GOTO Record_results
1680 ! End of Chk1
1690 !
1700 Chk2:           !
1710 Test_number=2
1720 Title$="SELF CHECK ('TEST?')"
1730 GOSUB Print_title
1740 PRINT "Checkpoint 2 tests the 'TEST?' HP-IB command. The results of the SELF CHECK"
1750 PRINT "will be sent over the bus and displayed on the controller CRT."
1760 PRINT
1770 GOSUB Ready_start
1780 REMOTE Address
1790 OUTPUT Address;"INIT"
1800 OUTPUT Address;"TEST?"
1810 ENTER Address;Ascii_data$
1820 PRINT "The results of SELF CHECK are: ";TRIM$(Ascii_data$)
1830 PRINT
1840 IF Ascii_data${1,4}="PASS" THEN GOTO Pass_test1

```

```

1850 PRINT "The ";Inst_id$;" failed the SELF CHECK. It is recommended that the fault on"
1860 PRINT "the ";TRIM$(Ascii_data${18,19});" or associated assemblies be corrected"
1870 PRINT "before continuing with the HP-IB verification."
1880 PRINT
1890 Pass_test1:                                !
1900 GOTO Record_results
1910 ! End of Chk2
1920 !
1930 Chk3:!
1940 Test_number=3
1950 Title$=" 'DISPLAY' "
1960 GOSUB Print_title
1970 PRINT "Checkpoint 3 tests the 'DISPLAY' HP-IB command."
1980 PRINT
1990 GOSUB Ready_start
2000 OUTPUT Address;"INIT"
2010 OUTPUT Address;"DISPLAY, 'HP-IBVERIFICATION' "
2020 PRINT "Verify that the ";Inst_id$;" display shows 'HP-IB VERIFICATION' ."
2030 PRINT
2040 GOSUB Ready_start
2050 OUTPUT Address;"DISPLAY, '' "
2060 GOTO Record_results
2070 ! End of Chk3
2080 !
2090 Chk4:!
2100 Test_number=4
2110 Title$=" 'INIT' and 'RESET' "
2120 GOSUB Print_title
2130 PRINT "Checkpoint 4 tests the 'INIT' and 'RESET' HP-IB commands ."
2140 PRINT
2150 GOSUB Ready_start
2160 OUTPUT Address;"INIT"
2170 ! SET UP INSTRUMENT STATE TO BE INITIALIZED
2180 OUTPUT Address;"OFFSET,ON;SCALE,ON;SMOOTH,ON"
2190 REMOTE Address
2200 OUTPUT Address;"INIT"
2210 Title$=" 'INIT' "
2220 GOSUB Sub_title
2230 PRINT
2240 PRINT "Verify that the INT, REM, LSN, FM NORM and AUTO annunciators are"
2250 PRINT "on that the display shows: 00 000 000 000 CW without an input."
2260 PRINT
2270 GOSUB Ready_start
2280 !SET UP ERROR CONDITION - MANUAL FREQ 9E+99 IS OUT OF RANGE
2290 OUTPUT Address;"MANUAL,9E+99"
2300 Title$=" 'RESET' "
2310 GOSUB Sub_title
2320 PRINT
2330 PRINT "Verify that the ";Inst_id${1,7};" shows: OUT OF RANGE 3 ERROR ."
2340 PRINT
2350 PRINT "Press ENTER to send the 'RESET' command. Verify that the error message is"
2360 PRINT "cleared and the INT, REM, LSN, FM NORM and AUTO annunciators are on."
2370 GOSUB Ready_start
2380 OUTPUT Address;"RESET"
2390 PRINT
2400 GOTO Record_results
2410 ! End of Chk4
2420 !
2430 Chk5:!
2440 Test_number=5
2450 Title$=" 'OVEN?' and 'REF?' "
2460 GOSUB Print_title

```

```
2470 PRINT "Checkpoint 5 tests the 'OVEN?' and 'REF?' HP-IB commands."
2480 PRINT
2490 GOSUB Ready_start
2500 Title$=" 'REF?'"
2510 GOSUB Sub_title
2520 PRINT
2530 PRINT "Disconnect the external reference if one is connected."
2540 PRINT
2550 GOSUB Ready_start
2560 REMOTE Address
2570 OUTPUT Address;"INIT"
2580 OUTPUT Address;"REF?"
2590 ENTER Address;Ascii_data$ ! Enter the status of the reference
2600 PRINT
2610 PRINT "Verify that the EXT REF annunciator is off."
2620 PRINT
2630 GOSUB Ready_start
2640 PRINT
2650 PRINT "The ";Inst_id$;" has returned its timebase reference status as ";
2660 PRINT TRIM$(Ascii_data$);"ERNAL."
2670 PRINT
2680 IF Ascii_data$="INT" THEN GOTO Okay1
2690 PRINT "RETURNED HP-IB DATA INCORRECT";CHR$(7)
2700 PRINT
2710 Okay1:
2720 GOSUB Ready_start
2730 Title$=" 'REF?'"
2740 GOSUB Sub_title
2750 PRINT
2760 PRINT "Connect an external timebase to the external reference on the rear panel."
2770 PRINT
2780 GOSUB Ready_start
2790 OUTPUT Address;"REF?"
2800 ENTER Address;Ascii_data$
2810 PRINT
2820 PRINT "Verify that the EXT REF annunciator is on. The ";Inst_id$;" has returned"
2830 PRINT "a reference status of ";TRIM$(Ascii_data$);"ERNAL."
2840 PRINT
2850 IF TRIM$(Ascii_data$)="EXT" THEN GOTO Okay2
2860 PRINT "RETURNED HP-IB DATA INCORRECT"
2870 Okay2:
2880 GOSUB Ready_start
2890 OUTPUT KBD;CHR$(255)&"K";
2900 Title$=" 'OVEN?'"
2910 GOSUB Sub_title
2920 PRINT
2930 PRINT "Disconnect the external timebase. If the ";Inst_id$;" has Option 001 or"
2940 PRINT "010 (ovenized oscillators), the returned status is meaningful. If the"
2950 PRINT "counter does not have these options, the returned status will always"
2960 PRINT "be 'WARM'."
2970 PRINT
2980 GOSUB Ready_start
2990 OUTPUT Address;"OVEN?"
3000 ENTER Address;Ascii_data$
3010 PRINT
3020 PRINT "The oven status is ";Ascii_data$;". "
3030 PRINT
3040 GOTO Record_results
3050 ! End of Chk5
3060 !
3070 Chk6:
3080 Test_number=6
```



```

3090 Title$="'ERR?'"
3100 GOSUB Print_title
3110 OUTPUT Address;"INIT"
3120 PRINT "Checkpoint 6 tests the 'ERR?' HP-IB command. An error state will be"
3130 PRINT "programmed and the type of error will read back to the controller."
3140 PRINT
3150 GOSUB Ready_start
3160 OUTPUT Address;"MANUAL,9E99" ! Out of range, error guaranteed
3170 OUTPUT Address;"ERR?"
3180 ENTER Address;Ascii_data$
3190 PRINT "Verify that the ";Inst_id$;" displays OUT OF RANGE 3 ERROR."
3200 PRINT
3210 IF Ascii_data$[18,18]="3" THEN GOTO Okay3
3220 PRINT "RETURNED HP-IB DATA INCORRECT."
3230 PRINT
3240 Okay3:|
3250 PRINT "Press ENTER to RESET the ";Inst_id$;"."
3260 GOSUB Ready_start
3270 OUTPUT Address;"RESET"
3280 GOTO Record_results
3290 ! End of Chk6
3300 !
3310 Chk7:|
3320 Test_number=7
3330 Title$="'SET' and 'SET?'"
3340 GOSUB Print_title
3350 PRINT "Checkpoint 7 tests the 'SET' and 'SET?' HP-IB commands. A configuration"
3360 PRINT "will be programmed and then saved using the 'SET?' command. The ";
3370 PRINT Inst_id$
3380 PRINT "will be set to the initial power-on condition and then reprogrammed"
3390 PRINT "using the 'SET' command."
3400 PRINT
3410 GOSUB Ready_start
3420 REMOTE Address
3430 OUTPUT Address;"INIT"
3440 OUTPUT Address;"SMOOTH,ON;SCALE,1,ON;FMRATE,LOW" ! Test setup
3450 PRINT "The front panel set-up to be stored has the SCALE, SMOOTH, INT, REM, LSN,"
3460 PRINT "FM LOW, and AUTO annunciators on."
3470 PRINT
3480 PRINT "Verify these annunciators."
3490 GOSUB Ready_start
3500 OUTPUT Address;"SET?"
3510 ! STORE THE SET-UP IN SETUP$
3520 ENTER Address;Setup$
3530 OUTPUT Address;"INIT"
3540 PRINT
3550 PRINT
3560 PRINT "This configuration is now stored and the ";Inst_id$;" is initialized."
3570 PRINT
3580 PRINT
3590 PRINT "Verify that the INT, REM, LSN, FM NORM, and AUTO annunciators are on."
3600 PRINT
3610 GOSUB Ready_start
3620 OUTPUT Address;"SET,'"";Setup$;"'"
3630 PRINT "Verify that the SCALE, SMOOTH, INT, REM, LSN, FM LOW, and AUTO annunciators"
3640 PRINT "are on again."
3650 PRINT
3660 GOSUB Ready_start
3670 GOTO Record_results
3680 ! End of Chk7
3690 !
3700 Chk8:|

```

```
3710 Test_number=8
3720 Title$="'LOWZ' and 'HIGHZ'"
3730 GOSUB Print_title
3740 PRINT "Checkpoint 8 tests the 'LOWZ' and 'HIGHZ' HP-IB commands. Connect the"
3750 PRINT "rear panel 10 MHz OUT to Input 2 of the ";Inst_id$;"."
3760 PRINT
3770 GOSUB Ready_start
3780 REMOTE Address
3790 OUTPUT Address;"INIT"
3800 OUTPUT Address;"LOWZ"
3810 ENTER Address;Meas_data
3820 OUTPUT KBD;CHR$(255)&"K";
3830 Title$="'LOWZ'"
3840 GOSUB Sub_title
3850 PRINT
3860 PRINT "Verify that the 50 ohm annunciator is on as well as the INT, REM and TLK"
3870 PRINT "annunciators. The OPEN annunciator should be flashing. The display should"
3880 PRINT "read: 10 000 000 CW IN2"
3890 PRINT
3900 IF Meas_data=10000000 THEN GOTO Okay4
3910 PRINT "RETURNED HP-IB DATA INCORRECT: ";Meas_data
3920 Okay4:!
3930 PRINT
3940 GOSUB Ready_start
3950 OUTPUT Address;"HIGHZ"
3960 ENTER Address;Meas_data
3970 OUTPUT KBD;CHR$(255)&"K";
3980 Title$="'HIGHZ'"
3990 GOSUB Sub_title
4000 PRINT
4010 PRINT "Verify that the INT, REM, TLK, and 1 Mohm annunciators are on. The OPEN"
4020 PRINT "annunciator should be flashing. The display should read: 10 000 000 CW IN2"
4030 PRINT
4040 IF Meas_data=10000000 THEN GOTO Okay5
4050 PRINT "RETURNED HP-IB DATA INCORRECT: ";Meas_data
4060 PRINT
4070 Okay5:!
4080 GOTO Record_results
4090 ! End of Chk8
4100 !
4110 Chk9:!
4120 Test_number=9
4130 Title$="'SAMPLE and TRIGGER'"
4140 GOSUB Print_title
4150 PRINT "Checkpoint 9 tests the 'SAMPLE' and 'TRIGGER' HP-IB commands. Connect the"
4160 PRINT "rear panel 10 MHz OUT to Input 2 of the ";Inst_id$;"."
4170 PRINT
4180 GOSUB Ready_start
4190 OUTPUT Address;"INIT"
4200 OUTPUT Address;"SAMPLE,HOLD;HIGHZ"
4210 PRINT "Verify that the INT, HOLD, REM, LSN, and 1Mohm annunciators are on. The display"
4220 PRINT "should read: HOLDING- -"
4230 PRINT
4240 INPUT "Press ENTER to trigger the counter and take a measurement.",Dummy$
4250 OUTPUT Address;"TRIGGER"
4260 ENTER Address;Meas_data
4270 OUTPUT KBD;CHR$(255)&"K";
4280 PRINT "The measurement should be: 10 000 000 CW IN2"
4290 PRINT
4300 IF Meas_data=10000000 THEN GOTO Okay6
4310 PRINT "RETURNED HP-IB DATA INCORRECT: ";Meas_data
4320 PRINT
```

```

4330 Okay6:1
4340 GOTO Record_results
4350 ! End of Chk9
4360 !
4370 Chk10:1
4380 Test_number=10
4390 Title$='RESOL' and 'HIRESOL'
4400 GOSUB Print_title
4410 PRINT "Checkpoint 10 tests the 'RESOL' and 'HIRESOL' HP-IB commands. Connect the"
4420 PRINT "rear panel 10 MHz OUT to Input 2 of the ";Inst_id$;". "
4430 PRINT
4440 GOSUB Ready_start
4450 OUTPUT Address;"INIT"
4460 OUTPUT Address;"HIGHZ;RESOL,6" ! 1 MHz resolution
4470 Title$="RESOL"
4480 GOSUB Sub_title
4490 PRINT
4500 PRINT "Verify that the current reading is to 1MHz resolution. Press ENTER"
4510 PRINT " to program another decade of resolution."
4520 PRINT
4530 PRINT "Continue pressing ENTER until the counter displays the measurement with"
4540 PRINT "1Hz resolution."
4550 PRINT
4560 FOR I=5 TO 0 STEP -1
4570 DISP "Press ENTER to decrease the resolution to ";
4580 DISP INT(10^(I));"Hz."
4590 INPUT "",Dummy$
4600 OUTPUT Address;"RESOL,";I
4610 DISP
4620 NEXT I
4630 OUTPUT KBD;CHR$(255)&"K";
4640 OUTPUT Address;"HIRESOL,ON"
4650 PRINT "Verify that the INT, REM, LSN, 1Mohm, and HIGH RESOL INDICATORS (**) are on,"
4660 PRINT "the OPEN annunciator is flashing, and the display reads: 10 000 000. 0** IN2"
4670 PRINT
4680 GOTO Record_results
4690 ! End of Chk10
4700 !
4710 Chk11:1
4720 Test_number=11
4730 Title$="OFFSET', 'SCALE', and 'SMOOTH'"
4740 GOSUB Print_title
4750 PRINT "Checkpoint 11 tests the 'OFFSET', 'SCALE', and 'SMOOTH' HP-IB commands."
4760 PRINT "Connect the rear panel 10 MHz OUT to Input 2 of the ";Inst_id$;". "
4770 PRINT
4780 GOSUB Ready_start
4790 REMOTE Address
4800 OUTPUT Address;"INIT"
4810 OUTPUT Address;"HIGHZ;OFFSET,-5E6,ON" ! Should be 5MHz
4820 Title$="OFFSET"
4830 GOSUB Sub_title
4840 PRINT
4850 PRINT "Verify that the OFFSET, INT, REM, TLK, and 1Mohm annunciators are on. The"
4860 PRINT "OPEN light should be flashing. The display should read: 5 000 000 CW IN2"
4870 ENTER Address;Meas_data
4880 IF Meas_data=5000000 THEN GOTO Okay7
4890 PRINT
4900 PRINT "RETURNED HP-IB DATA IS INCORRECT: ";Meas_data
4910 Okay7:1
4920 PRINT
4930 GOSUB Ready_start
4940 OUTPUT Address;"OFFSET,OFF;SCALE,2,ON" ! Should be 20MHz

```

```
4950 Title$="SCALE"
4960 GOSUB Sub_title
4970 PRINT
4980 PRINT "Verify that the SCALE, INT, REM, TLK, and 1Mohm annunciators are on. The"
4990 PRINT "OPEN light should be flashing. The display should read: 20 000 000 CW IN2"
5000 ENTER Address;Meas_data
5010 IF Meas_data=20000000 THEN GOTO Okay8
5020 PRINT
5030 PRINT "RETURNED HP-IB DATA INCORRECT: ";Meas_data
5040 Okay8:|
5050 PRINT
5060 GOSUB Ready_start
5070 OUTPUT KBD;CHR$(255)&"K";
5080 Title$="SMOOTH"
5090 GOSUB Sub_title
5100 PRINT
5110 PRINT "After pressing ENTER to program the counter, verify that the SMOOTH, INT, REM,"
5120 PRINT "LSN, and 1Mohm annunciators are on. The OPEN annunciator should be flashing."
5130 PRINT "The display should initially show 10 000 and increase the resolution to"
5140 PRINT "1Hz."
5150 PRINT
5160 GOSUB Ready_start
5170 OUTPUT Address;"SMOOTH,ON;HIGHZ;SCALE,OFF"
5180 GOSUB Ready_start
5190 OUTPUT Address;"SMOOTH,OFF"
5200 GOTO Record_results
5210 | End of Chk11
5220 |
5230 Chk12:|
5240 Test_number=12
5250 Title$="AUTO' and 'MANUAL'"
5260 GOSUB Print_title
5270 PRINT "Checkpoint 12 tests the 'AUTO' and 'MANUAL' HP-IB commands. Input a 1GHz"
5280 PRINT "signal at -5 dBm to Input 1 of the ";Inst_id$;"."
5290 PRINT
5300 GOSUB Ready_start
5310 REMOTE Address
5320 OUTPUT Address;"INIT"
5330 OUTPUT Address;"SAMPLE,HOLD;TRIGGER" | Auto mode, single measurement
5340 ENTER Address;Meas_data
5350 IF Meas_data=1.E+38 THEN GOTO Fail
5360 OUTPUT KBD;CHR$(255)&"K";
5370 Title$="AUTO'"
5380 GOSUB Sub_title
5390 PRINT
5400 PRINT "Verify that the INT, HOLD, REM, TLK, FM NORM, and AUTO annunciators are on"
5410 PRINT "and the ";Inst_id$;" is displaying ";Meas_data;" Hz."
5420 PRINT
5430 PRINT "If the ";Inst_id$;" display does not match the above reading, then an"
5440 PRINT "error occurred in the HP-IB transfer."
5450 PRINT
5460 GOSUB Ready_start
5470 OUTPUT KBD;CHR$(255)&"K";
5480 Title$="MANUAL'"
5490 GOSUB Sub_title
5500 PRINT
5510 PRINT "This will trigger the ";Inst_id$;"."
5520 GOSUB Ready_start
5530 OUTPUT Address;"MANUAL,LAST"
5540 OUTPUT Address;"SAMPLE,HOLD;TRIGGER"
5550 ENTER Address;Meas_data
5560 IF Meas_data=1.E+38 THEN GOTO Fail
```

```
5570 OUTPUT KBD;CHR$(255)&"K";
5580 Title$=" 'MANUAL' "
5590 GOSUB Sub_title
5600 PRINT
5610 PRINT "Verify that the INT, HOLD, REM, TLK, and MAN annunciators are on"
5620 PRINT "and the ";Inst_id$;" is displaying ";Meas_data;" Hz."
5630 PRINT
5640 PRINT "If the ";Inst_id$;" display does not match the above reading, then an"
5650 PRINT "error occurred in the HP-IB transfer."
5660 PRINT
5670 GOTO Record_results
5680 Fail:|
5690 PRINT
5700 PRINT Inst_id$;" failed to acquire a"
5710 PRINT "signal."
5720 PRINT
5730 GOSUB Ready_start
5740 PRINT
5750 GOTO Record_results
5760 ! End of Chk12
5770 !
5780 Chk13:|
5790 Test_number=13
5800 Title$=" 'FMRATE' "
5810 GOSUB Print_title
5820 REMOTE Address
5830 OUTPUT Address;"INIT"
5840 PRINT "Checkpoint 13 tests the 'FMRATE' HP-IB command."
5850 PRINT
5860 PRINT "Input a 1 GHz signal at -5 dBm to Input 1 of the ";Inst_id$;". "
5870 PRINT
5880 GOSUB Ready_start
5890 OUTPUT Address;"AUTO;FMRATE,NORMAL"
5900 OUTPUT KBD;CHR$(255)&"K";
5910 Title$=" 'FMRATE', NORMAL "
5920 GOSUB Sub_title
5930 PRINT
5940 PRINT "Verify that the INT, REM, LSN, FM NORM, and AUTO annunciators are on. The OPEN"
5950 PRINT "annunciator should be flashing."
5960 PRINT
5970 GOSUB Ready_start
5980 OUTPUT Address;"FMRATE,LOW"
5990 OUTPUT KBD;CHR$(255)&"K";
6000 Title$=" 'FMRATE', LOW "
6010 GOSUB Sub_title
6020 PRINT
6030 PRINT "Verify that the INT, REM, LSN, FM LOW, and AUTO annunciators are on. The OPEN"
6040 PRINT "annunciator should be flashing."
6050 PRINT
6060 GOTO Record_results
6070 ! End of Chk13
6080 !
6090 Chk14:|
6100 Test_number=14
6110 Title$=" 'SRQMASK' "
6120 GOSUB Print_title
6130 OUTPUT Address;"INIT"
6140 REMOTE Address
6150 PRINT "Checkpoint 14 tests the 'SRQMASK' HP-IB command."
6160 PRINT
6170 PRINT "Set the signal source to output a 1 GHz signal at a level of 0 dBm"
6180 GOSUB Ready_start
```

```
6190  OUTPUT KBD;CHR$(255)&"K";
6200  Title$="MEASUREMENT COMPLETE bit"
6210  GOSUB Sub_title
6220  PRINT
6230  PRINT "This section tests the MEASUREMENT COMPLETE bit of the status byte of"
6240  PRINT "the ";Inst_id$;"."
6250  PRINT
6260  OUTPUT Address;"INIT"
6270  OUTPUT Address;"SAMPLE,HOLD;SRQMASK,2"
6280  GOSUB Ready_start
6290  ON INTR 7 GOTO Meas_intr
6300  ENABLE INTR 7;2
6310  OUTPUT Address;"TRIGGER"
6320  WAIT 2
6330  OFF INTR 7
6340  Fail_measure:|
6350  PRINT Inst_id$;" FAILED the MEASUREMENT COMPLETE bit test."
6360  GOTO Meas_done
6370  Meas_intr:|
6380  OFF INTR 7
6390  STATUS 7,1;B
6400  S=SPOLL(Address)
6410  PRINT "THE SPOLL IS ";S
6420  IF BIT(S,1) THEN GOTO Pass_measure
6430  GOTO Fail_measure
6440  Pass_measure:|
6450  PRINT Inst_id$;" PASSED the MEASUREMENT COMPLETE bit test."
6460  Meas_done:|
6470  PRINT
6480  GOSUB Ready_start
6490  OUTPUT KBD;CHR$(255)&"K";
6500  Title$="LOCAL bit"
6510  GOSUB Sub_title
6520  PRINT
6530  PRINT "This section tests the LOCAL bit of the status bytes of the ";Inst_id$;"."
6540  PRINT
6550  OUTPUT Address;"SRQMASK,16"
6560  GOSUB Ready_start
6570  ON INTR 7 GOTO Srq_intr
6580  ENABLE INTR 7;2
6590  LOCAL Address! SHOULD SET LCL BIT
6600  WAIT 1
6610  OFF INTR 7
6620  Fail_local:|
6630  PRINT Inst_id$;" FAILED the LOCAL bit test."
6640  GOTO Done_srq
6650  Srq_intr:|
6660  OFF INTR 7
6670  STATUS 7,1;B
6680  S=SPOLL(Address)
6690  PRINT "THE SPOLL IS ";S
6700  IF BIT(S,4) THEN GOTO Pass_local
6710  GOTO Fail_local
6720  Pass_local:|
6730  PRINT Inst_id$;" PASSED the LOCAL bit test."
6740  Done_srq:|
6750  PRINT
6760  GOSUB Ready_start
6770  OUTPUT KBD;CHR$(255)&"K";
6780  Title$="ERROR bit"
6790  GOSUB Sub_title
6800  PRINT
```

```

6810 PRINT "This section tests the ERROR bit of the status byte of the ";Inst_id$;". "
6820 PRINT
6830 OUTPUT Address;"SRQMASK,4"
6840 GOSUB Ready_start
6850 ON INTR 7 GOTO Error_intr
6860 ENABLE INTR 7;2
6870 OUTPUT Address;"MANUAL,9E+99" ! Error condition
6880 WAIT 1
6890 OFF INTR 7
6900 Fail_error:!
6910 PRINT Inst_id$;" FAILED the ERROR bit test."
6920 GOTO Done_error
6930 Error_intr:!
6940 OFF INTR 7
6950 STATUS 7,1;B
6960 S=SPOLL(Address)
6970 PRINT "THE SPOLL IS ";S
6980 IF BIT(S,2) THEN GOTO Pass_error
6990 GOTO Fail_error
7000 Pass_error:!
7010 PRINT Inst_id$;" PASSED the ERROR bit test."
7020 Done_error:!
7030 OUTPUT Address;"RESET"
7040 PRINT
7050 GOSUB Ready_start
7060 OUTPUT KBD;CHR$(255)&"K";
7070 Title$="OUTPUT DATA READY bit"
7080 GOSUB Sub_title
7090 PRINT
7100 PRINT "This section tests the OUTPUT DATA READY bit of the status byte of the"
7110 PRINT Inst_id$;". "
7120 PRINT
7130 OUTPUT Address;"SRQMASK,1"
7140 GOSUB Ready_start
7150 ON INTR 7 GOTO Ready_intr
7160 ENABLE INTR 7;2
7170 OUTPUT Address;"ID?"
7180 WAIT 1
7190 OFF INTR 7
7200 Fail_ready:!
7210 PRINT Inst_id$;" FAILED the OUTPUT DATA READY bit test."
7220 GOTO Done_ready
7230 Ready_intr:!
7240 PRINT
7250 OFF INTR 7
7260 STATUS 7,1;B
7270 S=SPOLL(Address)
7280 PRINT "THE SPOLL IS ";S
7290 ENTER Address;Setup$
7300 IF BIT(S,0) THEN GOTO Pass_ready
7310 GOTO Fail_ready
7320 Pass_ready:!
7330 PRINT Inst_id$;" PASSED the OUTPUT DATA READY bit test."
7340 Done_ready:!
7350 PRINT
7360 !OUTPUT Address;"SRQMASK,4"
7370 GOTO Record_results
7380 ! End of Chk14
7390 !
7400 Chk15:!
7410 Test_number=15
7420 Title$=" 'DUMP'"

```

```
7430 GOSUB Print_title
7440 REMOTE Address
7450 OUTPUT Address;"INIT"
7460 PRINT "Checkpoint 15 tests the 'DUMP' HP-IB command."
7470 PRINT
7480 Hookup:|
7490 PRINT "Connect a 1 GHz signal at -5 dBm to Input 1 of the ";Inst_id$;"."
7500 PRINT
7510 PRINT "Press ENTER to begin DUMPING data from the ";Inst_id$;" to the controller."
7520 PRINT "Ten measurements will be taken and displayed."
7530 PRINT
7540 GOSUB Ready_start
7550 REMOTE Address
7560 ENTER Address;Meas_data
7570 IF Meas_data=1.E+38 THEN GOTO Hookup
7580 OUTPUT Address;"MANUAL,LASTF;RESOL,4;DUMP,ON"
7590 PRINT "MEAS# DATA"
7600 FOR I=1 TO 10
7610 ENTER Address;Ascii_data
7620 WAIT .300
7630 PRINT I,Ascii_data,"*10      KHz"
7640 NEXT I
7650 PRINT
7660 OUTPUT Address;"DUMP,OFF"
7670 GOTO Record_results
7680 | End of Chk15
7690 |
7700 Chk16: |
7710 Test_number=16
7720 Title$="PULSE MEASUREMENT"
7730 GOSUB Print_title
7740 PRINT "BEFORE TESTING CHK 16, BE SURE TO MAKE ALL SET-UP AND CONNECTIONS AS
OUTLINED IN THE MANUAL."
7750 OUTPUT Address;"FREQ"
7760 REMOTE Address
7770 PRINT
7780 PRINT
7790 PRINT "CHECKPOINT 16 TESTS THE 'PULSE FREQUENCY' HP-IB COMMAND."
7800 PRINT
7810 GOSUB Ready_start
7820 ENTER Address;Meas_data
7830 Title$="PULSE FREQUENCY"
7840 GOSUB Sub_title
7850 PRINT
7860 PRINT "VERIFY THE COUNTER DISPLAYS APPROX 1 GHZ PULSE"
7870 PRINT
7880 PRINT
7890 GOSUB Ready_start
7900 Title$="PULSE WIDTH MEASUREMENT"
7910 GOSUB Print_title
7920 OUTPUT Address;"PWID"
7930 OUTPUT Address;"AVER,100"
7940 REMOTE Address
7950 PRINT "CHECKPOINT 16 TESTS THE 'PULSE WIDTH' HP-IB COMMAND."
7960 PRINT
7970 GOSUB Ready_start
7980 ENTER Address;Meas_data
7990 Title$="PULSE WIDTH"
8000 GOSUB Sub_title
8010 PRINT
8020 PRINT "VERIFY THE COUNTER DISPLAYS APPROX .100 MICRO SEC PW"
8030 PRINT
```



```
8040 GOSUB Ready_start
8050 Title$="P OFFT MEASUREMENT"
8060 GOSUB Print_title
8070 OUTPUT Address;"OFFT"
8080 OUTPUT Address;"AVER,100"
8090 REMOTE Address
8100 PRINT "CHECKPOINT 16 TESTS THE 'OFFT' HP-IB COMMAND"
8110 PRINT
8120 GOSUB Ready_start
8130 ENTER Address;Meas_data
8140 Title$="P OFFT TIME"
8150 GOSUB Sub_title
8160 PRINT
8170 PRINT "VERIFY THE COUNTER DISPLAYS APPROX .500 MICRO SEC OFF"
8180 PRINT
8190 GOSUB Ready_start
8200 Title$="PRI MEASUREMENT"
8210 GOSUB Print_title
8220 OUTPUT Address;"PRI"
8230 OUTPUT Address;"AVER,100"
8240 REMOTE Address
8250 PRINT "CHECKPOINT 16 TESTS THE 'PRI MEASUREMENT' HP-IB COMMAND"
8260 PRINT
8270 GOSUB Ready_start
8280 ENTER Address;Meas_data
8290 Title$="PULSE REP INTERVAL"
8300 GOSUB Sub_title
8310 PRINT
8320 PRINT "VERIFY THE COUNTER DISPLAYS APPROX .600 MICRO SEC PRI"
8330 PRINT
8340 GOSUB Ready_start
8350 Title$="PULSE REP FREQUENCY"
8360 GOSUB Print_title
8370 OUTPUT Address;"PRF"
8380 OUTPUT Address;"AVER,100"
8390 REMOTE Address
8400 PRINT "CHECKPOINT 16 TESTS THE 'PRF' HP-IB COMMAND"
8410 PRINT
8420 GOSUB Ready_start
8430 ENTER Address;Meas_data
8440 Title$="PULSE REP FREQUENCY"
8450 GOSUB Sub_title
8460 PRINT
8470 PRINT "VERIFY THE COUNTER DISPLAYS APPROX 1663781 PRF"
8480 PRINT
8490 GOTO Record_results
8500 ! END OF CHK16
8510 Chk17:!
8520 Test_number=17
8530 Title$="CHECK ALL ADDRESSES"
8540 GOSUB Print_title
8550 REMOTE Address
8560 OUTPUT Address;"INIT"
8570 PRINT "Checkpoint 17 tests all of the valid HP-IB addresses except 21, which is"
8580 PRINT "the address of the controller."
8590 PRINT
8600 PRINT "TEST DESCRIPTION"
8610 PRINT
8620 PRINT "EACH ADDRESS TO BE TESTED IS MANUALLY SET ON REAR OF INSTRUMENT. PROGRAM WILL"
8630 PRINT "TEST IT WHEN TEST SOFTKEY IS PRESSED. THEN, NEXT ADDRESS IS SET ON INSTRUMENT,"
8640 PRINT "THE INCR SOFTKEY IS PRESSED TO INCREMENT PROGRAM TO NEXT ADDRESS, AND TEST"
8650 PRINT "IS DONE. A RUNNING TOTAL OF TESTS, PASSES, AND FAILS ARE LOGGED BY THE PROGRAM."
```

```
8660 PRINT
8670 GOSUB Ready_start
8680 Fail_counter=0! Reset fail counter
8690 Pass_counter=0! Reset pass counter
8700 FOR Address=700 TO 730
8710 IF Address=721 THEN GOTO Incr_address
8720 Re_test: I
8730 OUTPUT KBD;CHR$(255)&"K";
8740 LOCAL 7
8750 PRINT
8760 PRINT "On the ";Inst_id$;", SET ADDRESS TO BE TESTED AT REAR PANEL DIP SWITCH,"
8770 PRINT
8780 PRINT "CYCLE POWER TO CAUSE INSTRUMENT TO RECOGNIZED ANY CHANGES MADE."
8790 PRINT
8800 PRINT "WAIT FOR INSTRUMENT TO FINISH POWER UP ROUTINE BEFOR TESTING."
8810 PRINT
8820 PRINT
8830 GOSUB Clear_keys
8840 ON KEY 1 LABEL "INCR" GOTO Incr_address
8850 ON KEY 6 LABEL " " GOTO Incr_address
8860 ON KEY 2 LABEL "EXIT" GOTO Exit_test1
8870 ON KEY 7 LABEL " " GOTO Exit_test1
8880 ON KEY 3 LABEL "TEST" GOTO Test_address
8890 ON KEY 8 LABEL " " GOTO Test_address
8900 PRINT "Press TEST to test current HP-IB address ";Address
8910 PRINT "Press INCR to skip to HP-IB address - ";
8920 IF Address=720 THEN
8930 PRINT Address+2
8940 ELSE
8950 IF Address<>730 THEN
8960 PRINT Address+1
8970 ELSE
8980 PRINT "NONE."
8990 END IF
9000 END IF
9010 PRINT
9020 PRINT
9030 PRINT "PRESS EXIT TO TERMINATE THIS CHECKPOINT."
9040 GOSUB Wait_for_key
9050 Test_address:I
9060 GOSUB Keys_off
9070 ON TIMEOUT 7,3 GOTO No_response
9080 REMOTE Address
9090 OUTPUT Address;"ID?"
9100 ENTER Address;Id_data$
9110 IF Id_data$=Inst_id$ THEN GOTO Incr_pass
9120 No_response:I
9130 OFF TIMEOUT 7
9140 PRINT
9150 Fail_counter=Fail_counter+1! Increment fail counter
9160 Fail_address(Fail_counter)=Address! Store passed address
9170 PRINT
9180 PRINT Inst_id$;" does not respond at address ";Address
9190 BEEP 250,.15
9200 WAIT .1
9210 BEEP 250,.15
9220 PRINT
9230 GOSUB Ready_start
9240 GOTO Re_test
9250 Incr_pass:I
9260 OFF TIMEOUT 7
9270 Pass_counter=Pass_counter+1! Increment pass ctr
```

```

9280 Pass_address(Pass_counter)=Address !Store pass address
9290 PRINT
9300 PRINT Inst_id$;" responds at address ";Address
9310 PRINT
9320 GOSUB Ready_start
9330 GOTO Re_test
9340 Incr_address: !
9350 GOSUB Keys_off
9360 ABORT 7
9370 CLEAR Address
9380 NEXT Address
9390 Exit_test1: !
9400 GOSUB Keys_off
9410 ABORT 7
9420 CLEAR Address
9430 IF Pass_counter=0 THEN GOTO No_pass_addr
9440 OUTPUT KBD;CHR$(255)&"K";
9450 PRINT "The ";Inst_id$;" responded at the following addresses:"
9460 FOR I=1 TO Pass_counter
9470 PRINT " ";Pass_address(I)
9480 NEXT I
9490 No_pass_addr: !
9500 IF Fail_counter=0 THEN GOTO No_address
9510 PRINT
9520 PRINT Inst_id$;" failed to respond at the following addresses:"
9530 PRINT
9540 FOR I=1 TO Fail_counter
9550 PRINT " ";Fail_address(I)
9560 NEXT I
9570 GOTO Finish_address
9580 No_address: !
9590 IF Pass_counter=0 THEN GOTO Finish_address
9600 PRINT
9610 PRINT "No addresses were tested."
9620 Finish_address: !
9630 PRINT
9640 GOSUB Ready_start
9650 OFF TIMEOUT 7
9660 GOSUB Begin_search
9670 GOTO Record_results
9680 ! End of Chk17
9690 !
9700 !
9710 Final_exit: !
9720 PRINT "HP-IB VERIFICATION DONE"
9730 GOTO Exit_opver
9740 Error_exit: !
9750 PRINT ERRMS$
9760 Exit_opver: !
9770 CONTROL 1,12;0
9780 RESET 7
9790 PRINTER IS CRT
9800 STOP ! End of program
9810 !*****
9820 ! SUBROUTINES SECTION
9830 !*****
9840 Begin_search: ! SEARCH FOR 5361A/B ADDRESS
9850 OUTPUT KBD;CHR$(255)&"K";
9860 PRINT "SEARCHING FOR HP COUNTER AT ADDRESS";
9870 ON TIMEOUT 7,.4 GOTO Try_another
9880 FOR Address=700 TO 731
9890 IF Address=721 THEN GOTO Try_another! SKIP CONTROLLER

```

```

9900 IF Address=Ptr_add THEN GOTO Try_another! COUNTER ADDRESS SHOULD NOT BE EQUAL TO THE
      PRINTER ADDRESS
9910 OUTPUT CRT;Address;CHR$(8);CHR$(8);CHR$(8);CHR$(8);
9920 REMOTE Address
9930 OUTPUT Address;"ID?"
9940 ENTER Address;Inst_id$
9950 IF (Inst_id$="HP5361A" or Inst_ID$="HP5361B") THEN GOTO Found_one
9960 Try_another: !
9970 ABORT 7
9980 CLEAR Address
9990 NEXT Address
10000 BEEP 550,.15
10010 WAIT .1
10020 BEEP 150,.15
10030 PRINT
10040 PRINT
10050 PRINT "NO COUNTER WAS FOUND ON THE HP-IB. CHECK ALL CONNECTIONS AND SWITCH SETTINGS."
10060 PRINT
10070 PRINT " BE SURE THAT THE ADDRESS OF THE PRINTER IS NOT THE SAME AS THE COUNTER."
10080 PRINT
10090 PRINT "RESTART PROGRAM"
10100 GOSUB Ready_start
10110 DISP Inst_id$
10120 GOTO Error_exit ! GOTO SKIP_PRINT ! TRY AGAIN
10130 Found_one: !
10140 PRINT
10150 PRINT
10160 PRINT Inst_id$;" FOUND AT ADDRESS ";VAL$(Address);"."
10170 BEEP 800,.03
10180 WAIT 3
10190 OFF TIMEOUT 7
10200 RETURN
10210 Record_results: !
10220 BEEP 800,.03
10230 INPUT "Press ENTER to record the results. ",Dummy$
10240 PRINT
10250 PRINT " Press the appropriate softkey to record the results of CHECKPOINT";
      Test_number;","
10260 GOSUB Clear_keys
10270 ON KEY 1 LABEL " PASS" GOTO Pass_test
10280 ON KEY 6 LABEL " " GOTO Pass_test
10290 ON KEY 4 LABEL " FAIL" GOTO Fail_test
10300 ON KEY 9 LABEL " " GOTO Fail_test
10310 GOSUB Wait_for_key
10320 Pass_test: !
10330 GOSUB Keys_off
10340 Test_results$(Test_number)="PASS"
10350 GOTO Next_checkpoint
10360 Fail_test: !
10370 GOSUB Keys_off
10380 Test_results$(Test_number)="FAIL"
10390 Next_checkpoint: ! Determine next checkpoint to be executed
10400 IF Test_number=18 THEN RETURN
10410 OUTPUT KBD;CHR$(255)&"K";
10420 PRINT "Current checkpoint: ";Test_number
10430 PRINT
10440 PRINT "Press the appropriate softkey to select the desired checkpoint..."
10450 PRINT
10460 PRINT "NEXT - Press K1 to perform the next checkpoint,"
10470 PRINT "EXIT - Press K2 to end the program,"
10480 PRINT "REPEAT - Press K3 to repeat this checkpoint, or"
10490 PRINT "GOTO# - Press K4 to select an arbitrary checkpoint."

```

```

10500 GOSUB Clear_keys
10510 ON KEY 1 LABEL " NEXT" GOTO Next_test
10520 ON KEY 6 LABEL " " GOTO Next_test
10530 ON KEY 2 LABEL " EXIT" GOTO Exit_test
10540 ON KEY 7 LABEL " " GOTO Exit_test
10550 ON KEY 3 LABEL " REPEAT" GOTO Repeat_test
10560 ON KEY 8 LABEL " " GOTO Repeat_test
10570 ON KEY 4 LABEL " GOTO #" GOTO Test_entry
10580 ON KEY 9 LABEL " " GOTO Test_entry
10590 GOSUB Wait_for_key
10600 First_check: ! Determines the first checkpoint to execute
10610 OUTPUT KBD;CHR$(255)&"K";
10620 PRINT "Press the softkey to select the desired checkpoint."
10630 PRINT
10640 PRINT "FIRST - Press K1 to perform the first checkpoint,"
10650 PRINT "EXIT - Press K2 to end the program, or"
10660 PRINT "GOTO# - Press K4 to select an arbitrary checkpoint."
10670 GOSUB Clear_keys
10680 ON KEY 1 LABEL " FIRST" GOTO First_test
10690 ON KEY 6 LABEL " " GOTO First_test
10700 ON KEY 2 LABEL " EXIT" GOTO Exit_test
10710 ON KEY 7 LABEL " " GOTO Exit_test
10720 ON KEY 4 LABEL " GOTO #" GOTO Test_entry
10730 ON KEY 9 LABEL " " GOTO Test_entry
10740 GOSUB Wait_for_key
10750 Key_trap: !
10760 DISP "Wrong key pressed. Try again.";CHR$(7)
10770 RETURN
10780 Wait_for_key: !
10790 CONTROL 1,12;0
10800 DISP
10810 Loop:GOTO Loop
10820 Keys_off: !
10830 CONTROL 1,12;1
10840 RETURN
10850 Ready_start: !
10860 BEEP 800,.03
10870 INPUT "Press ENTER to continue. ",Dummy$
10880 RETURN
10890 Print_title: ! Display checkpoint title
10900 OUTPUT KBD;CHR$(255)&"K";
10910 PRINT
10920 PRINT TAB(34);"CHECKPOINT";Test_number
10930 GOSUB Sub_title
10940 PRINT Horiz_line$
10950 BEEP 800,.03
10960 INPUT "Press ENTER to start the test.",Dummy$
10970 OUTPUT KBD;CHR$(255)&"K";
10980 RETURN
10990 Sub_title: !
11000 PRINT
11010 PRINT
11020 PRINT
11030 PRINT
11040 PRINT TAB(INT((80-(LEN(TRIM$(Title$)))/2));Title$
11050 RETURN
11060 First_test: !
11070 GOSUB Keys_off
11080 Checkpoint=1
11090 GOTO Branch_checkpt
11100 Next_test: !
11110 GOSUB Keys_off

```

```
11120 Checkpoint=Test_number+1
11130 GOTO Branch_checkpt
11140 Exit_test:|
11150 Checkpoint=0
11160 GOTO Branch_checkpt
11170 Repeat_test:|
11180 GOSUB Keys_off
11190 Checkpoint=Test_number
11200 GOTO Branch_checkpt
11210 Test_entry:|
11220 GOSUB Keys_off
11230 OUTPUT KBD;CHR$(255)&"K";
11240 Title$="CHECKPOINT SUMMARY"
11250 GOSUB Sub_title
11260 PRINT
11270 GOSUB Menu
11280 INPUT "Type the checkpoint number desired (1 to 17), and press ENTER. ",Test_number
11290 IF (Test_number <1) OR (Test_number >17) THEN GOTO Integer_error
11300 Checkpoint=Test_number
11310 GOTO Branch_checkpt
11320 Integer_error:|
11330 DISP "Please enter an integer only, 1 through 17.";CHR$(7)
11340 GOTO Test_entry
11350 Branch_checkpt:|
11360 IF (Checkpoint=0 OR Checkpoint=18) THEN GOTO Print_results
11370 ON Checkpoint GOTO Chk1, Chk2, Chk3, Chk4, Chk5, Chk6, Chk7, Chk8, Chk9, Chk10, Chk11,
Chk12, Chk13, Chk14, Chk15, Chk16, Chk17
11380 Print_results:|
11390 PRINTER IS CRT
11400 OUTPUT KBD;CHR$(255)&"K";
11410 PRINT "Do you wish to have a hardcopy of the results?"
11420 GOSUB Clear_keys
11430 ON KEY 1 LABEL " YES" GOTO Print_it
11440 ON KEY 6 LABEL " " GOTO Print_it
11450 ON KEY 4 LABEL " NO" GOTO No_print
11460 ON KEY 9 LABEL " " GOTO No_print
11470 GOSUB Wait_for_key
11480 RETURN
11490 Clear_keys: |
11500 CONTROL 1,12;0 | KEY LABELS ON
11510 ON KEY 0 LABEL " " GOSUB Key_trap
11520 ON KEY 1 LABEL " " GOSUB Key_trap
11530 ON KEY 2 LABEL " " GOSUB Key_trap
11540 ON KEY 3 LABEL " " GOSUB Key_trap
11550 ON KEY 4 LABEL " " GOSUB Key_trap
11560 ON KEY 5 LABEL " " GOSUB Key_trap
11570 ON KEY 6 LABEL " " GOSUB Key_trap
11580 ON KEY 7 LABEL " " GOSUB Key_trap
11590 ON KEY 8 LABEL " " GOSUB Key_trap
11600 ON KEY 9 LABEL " " GOSUB Key_trap
11610 RETURN
11620 Menu:|
11630 CONTROL 1,12;1
11640 Title$="5361A/B CHECKPOINT SUMMARY"
11650 GOSUB Sub_title
11660 PRINT
11670 PRINT " 1 'REMOTE', 'LOCAL LOCKOUT', 'LOCAL' ** 9 'SAMPLE' and 'TRIGGER'"
11680 PRINT " 2 Self Check ('TEST?') ** 10 'RESOL' and 'HIRESOL'"
11690 PRINT " 3 'DISPLAY' ** 11 'OFFSET', 'SCALE', and 'SMOOTH'"
11700 PRINT " 4 'INIT' and 'RESET' ** 12 'AUTO' and 'MANUAL'"
11710 PRINT " 5 'REF' and 'OVEN' ** 13 'FMRATE'"
11720 PRINT " 6 'ERR?' ** 14 'SRQMASK'"
```

```
11730 PRINT " 7 'SET' and 'SET?' ** 15 'DUMP'"
11740 PRINT " 8 'LOWZ' and 'HIGHZ' ** 16 'PULSE MEASUREMENT"
11750 PRINT " ** 17 'CHECK ALL ADDRESS'"
11760 RETURN
11770 Print_it:|
11780 GOSUB Keys_off
11790 OUTPUT KBD;CHR$(255)&"K";
11800 PRINTER IS Ptr_add
11810 ON ERROR GOTO Prnt_stuck
11820 ON TIMEOUT Ptr_add DIV 100,1 GOTO Prnt_stuck
11830 OUTPUT Ptr_add USING "#,K"; " ! TEST FOR RESPONSE
11840 OFF TIMEOUT
11850 OFF ERROR
11860 GOTO No_print
11870 Prnt_stuck:|
11880 CONTROL 1,12;1
11890 DISP (Ptr_add); " NOT RESPONDING. CHECK PRINTER IS ON, & ADDRESS & HOOK-UP IS CORRECT. "
11900 BEEP 600,.3
11910 WAIT 3
11920 OFF TIMEOUT
11930 OFF ERROR
11940 GOTO Print_results
11950 No_print:|
11960 GOSUB Keys_off
11970 OUTPUT KBD;CHR$(255)&"K";
11980 Title$="CHECKPOINT RESULTS"
11990 GOSUB Sub_title
12000 PRINT Horiz_line$
12010 PRINT
12020 PRINT "Counter: ";Inst_id$;" at address";Address
12030 PRINT
12040 FOR Test_number=1 TO 8
12050 PRINT " ";Test_number;TAB(8);Test_results$(Test_number);
12060 PRINT TAB(30);8+Test_number;TAB(34);Test_results$(8+Test_number)
12070 NEXT Test_number
12080 PRINT TAB(30);17;TAB(34);Test_results$(17);
12090 PRINT
12100 PRINT
12110 PRINTER IS CRT
12120 OUTPUT Address;"INIT"
12130 LOCAL 7
12140 GOTO Final_exit
12150 END
```





# ADVANCED MEASUREMENTS AND PROFILING

---

## APPENDIX GUIDE

This appendix provides you with information about complex or specialized measurement techniques. The procedures may require you to provide either a gating or arming signal to the front panel GATE/ARM IN connector from an external source. Alternatively, you may need additional knowledge of the input signal as during chirped radar-pulse frequency measurements. The Auto Profiling capabilities of the HP 5361B are also explained for both frequency and phase measurements.

External gating and arming are compared and discussed in concept then explained in detail. External gating is first followed by external arming and chirped radar-pulse frequency measurements. A discussion of Frequency and Phase Profile measurement considerations follows information about gating and arming. Examples of signal timing and monitoring are shown in *Figure D-1, GATE/ARM IN Timing Waveforms* and *Figure D-3 Profile Timing Waveforms*.

### Where to Find Important Topics

- |                                |          |
|--------------------------------|----------|
| ■ Extended Function 96         | pg. D-6  |
| ■ External Arming Connection   | pg. D-6  |
| ■ External Gating Connection   | pg. D-3  |
| ■ External Measurement Control | pg. D-2  |
| ■ Signal/Gate-Arm Monitoring   | pg. D-2  |
| ■ Timing Waveforms             | pg. D-4  |
| ■ Profile Timing Waveforms     | pg. D-11 |

### Appendix Summary

- |                                    |          |
|------------------------------------|----------|
| ■ Why You May Need                 |          |
| External Gating or Arming          | pg. D-2  |
| ■ The SCOPE-VIEW Output            | pg. D-2  |
| ■ External Gating Details          | pg. D-2  |
| ■ External Arming Details          | pg. D-5  |
| ■ Chirped-Pulse Measurements Using |          |
| Extended Function 96               | pg. D-6  |
| ■ Pulse/CW Frequency Profiling     | pg. D-7  |
| ■ Pulse/CW Phase Profiling         | pg. D-18 |

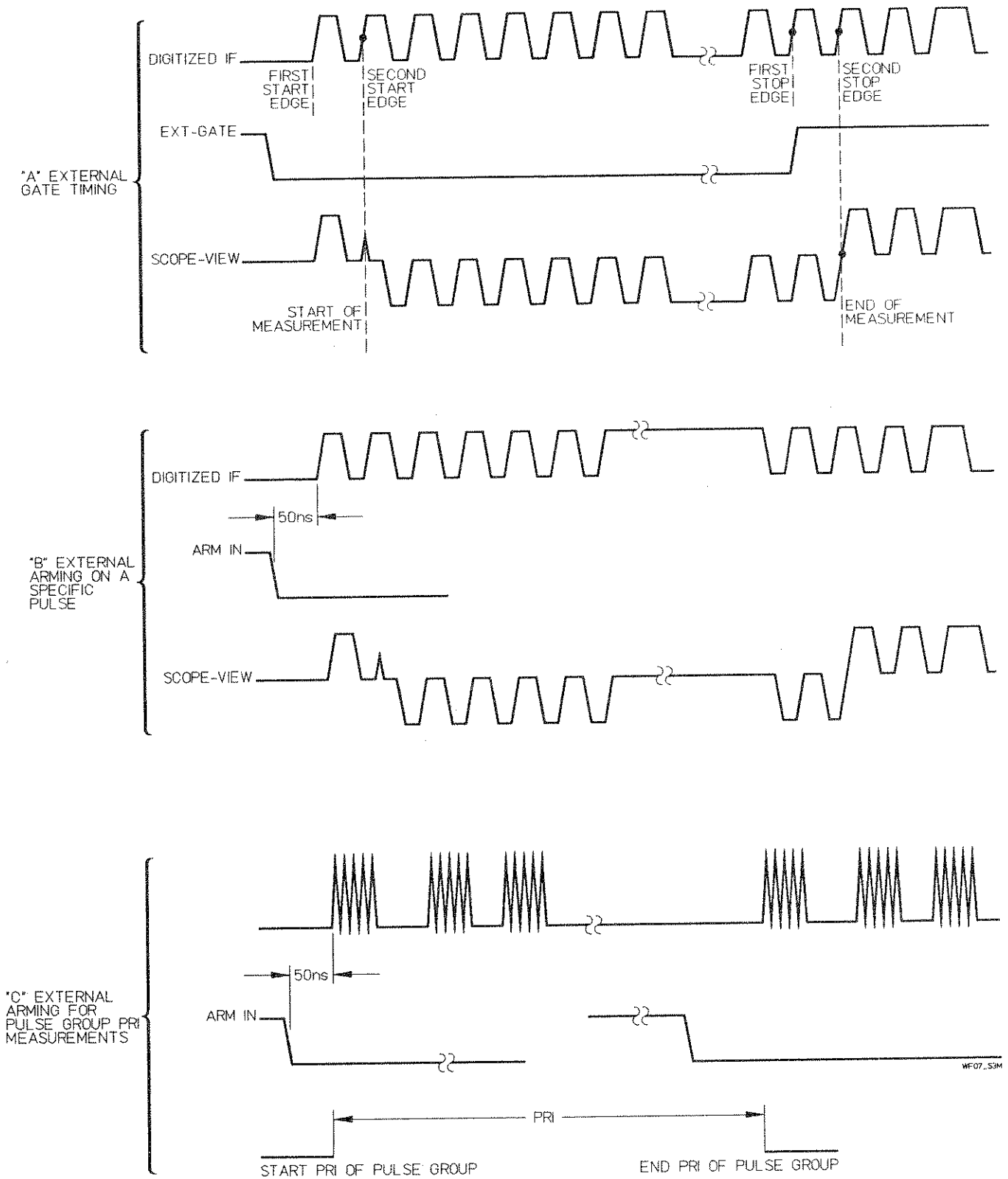

Figure D-1. GATE/ARM IN Timing Waveforms

## Gate Width vs Accuracy

External Gates as narrow as 20 ns can be used. This translates to measurements that are 1 or 2 IF cycles in length. There is a tradeoff between accuracy and the gate width. Therefore, it may be preferable to set the gate width to 100 nanoseconds and have overlapping gates when profiling rather than having a series of 50 nanosecond gates that are contiguous, that is, the gates will not overlap in time.

In general, the largest gate width should be used that meets the requirements of the total sweep over which a frequency measurement is made along with the need to resolve details of the frequency profile. In addition to providing greater accuracy, gate widths of 100 ns (or more) permit the counter to automatically acquire the signal and keep it within the IF passband. Typical numbers that may help in making these decisions are shown in the example below.

With a typical gate bias of 100 ps and a 100 ns gate width, the error is:

$$\frac{\text{Gate Bias}}{\text{Gate Width}} \times \text{Nominal IF} = \frac{100 \text{ ps}}{100 \text{ ns}} \times 70 \text{ MHz} = 70 \text{ kHz}$$

When the gate width is only half as wide, the error becomes:

$$\frac{100 \text{ ps}}{50 \text{ ns}} \times 70 \text{ MHz} = 140 \text{ kHz}$$

As you can see, the shorter gate produced twice as much error.

## Other Considerations

Because of the internal delays for different signals within the instrument, there is a limitation on how early you can remove the external gate prior to the end of a pulse. During usual operation, the external gate shouldn't be removed earlier than 50 ns from the start of the pulse. You can still use a 20 ns wide external gate as long as this requirement is met. The following information is provided to explain how this requirement affects typical measurements in either the Auto or Manual modes:

In AUTO mode, the external gate should be at least 60 ns wide. Hence, in AUTO mode, the requirement doesn't apply. If you are making measurements in the MANUAL mode, you can obtain greater accuracy for profiling pulse frequency by using a wider gate pulse as explained earlier. If you are in MANUAL mode and know that the input signal frequency is within 25/30 MHz of the programmed (set) center frequency, you can use extended function 63 to disable all internal IF range checks. This action removes the 50 ns gate requirement altogether. When EFUN 63 is active, the counter cannot automatically acquire the input signal.

External gating controls only the timing of the gate used to measure frequency. It won't affect any other measurements such as pulse envelope parameters or measurements made via Input 2. All Math Functions are usable as well as Extended Functions. Due to the pulsed

nature of this measurement, none of the FM Modes nor Track Mode are available as would normally be the case with CW. You will also see the PULSE message in the right hand portion of the display whenever external gate frequency measurements are being made. Acquisition times are similar to those normally encountered for pulsed signals equal (or greater than) in width to the gate.

## EXTERNAL ARMING DETAILS

To enable the Arming Mode of operation, press the GATE MODE key in the Control/Data key group. The annunciators in the LCD display will cycle through the three gate mode selections. Make sure that it stops at the "ARM" annunciator.

### Connecting the External Arm Signal

The Arming signal must also drive a 1.5 k $\Omega$  load to 3.6 volts as does the gating signal. Sources that drive a 50  $\Omega$  load need to be terminated so that the input level is compatible with TTL or CMOS logic (0 to +3 - +5 volts). The arming signal activates the counter on the "falling edge" of the arming input. Since most measurements require averaging, the arming edge needs to be applied prior to every measured pulse.

### Timing the External Arming Signal

Pulse frequency measurements (See *Figure D-1/B*) can easily be made by providing an arming edge 50 ns prior to the pulse of interest. The actual gate used is automatically set by the counter. You can monitor this via the SCOPE-VIEW output. The display shows how the counter measures only pulses of interest while rejecting all others.

In addition to measuring frequency, arming will also allow some unique and useful pulse envelope measurements. Pulse width measurements can also be made using the Arming Mode by, again, applying a falling edge 50 ns prior to the pulse of interest.

A measurement that can be quite useful is to determine the PRI of a pulse group, that is, the PRI of the groups (See *Figure D-1/C*). You can do this by using the ARM gate mode, but this time the counter is armed prior to each group. This requires two arming edges per measurement, the first to start the PRI measurement at the first group and the next arming edge to end the PRI measurement at the next pulse group. The process must be repeated according to the number of averages set.

### Chirped Pulse Measurements Using Extended Function 96

You can measure chirped radar pulses by using extended function 96. Extended Function 96 causes the HP 5361B to accommodate FM modulation or "chirp" present within the pulse burst. (10 MHz p-p in AUTO mode and 50 MHz p-p in MANUAL mode.) The HP 5361B

determines the carrier frequency of the pulse burst as the average frequency during the gate time. It makes this determination by generating a gate that does not exceed the length of the pulse burst.

The linear, uni-directional frequency change present in a chirp modulated signal requires a shorter gate time to ensure that the pulse burst has not ended before the gate has closed. This is what extended function 96 will do. Extended function 96 toggles ON or OFF and can be selected by pressing SET/ENTER, EXTEND FUNCT, 9, 6, SET/ENTER.

Two of the gate width related extended functions, EFUN 90 (set gate width in time) and EFUN 95 (set gate width by IF events) override EFUN 96. Toggling EFUN 96 has no effect on the measurement if either EFUN 90 or 95 width value is not zero. Therefore, when using EFUN 90 or 95 you must account for any chirp on the input signal and adjust the entered width value accordingly. Failure to do so may result in a gate width chosen by the counter that is longer than the pulse width of the input signal. If you suspect this, you can reprogram the gate width by examining the Scope-View output on an oscilloscope.

## PULSE/CW FREQUENCY PROFILING

Frequency profiling lets you look at signal frequency changes over your specified time range or the power-up default. The signal at INPUT 1 must be repetitive for this measurement process. The output results appear as a frequency vs time plot or table. In general, all other counter functions still operate as usual (Math functions, Manual/Auto, Sample Rate and the like).

You can use frequency profiling in one of two ways. The key distinction is the way you define Time Zero. (Refer to *Figure D-3, Profile Timing Waveforms*.) For pulsed signals this can be the beginning of the pulse. For "non pulsed" signals, another way of defining Time Zero is required. Here you can use the falling edge of an external gate signal to define Time Zero. This also works in cases where the signal is actually pulsed but you don't want to start (or reference) your measurement at the leading edge of the pulse.

The default values chosen by the HP 5361B will usually provide you with a good picture of frequency changes during the pulse or external gate window. The counter selects approximately 50 data points for the plot and scales it appropriately. It sends the plot (or tabular) information to a printer or, transfers the time and frequency information to a controller via HP-IB.

## Setting Up For Profiling

The HP 5361B can output the tabular or graphic profile data to a compatible printer. To do this, follow these simple steps: (Also see the Auto Pulse Profiling application example in section 1.)

- Set the sample rate to HOLD by pressing SET/ENTER, SAMPLE RATE, DEC, keys until the HOLD annunciator is lit, then press SET/ENTER.
- Connect a cable (model 10833A, 1 metre) from the HP-IB connector on the rear of the 5361B to one of the compatible printers (ThinkJet, QuietJet, or PaintJet — see EFUN 72).
- Set the printer to Listen Only Mode. This is done by setting the HP-IB address switch to “Listen Always” on the back of the printer, then cycling ac power.
- Now set the 5361B to Talk Only by setting the HP-IB address to 31. This can be done through the front panel using the key sequence SET/ENTER, HP-IB Address, 3,1, SET/ENTER.
- Press the FREQUENCY/PROFILE key once. (The entire profile sequence is explained in the next few paragraphs.)
- Select the desired resolution by pressing SET/ENTER, RESOLUTION, INC/DEC, SET/ENTER.
- When you want to begin the profiling process, press the TRIGGER key.

The counter can now send Graphic profile data to the printer. After the printer has completed its hardcopy printout, you can begin another profile measurement by pressing the TRIGGER key.

## Turning On the Profiling Function

Profiling is accessed the same way as the other measurement functions in the Function Key Group. The top key is labeled FREQUENCY/PROFILING. When the counter powers up it's in the Frequency Mode. Turn-on the Profiling Mode by pressing the Frequency/Profiling key. If you press this key again the counter toggles back to the Frequency measurement function.

You'll observe the word PROFILING- - - shown on the display while the counter is performing the profiling measurement. The profiling process can be observed by connecting the front panel SCOPE-VIEW output to any 100 MHz scope input. When the profiling process is over, the counter displays the average frequency over the profiling window.

If you're attempting to profile a CW sweep signal, you must provide the 5361B with an external gating input via the front panel Gate/Arm In connector. An active low TTL gate signal will define the window during which profiling occurs. Ensure that the counter's Gate mode is External by pressing the GATE MODE key once or twice (as needed) until the External gate annunciator (EXT) is lit.

As with regular pulse measurements, Extended Functions can be used to enhance and customize measurement details to fit your needs. Extended Functions 81 - 89 are specifically designed to give you added profiling flexibility and are described further in this section.

## Interpreting Printed Hardcopy Results

Figure D-2 shows an example of the printed frequency profile plot output.

The frequency axis of the plot is scaled by the minimum and maximum values of the frequency measured and by determining a convenient scale factor (frequency per division). In general, increasing the average step width will increase the frequency resolution while trading-off the risetime response for a frequency hop. The scaling process also uses unfiltered data. The frequency spread of filtered data is typically a fraction of the frequency range on the entire grid.

The time axis is automatically scaled based on start and stop times of the profile. Since the scale factor is set to a power-of-ten multiple of one, two, or five, the end of the plot axis typically exceeds the last plot data point. Each frequency data point is assigned to the start of the time interval.

When doing Externally Gated Profile measurements, the falling edge defines "time zero". Figure D-3, Profile Gate Timing shows the timing relationships involved in the Frequency profiling process with or without the presence of an external gate signal. Extended Functions 81 or 88 can also be used to set a delay from the External Gate "time zero" edge.

The ability to resolve small frequency changes in a pulsed signal is largely a function of the effective step or gate width. For the HP 5361B, this value appears under "Gate Information" on the frequency profile plot.

As the step size increases in time, the frequency resolution (or the ability to accurately measure small changes in frequency) gets better but the time domain resolution gets worse. The transition times of abrupt hops in frequency are degraded. You must decide which to optimize.

## Modifying the Measurement

You can customize the profile measurement process in ways similar to the other more standard Pulse/CW measurement functions. To start out, you may want a specific resolution or an identification prefix number for your hardcopy output. You may also want to start and stop your profile measurement exactly where you want rather than the default values.

The following paragraphs discuss how to make these measurement modifications and more:

### RESOLUTION

Change the resolution in the usual way by pressing SET/ENTER, RESOLUTION, and then pressing the INC or DEC arrow keys until you have the resolution desired, then press SET/ENTER.

### SET START TIME

The default start time is zero. This is defined at the leading edge of the pulse for internally gated measurements or the falling edge of the External Gate for externally gated measurements (see *Figure D-3*).

You can specify the beginning of the profiling measurement by calling Extended Function 81. Just press SET/ENTER, EXTENDED FUNCTION, 8,1, SET/ENTER. Now key in the value of Start Time you want to use and press SET/ENTER. This extended function uses the default units of microseconds.

You may also select another time unit by terminating the entry with one of the other numeric terminator keys such as nanoseconds or milliseconds. A decimal point must be within the first 4 digits if the entry is to be more than 4 digits long. The maximum value for Start Time is 9.999999 milliseconds.

### NOTE

---

*Extended functions 81 and 82 require short-term signal stability of 70 kHz. If errors occur while attempting use of these extended functions because of input signal instability, you can still use Efuncs 87, 88, and 89 to set up the measurement. The IF period will be 14 ns, nominal.*

*Refer also to the Note on page D-16 when using Efuncs 87, 88, 89, along with 91.*

---

### SET STOP TIME

The default stop time is approximately 85% of the pulse width or 85% of the External Gate width. The Stop time can be decreased below this default value by invoking Extended Function 82. (See *Figure D-3*.)



Call this function by pressing SET/ENTER, EXTENDED FUNCTION, 8, 2, SET/ENTER. The default unit of microseconds is used if SET/ENTER is pressed after the Stop time is entered. You may also select another time unit by terminating the entry with one of the other numeric terminator keys such as nanoseconds or milliseconds.

A decimal point must be within the first 4 digits if the entry is to be more than 4 digits long. The maximum value for Stop Time is 9.999999 ms. (You may also use Extended Function 90 or 95 to increase the default Stop time past the 85 percent pulse width limit along with Efun 82.)

#### NUMBER OF DATA POINTS

The default value for the number of data points is nominally 50 (FINE). The actual value can range from 37 to 75. If you want only a quick profile, use the COARSE profile rather than FINE profile.

This is a toggle function and can be switched from FINE (Default) to COARSE by calling Extended Function 83. Just press SET/ENTER, EXTENDED FUNCTION, 8, 3, SET/ENTER. The display briefly shows "COARSE DATA".

A COARSE profile consists of approximately 10 data points over the same time window. Setting the data points back to FINE is done by once again calling Extended Function 83 as described above. If there are fewer IF cycles in the pulse than the FINE or COARSE nominal value, then the number of data points will be less.

#### OUTPUT CONTROL

The default output sends graphic data to the printer when the HP-IB interface is properly configured and connected. You can also get just a table, or both a plot and table by controlling the output modes with Extended Function 84.

Just press SET/ENTER, EXTENDED FUNCTION, 8, 4, SET/ENTER. The display shows an asterisk denoting BOTH, PLT, or TBL. By entering the desired numeric choice (0,1,or 2) you can select the output mode. You'll need to terminate entry by pressing SET/ENTER.

#### FILTER

The FILTER function lets you obtain cleaner looking hardcopy results for slow frequency changes and data that is close to the counter's resolution capability. The filter is most useful when measuring signals that do not change rapidly compared to the average step width. The filter also helps improve the noise floor of the counter allowing better frequency resolution.

The FILTER function is ON as its default status. If you need to be able to plot very fast transitions in frequency, you can turn the filter OFF. This function toggles and is switched by calling Extended Function 85.

Just press SET/ENTER, EXTENDED FUNCTION, 8, 5, SET/ENTER and momentarily observe FILTER OFF on the display. Calling this extended function again turns the filter back ON. The

step response of the filter produces a frequency transition (rise time) which is about 5 data points wide.

The filter used for plotting tracks the average step width. The maximum rise time of a frequency hop as measured by the counter with the filter OFF is approximately equal to the average step width shown on the profile plot under Gate Information. This rise time increases by approximately 5 times when the filter is ON.

#### **PLOT ID PREFIX**

Hardcopy plots are identified by consecutive reference numbers for your convenience. In addition to this numbering, you can add a six digit prefix. This feature can be used to identify a month/day/year, a project code number, or a unit serial number. You can use this feature by calling Extended Function 86.

Just press SET/ENTER, EXTENDED FUNCTION, 8, 6, SET/ENTER, and then key in the six digits and press SET/ENTER (This entry resets the suffix counter to 0001.). The running suffix counter can also be reset by pressing SET/ENTER, RESET which performs the same function as the INIT command via HP-IB. It is reset again when the instrument is turned OFF.

#### **Full Manual Control**

For those situations where the above Profiling options do not provide all the flexibility you may need, five additional extended functions are available. They are:

- 87 - Set the Number of Data Points (Steps) for Frequency Profile
- 88 - Set the Start IF Cycle for Frequency Profile
- 89 - Set the Number of IF Cycles Per Step for Frequency Profile
- 90 - Set Gate Width in Time
- 95 - Set Gate Width by Events (IF cycles)

The details of how Extended Functions 87, 88, and 89 operate follow after a brief discussion of how to customize the default settings.

---

**CAUTION**

---

***There is no error checking when Extended Functions 87, 88, or 89 are enabled so you must use caution to ensure that you are taking the measurement you want to make. It is possible to profile right off the end of the pulse, which will give you incorrect results.***

***These three extended functions (87/88/89) must be used together. When valid choices are loaded for all of them, they are used in the profiling measurement. If any have invalid parameters loaded, the counter will instead use the default values.***

---

## Customizing The Default Settings

The 5361B always programs fewer IF cycles than the pulse actually contains. This ensures that the profiling operation doesn't "fall off the back edge" of the pulse. Profiling must always end before the trailing edge of the pulse (see *Figure D-3*).

Many "interesting" frequency transients occur at the leading edge of the pulse. However, you may occasionally want a closer look at the trailing edge of the pulse. Here are some ways you can do this.

- Extended Function 90 lets you to set the "time" of the measurement end. This "time" estimate can be in error depending on the amount of chirp or frequency hop on the signal. You can make a quick check of the manually set time by doing a frequency measurement using Extended Function 90 to set the time. If the display shows "0", then the time set was too long. You can see this by viewing the Scope-View output with an oscilloscope.
- A good starting point is to make a pulse width measurement and use this value minus about 60 ns. Monitor the measurement from the front panel SCOPE-VIEW output to observe gate-end in relation to the trailing edge of the pulse. Extended Function 95 also sets the back edge of the Gate but is programmed in IF cycles rather than time.
- Once a correct pulse frequency measurement is made with the chosen value as the maximum gate time, you can profile using Extended Function 90. Under these conditions, you can expect the profiling process to use this same maximum Gate time.
- To customize the progressive step-wise profiling process use these extended functions. Be sure to observe the Note below concerning parameter combinations for these three extended functions. Remember, if you set a value for one of these functions, you must program the others with appropriate values.

### SET NUMBER OF DATA POINTS

The number of profile data points (steps) can be set to any specific value between 1 and 99. This is done by calling Extended Function 87 and entering the desired Number Of Data Points.

### SET START IF CYCLE

You can start the profile measurement on a specific IF cycle. This is entered as an integer between 0 and 999999. The number is entered by calling Extended Function 88.

### SET NUMBER OF IF CYCLES PER STEP

This Extended Function sets the step size for profiling. This can be any value from 1 to 999999. The number is entered by calling Extended Function 89.

### NOTE

---

*When using extended functions 87, 88, 89, along with 91 and the final time exceeds 3 ms, you must set the number of averages (Efun 91) so that its product with the maximum time is less than 10 seconds.*

---

### OUTPUT TABLE FORMAT

Figure D-4 shows an example of the printed frequency profile table output. The tabular frequency data, like the plot, is assigned to the beginning of the profile interval. Therefore, a plot that starts at zero will assign the first frequency value to this same time beginning interval.

The tabular data is not filtered but is the actual calculation of frequency for that time window.

When setting the start and stop times with Extended Function 81 and 82 respectively, the ACTUAL time of start and stop is shown rather than the particular time that you entered. The actual time is typically within 10 ns of your specified value.

The number of digits in the printed frequency is determined by the resolution you've set.

FREQUENCY PROFILE		ID = 000000.0002
TIME (ns)	PROFILE FREQUENCY (Hz)	
0	1.3450523469E+10	
922	1.3450783996E+10	
1840	1.3450883109E+10	
2757	1.3450940098E+10	
3673	1.3450974103E+10	
4589	1.3450994568E+10	
5505	1.3451016494E+10	
6420	1.3451031446E+10	
7335	1.3451044722E+10	
8250	1.3451047673E+10	
9165	1.3451062612E+10	
10079	1.3451063648E+10	
10994	1.3451070770E+10	
11909	1.3451082403E+10	
12823	1.3451082973E+10	
13738	1.3451086341E+10	
14652	1.3451092924E+10	
15566	1.3451093987E+10	
16481	1.3451100493E+10	
17395	1.3451110994E+10	
18309	1.3451103501E+10	
19223	1.3451112602E+10	
20137	1.3451109542E+10	
21051	1.3451111876E+10	
21965	1.3451127984E+10	
22879	1.3451124534E+10	
23793	1.3451138908E+10	
24707	1.3451129489E+10	
25620	1.3451121808E+10	
26534	1.3451144566E+10	
27448	1.3451137533E+10	
28362	1.3451134185E+10	
29275	1.3451157521E+10	
30189	1.3451139350E+10	
31103	1.3451160663E+10	
32016	1.3451148850E+10	
32930	1.3451150122E+10	
33843	1.3451161157E+10	
34757	1.3451149680E+10	
35670	1.3451175209E+10	
36583	1.3451170585E+10	
37497	1.3451170273E+10	
38410	1.3451161105E+10	
39323	1.3451175390E+10	
40237	1.3451183211E+10	
41150	1.3451165779E+10	
42063	1.3451176170E+10	
42976	1.3451194334E+10	
43889	1.3451177625E+10	

Figure D-4 . Frequency Profile Table Output Example

## Making a “Spot Frequency” Measurement Within the Pulse Burst.

At times it is useful to measure frequency somewhere within the pulse without requiring the full profile information. One example of this is to verify that the settling time of a VCO is within specifications.

To do this, you can set the start and stop times (Efuns 81 and 82) to define your window of interest (see *Figure D-3*).

Now set the 5361B to profiling mode and take a measurement. The displayed frequency is the average frequency during the specified interval. Improved resolution and accuracy can be obtained by specifying a larger window in time. Setting both the start and stop to the same value defaults to a single IF cycle measurement which will be approximately 14 ns.

For making “Spot Frequency” measurements with a time window greater than 100 ns, it’s quicker to set Extended Function 83 (Coarse/Fine) to COARSE. The displayed measurement uses the end points to compute the average frequency for this window.

## PULSE/CW PHASE PROFILING

The HP 5361B can also profile changes in the “phase” of a pulsed or CW signal. This capability requires the use of an instrument controller to manipulate the phase data provided by the HP 5361B. Specialized HP-IB command queries extract signal information that is analyzed by the phase profiling program that can be entered into the Controller.

Before going further, be sure you’ve read the previous discussion of frequency profiling. The following information and procedures about phase profiling assume that you have some understanding of how the HP 5361B Gating and extended functions for profiling operate.

- Connect the HP 5361B to any suitable HP 9000 Series 300/200 instrument controller via the counter’s HP-IB interface bus.
- Load the program listed in Application Note 377-4. You can also reference this Note for more detailed information about phase profiling.

As mentioned above, with the use of an instrument controller and a few simple commands and calculations, the 5361B has the capability of measuring the phase deviation of your microwave signal.

The advantages of the technique described here is that it doesn’t require a reference phase. Only the signal under test need be accessed. The counter automatically acquires the signal anywhere within the range of the microwave band and gathers the data over the time window you want. All of the flexibility available for Frequency Profiling is also available for phase profiling.

This measurement capability is unique to this class of instrument and can be useful in measuring phase modulated signals and measuring settling time for coherent/phase locked systems that are frequency agile.

The HP 5361B doesn't replace high precision network analyzers. Phase error and measurement noise may limit the usefulness of these measurements when applied to high frequency signals.

With use of the PROFTIME command, the counter outputs the values of IF zero crossings. These values can be used as explained to construct a phase vs time or phase profile plot.

## Obtaining The Output

You can obtain the output value by making successive READs over the HP-IB interface. The next READ after the last data block is EOT indicating the end of the table. This data is stored in an array for further processing.

## Interpreting The Output

The measurement output data points refer to the time values (in nanoseconds) of the IF zero crossings, multiplied by the number of averages. Since sampling (the down conversion process used in the 5361B) preserves phase, the phase of the IF is the same as the microwave signal at INPUT 1.

To get the real time, simply divide by the number of averages. The number of averages can be obtained from the 5361B by sending the PROFAVG ? query to the counter.

## Other Data For Phase

Now that we have the actual IF zero crossing "event time", we still need to determine when the IF zero crossings should have occurred or, the "expected IF zero crossing event time(s)". Since this measurement is a differential phase measurement, where phase change is a function of time, the reference is whatever you choose it to be. For this example the reference phase will be zero degrees.

Other variables that are useful for this measurement are:

- Harmonic number HARM?
- IF cycles per measurement IFPER?
- Local Oscillator Frequency LO?
- Side Band SIDEBAND?

The Data output will typically look like the following:

Data	Implied Step Number
0	0
xxxxxx = First Data	1
xxxxxx	2
xxxxxx	3
.	.
.	.
xxxxx = Last Data	N
EOT	

The Last data is followed by an EOT denoting the end of the data file.

Use the following HP-IB commands to retrieve the final information needed to compute phase.

- PROFAVG? (Number of Averages per step)
- IFPER? (Number of IF Periods per step)
- HARM? (Harmonic number?)
- SIDEBAND? (Upper or Lower?)
- LO? (Local Oscillator Frequency?)

If a reference frequency (in Hz) is specified, the corresponding IF reference must be computed with the following equation(s):

$$\text{IF ref} = (\text{Ref. freq.} - \text{Harmonic N} * \text{LO}) * 10^{-6} \text{ MHz (Upper sideband)}$$

— OR —

$$\text{IF ref} = -(\text{Ref. freq.} - \text{Harmonic N} * \text{LO}) * 10^{-6} \text{ MHz (Lower sideband)}$$

For measurements where the frequency is relatively constant, an estimate of the average IF can be used instead using the following formula:

$$\text{IF est} = \frac{(\text{PROVAVG}) * (\text{N}) * (\text{IFPER}) * 1000}{\text{Last Data} - \text{First Data}} \text{ in MHz}$$



First Data is typically zero unless the start of the profile or phase measurement has been set to other than zero using Extended Function 81 or 88.

Now the phase ( $\theta$ ) can be calculated at each point in time where a measurement was made with the following formula:

$$T(n) = \frac{\text{Data}(n)}{(\text{PROFAVG}) * (1000)} \text{ in microseconds}$$

$$\theta(n) = [(n) * (\text{IFPER}) - T(n) * (\text{IF est})] * 360 \text{ (for upper sideband)}$$

$$\theta(n) = -[(n) * (\text{IFPER}) - T(n) * (\text{IF est})] * 360 \text{ (for lower sideband)}$$

Where  $n$  is the step number ranging from 1 to  $N$ .

The formula can be read as:

The phase at point ( $n$ ) is the number of cycles that occurred up to  $T(n)$  minus the number of cycles that should have occurred up to  $T(n)$  based on a constant IF frequency  $\text{IF est}$ , times the number of degrees per cycle.

If the starting point is NOT zero, that is Extended Function 81 or 88 is invoked, the above formula for phase must be modified. A more general form for the formula for the upper sideband is:

$$\theta(n) = \left[ (n) * (\text{IFPER}) - \frac{T(n) - \text{Data}(0)}{(1000) * \text{PROFAVG}} * (\text{IF est}) \right] * 360$$

For the lower sideband the formula reads:

$$\theta(n) = - \left[ (n) * (\text{IFPER}) - \frac{T(n) - \text{Data}(0)}{(1000) * \text{PROFAVG}} * (\text{IF est}) \right] * 360$$

This calculation can be made at each point and displayed as  $\theta$  vs Time. Additional filtering can be done to smooth out some of the measurement random error.

You can apply filtering to the data prior to performing the above calculations. A simple and commonly used algorithm is a moving window filter. This technique simply averages contiguous data points for a new estimator of time. This new estimator can then be used in the above formula.



# Index

!

1 MHz out/10 MHz out .....	3-22
1 M $\Omega$ key/mode .....	1-9, 3-11
2 Hz pulse mode .....	1-7
50 $\Omega$ key .....	1-9, 3-11

## A

A1 TBB/PS control assembly .....	2-91
A12 microwave assembly .....	2-96, 3-11
A5 synthesizer assembly .....	2-91 - 2-92
A5 synthesizer W2 output cable .....	2-95
A6 IF assembly .....	2-95 - 2-96
A6 LEDs .....	2-69
A9 gating assembly .....	2-68
Ac fuse .....	B-9
Ac line cord connectors .....	1-23
Ac line fuse .....	1-5
Ac power .....	3-9, 3-23
Ac power cord connectors .....	1-23
Ac power module .....	2-17, 3-21
Ac power plug .....	1-5
Ac power source .....	1-5
Ac power voltage .....	1-5
Ac sources .....	3-21
Ac voltage selection .....	2-17
Accept instrument setup .....	4-43
Accessories available .....	1-23
Accessories supplied .....	1-23
Accessory part numbers .....	1-23
Acquisition methods .....	3-10
Addition .....	1-12
Address 31 .....	3-9
Address selection .....	3-22
Address switch settings .....	3-10
Alphanumeric characters .....	1-2
AM tolerance .....	2-7
Analog circuit verification .....	2-84
Analog data .....	3-23
Annunciator descriptions .....	3-15

APC 3.5 female connector .....	1-6, 1-8
Appendix A .....	B-1
Arithmetic operations .....	1-12
Arm active .....	3-20
Arm gate mode .....	3-8
Arm mode .....	1-4, 1-11, 3-20
Arming .....	2-40
Arming vs Gating .....	D-2
ASCII display codes .....	3-13
Attenuator .....	1-20
Attenuator 1 .....	1-22
Attenuator 2 .....	1-22
AUTO .....	4-23
Auto annunciator .....	3-11
AUTO key .....	2-5, 3-11
Auto mode .....	3-10 - 3-11
Auto mode 2 ms, 50 Hz PRF test .....	C-29
Auto mode, 100 ns, 2 MHz PRF test .....	C-27
Auto pulse profiling .....	1-16, D-7
Automatic acquisition mode .....	4-23
Automatic CW/pulse signal acquisition .....	2-76
Automatic data collection .....	1-22
Automatic measurement mode .....	2-23, 3-11
Automatic mode .....	2-5
Automatic signal acquisition .....	1-4, 2-19
Automatic test .....	1-22
Auxiliary equipment .....	3-22
Auxiliary gate control .....	2-6
Auxiliary signal connections .....	1-3
Available options .....	1-22
AVER .....	4-24
Average measurement modifier .....	4-24

## B

Band switching .....	1-4, 2-26
Basic CW Measurements for INPUT 2 .....	1-13
Basic measurement modes .....	2-19
Basic Pulse/CW Measurements for INPUT 1 .....	1-13
Binary value .....	4-12

Binary weights ..... 4-11  
 Blank characters ..... 3-13

**C**

Calibration cycle ..... C-4  
 Calling extended functions ..... 2-58  
 Carrier frequency ..... 3-4  
 Center frequency ..... 1-10  
 Center frequency (CF) ..... 1-7, 3-3, 3-12  
 Center frequency limits ..... 3-12  
 CF entry error ..... 3-12  
 CF measurement error ..... 3-12  
 Changing an offset value ..... 2-52  
 Changing current resolution ..... 2-43  
 Changing current sample rate ..... 2-48  
 Changing extended functions ..... 2-59  
 Changing gate width by events ..... 2-77  
 Changing gate width time ..... 2-75  
 Changing number of averages for  
     frequency measurement ..... 2-75  
 Changing offset to last value ..... 2-54  
 Changing pulse average value ..... 2-46  
 Changing scale factor ..... 2-56  
 Changing the HP-IB address ..... 2-81  
 Changing to next extended function ..... 2-60  
 Character data ..... 4-18  
 Checking instrument status ..... 4-9  
 Checksum routine: ROM ..... 2-93  
 CHIRP ..... 4-24  
 Chirp Measurements  
     EFUN 96 ..... D-6  
 Chirp radar ..... 1-16  
 CIL programming language ..... 2-11  
 Circuit assembly ..... 3-10  
 CLR ..... 4-24  
 COARSE data: profiling ..... 2-71, D-13  
 Command elements ..... 4-13  
 Command function names ..... 4-14  
 Command header ..... 4-14  
 Command header summary ..... 4-14  
 Command separators ..... 4-16  
 Command syntax ..... 4-12  
 Complete performance testing ..... C-2  
 Configuration ..... B-6, B-8  
 Configuration: printer ..... 2-83

Container ..... B-9  
 Continuous wave (CW) ..... 1-2  
 Control/data group ..... 3-3  
 Control/data keys ..... 1-11, 3-6  
 Controller ..... 1-18, 1-20, 1-22  
 Controller address ..... 2-81  
 Controls and indicators ..... 3-1  
 Correcting problems ..... 2-81  
 Counting ..... 1-3  
 Counting accuracy ..... 2-3  
 Counting check: INPUT 2, CW ..... C-5  
 Counting circuitry ..... 1-2  
 Current address ..... 3-9  
 Current routine ..... 3-8  
 Custom measurement setup ..... 2-9  
 Customized measurement setup ..... 1-13  
 CW carrier frequency ..... 1-9  
 CW frequency measurement ..... 1-10  
 CW frequency profiling ..... D-7  
 CW frequency range ..... 1-8  
 CW inputs ..... 1-3  
 CW measurement ..... 1-8  
 CW measurement/trigger/report example  
     program ..... 4-51  
 CW measurements ..... 3-7, 3-10, 3-23  
 CW microwave counter ..... 1-4  
 CW only signal measurement ..... 2-76  
 CW phase profiling ..... D-18  
 CW profiling ..... D-7  
 CW signal inputs ..... 1-5  
 CW signals: INPUT 1 ..... 1-9  
 CW sweep ..... 2-31 - 2-32  
 CW sweep profile ..... 2-28  
 CW sweep: profile ..... 2-2

**D**

DAC ..... 1-20  
 DAC output ..... 1-20  
 Data ..... 4-16  
 Data display ..... 1-2  
 Data entry assignments ..... 3-2  
 Data entry considerations/problems ..... 2-21  
 Data field ..... 4-21  
 Data fields ..... 4-16  
 Data filtering: profiling ..... 2-73, D-13



Efun 81 ..... 2-70  
 Efun 82 ..... 2-71  
 Efun 83 ..... 2-71  
 Efun 84 ..... 2-72  
 Efun 85 ..... 2-73  
 Efun 86 ..... 2-74  
 Efun 87 ..... 2-74  
 Efun 88 ..... 2-74  
 Efun 89 ..... 2-75  
 Efun 90 ..... 2-75, 4-31  
 Efun 91 ..... 2-75, 4-38  
 Efun 92 ..... 2-76, 4-36  
 Efun 93 ..... 2-76, 4-37  
 Efun 94 ..... 2-4, 2-44, 2-77  
 Efun 95 ..... 4-31  
 Efun 97 ..... 2-78  
 Efun 98 ..... 2-78  
 Efun 98 exit procedure ..... 2-79  
 Efun 99 ..... 2-79  
 Efun 99 exit procedure ..... 2-80  
 EFUN? ..... 4-28  
 EFUN? query ..... 4-20  
 EFUNPARAM ..... 4-28  
 Entering parameter values ..... 2-20  
 Envelope characteristics ..... 2-28  
 Equipment options ..... 1-22  
 Equipment required ..... C-2  
 ERR? ..... 4-28  
 Error codes ..... 4-23  
 Error handling ..... 4-22  
 Error messages ..... 2-88, 3-4  
 Error/failure messages ..... 2-88  
 Error: profile plot ..... 2-32  
 Errors ..... 4-22  
 ESD precautions ..... 1-5  
 ESTART ..... 4-29  
 EXTENDED FUNCTION key ..... 2-9, 2-59 - 2-60  
 Extended function and diagnostic results ..... 4-20  
 Extended function calls ..... 1-12  
 Extended function key ..... 3-8  
 Extended function mode ..... 3-4  
 Extended function modes ..... 3-4  
 Extended function parameter ..... 4-28  
 Extended functions ..... 1-2, 1-5, 1-9, 1-12 - 1-13,  
 2-3, 2-9 2-58, 4-27

Extended functions/Codes ..... 2-63  
 Extended functions: measurement/setup ..... 2-61  
 Extended functions: special exit procedures ..... 2-60  
 Extended hardware support ..... 1-24  
 Extender boards ..... 1-24  
 Extender cables ..... 1-24  
 External arm signal connection ..... D-6  
 External arm signal timing ..... D-6  
 External arming procedure ..... 2-41  
 External arming: use details ..... D-6  
 External gate ..... 1-11  
 External gate mode ..... 1-4, 1-22, 3-8  
 External gate mode test ..... C-32  
 External gate signal connection ..... D-3  
 External gate signal timing ..... D-3  
 External Gate/ Arm In test ..... C-30  
 External gating ..... 1-2, 1-20, 2-38  
 External gating procedure ..... 2-39  
 External gating/arming ..... 2-6  
 External gating: use details ..... D-2  
 External mode ..... 3-20  
 External reference control signal ..... 3-22  
 External reference in ..... 3-22  
 External reference requirements ..... 3-22  
 External-gate pulse carrier/PRF measurement  
 example program ..... 4-52

**F**

Fail Self Check ..... 3-10  
 Failure message display ..... 2-85  
 Field-installable options ..... B-10  
 FILTER ON/OFF: profiling ..... 2-73, D-13  
 FINE ..... 4-29  
 FINE data: profiling: ..... 2-71, D-13  
 FM acquisition time ..... 3-10  
 FM CW signals ..... 1-11  
 FM deviation ..... 3-10  
 FMRATE ..... 4-30  
 FM rate/track ..... 2-49  
 FM RATE/TRACK key ..... 1-11, 2-7, 2-50, 3-10  
 FM rate/tracking ..... 2-7  
 FM rate: high ..... 3-10  
 FM rates ..... 1-11  
 FM rates: low ..... 3-10  
 FM tolerance ..... 1-4, 1-11, 2-7

FM tolerance test ..... C-25  
 FM track mode .....1-11  
 FM track/rate mode .....3-10  
 FREQ ..... 4-30  
 FREQBAND? ..... 4-30  
 Frequency bands .....1-4  
 Frequency coverage ..... 2-2  
 Frequency display format ..... 2-4  
 FREQUENCY function .....1-4  
 FREQUENCY key ..... 2-31  
 Frequency measurement averaging ..... 2-75  
 Frequency measurement example program ..... 4-48  
 Frequency measurement with trigger  
     example program ..... 4-48  
 Frequency modulation ..... 2-7  
 Frequency profile ..... 1-2, 1-13, 1-20, 2-2, 2-28 - 2-29,  
     3-4 - 3-5, D7  
 Frequency resolution .....3-8  
 Frequency: pulse envelope .....1-2  
 Front panel annunciators ..... 3-13, 3-15  
 Front panel connectors .....3-19  
 Front panel data entry .....3-4  
 Front panel display ..... 2-2  
 Front panel display and annunciators ..... 3-13  
 Front panel features .....1-2, 3-2  
 Front panel keyboard ..... 3-2  
 front panel keys ..... 3-1 - 3-2  
 Front panel self check function ..... 2-89  
 Front panel setup .....1-2  
 FUNC? ..... 4-30  
 Function 54 Calibrating ..... 2-94  
 Function annunciators ..... 1-2  
 Function group ..... 3-3  
 Function key ..... 3-7  
 Function key operation ..... 2-29  
 Function keys .....1-22  
 Function selection ..... 3-2  
 Functional block diagram .....1-1  
 Functional purpose: signal .....3-19  
 Functions .....1-2  
 Fuse selection .....1-5, B-2

## G

GATE .....4-31  
 Gate ..... 1-22, 4-31

Gate annunciator ..... 3-9  
 Gate bias calibration ..... 2-68, 2-84  
 Gate bias calibration error ..... 2-66  
 Gate duration ..... 2-6  
 Gate location ..... 3-19  
 Gate mode ..... 1-4, 1-11  
 GATE MODE key .....1-11, 2-6, 2-37 - 2-40, 3-8  
 Gate modes ..... 2-3, 2-6  
 Gate onset ..... 3-20  
 Gate pulse ..... 3-19  
 Gate status ..... 3-13  
 Gate time ..... 3-7, 3-10, 3-20  
 Gate time control ..... 2-6  
 Gate width ..... 3-19  
 Gate width by events ..... 2-77  
 Gate width time ..... 2-75  
 Gate width vs accuracy .....D-5  
 GATE/ARM IN connector ..... 2-3, 2-6, 2-37, 3-20  
 GATE/ARM IN operating considerations .....D-5  
 Gate/arm in waveform ..... 3-21  
 GATE/ARM input ..... 1-3, 1-22, 3-8, 3-20  
 Gate/measurement window ..... 1-20  
 Gating ..... 3-8  
 Gating and Arming ..... 2-37  
 Gating vs arming .....D-2  
 GHz/ms key ..... 2-20  
 GP-IB ..... 2-9  
 Grounding ..... 2-17  
 Guided tour ..... 1-5  
 Gunn diode oscillator ..... 1-16  
 GWID ..... 4-31

## H

HARM? ..... 4-32  
 HARMDET ..... 4-32  
 Harmonic number ..... 2-64  
 Harmonic number fraction ..... 2-64  
 Harmonic numbers: narrow pulse ..... 2-69  
 Headers ..... 4-16  
 HIGHBAND ..... 4-32  
 High band ..... 2-26  
 High band annunciator ..... 2-26  
 High resolution ..... 2-4, 2-44, 2-77  
 High resolution displays ..... 2-45  
 High resolution function ..... 4-33

HIGHZ ..... 4-33  
 HIRESOL ..... 2-5, 4-33  
 Hold ..... 1-11  
 Hold annunciator ..... 3-9  
 Hold sample rate ..... 3-11  
 HP 5361B basic functions ..... 1-4  
 HP 5361B guided tour ..... 1-4  
 HP 5361B overview ..... 1-1  
 HP 5361B signal flow ..... 2-2  
 HP 9000 program listing ..... C-36  
 HP harmonic heterodyne conversion ..... 1-3  
 HP harmonic heterodyne technique ..... 2-2  
 HP-IB ..... 1-20, 3-13, 3-22, 4-1 - 4-2, B-6, B-8  
 HP-IB address ..... 3-9  
 HP-IB ADDRESS key ..... 2-80 - 2-81, 3-9  
 HP-IB address switch ..... 2-80, 3-22  
 HP-IB cables ..... 2-9  
 HP-IB commands ..... 4-23  
 HP-IB configuration ..... 2-9, 2-58, 2-80, 4-2  
 HP-IB connector ..... 3-22  
 HP-IB control ..... 1-2  
 HP-IB interface ..... 4-20  
 HP-IB interface verification ..... 2-85, 2-97  
 HP-IB programmability ..... 1-2  
 HP-IB programming ..... 1-20, 3-13  
 HP-IB Tutorial ..... 4-1  
 HP-IB verification ..... C-2, C-12

I

ID prefix ..... 2-74, D-14  
 ID? ..... 4-33  
 IF amplification ..... 1-3  
 IF cycles per step: profiling ..... 2-75, D-15  
 IF detection ..... 1-3  
 IF detection software flag ..... 2-69  
 IF detector ..... 2-69  
 IF display ..... 2-68  
 IF filtering ..... 1-3  
 IF frequency ..... 2-63  
 IF inband detector ..... 2-68  
 IF out ..... 3-23  
 IF output specifications ..... 3-23  
 IFPER ..... 4-34  
 IF signal ..... 1-3, 3-19, 3-23  
 IF signal monitoring ..... 3-23

IF status display ..... 2-69  
 IF verification ..... 2-95 - 2-96  
 In-depth information ..... 2-1  
 INC key ..... 2-19 - 2-20  
 Increment ..... 2-19  
 Increment key ..... 3-7 - 3-8  
 Indicators ..... 3-1  
 INIT ..... 4-34  
 Initialize instrument ..... 4-34  
 INPUT 1 ..... 1-4 - 1-6, 1-8, 1-20, 1-22, 3-10, 3-23  
 INPUT 1 connector ..... 3-19  
 INPUT 1 input impedance ..... 2-30  
 INPUT 1 pulse measurements ..... 2-30  
 INPUT 1 signal connection ..... 1-6  
 INPUT 1, manual mode ..... 4-36  
 INPUT 1: maximum power ..... 2-16  
 INPUT 1 pulse width/repetition frequency test .. C-27  
 INPUT 2 ..... 1-5, 1-8, 1-20, 3-5, 3-11  
 INPUT 2 connector ..... 3-19  
 INPUT 2, 1 MOHM ..... 4-33  
 INPUT 2, 1 MOHM mode verification ..... 2-92  
 INPUT 2, 50 OHM mode verification ..... 2-91  
 INPUT 2, 50 OHMS ..... 4-35  
 INPUT 2: maximum input power ..... 2-16  
 Input cable considerations ..... 2-17  
 Input impedance ..... 1-20, 3-19  
 Input impedance 1 MOHM ..... 1-5  
 Input impedance: 50 OHMS ..... 1-5  
 Input signal ..... 1-11, 1-22  
 Input signal stability ..... 1-17, 2-71, D-12  
 Inspection before use ..... 2-13, B-2  
 Installation ..... B-11  
 Installing options ..... 1-22  
 Instrument clear ..... 4-24  
 Instrument controller ..... 1-16  
 Instrument covers ..... 3-22  
 Instrument parameter default/standby values ... 2-20  
 Instrument purpose ..... 1-4  
 Instrument status ..... 4-10  
 Instrument testing ..... 1-2  
 Interface functions ..... 4-4 - 4-5  
 Interface Status ..... 4-9  
 Intermediate frequency ..... 2-2  
 Internal gate ..... 1-11  
 Internal gate mode ..... 1-4, 3-8  
 Internal gating ..... 1-2, 2-6, 2-38



Internal instrument tests	2-89
Internal oscillator signal	3-22
Internal parameters	1-13
Internal timing circuitry	3-22
Interpolator check	2-92
Interpolator long calibration	2-65
Interpolator short calibration	2-65
Interpolator start/stop counts	2-65
Interpolator start/stop counts: current measurement	2-65
Intra-pulse frequency changes	1-16
Invalid number	3-9

## K

Key assignments	3-2
Key functions/locations	3-3
KEY?	4-34
Keyboard check	2-14, 2-87, 2-97
Keyboard entry	3-13
keyboard layout	3-2
Keyboard lockout message	2-79
Keyboard memory	2-21
kHz/ns key	2-20

## L

Last measured CF entry	2-25
LAST V key	2-8, 3-3, 3-6
LCD character set	3-13
Least significant digit (LSD)	1-11
Least significant digits (LSD)	1-12
Level condition	2-63, 3-11 - 3-12
Level detector check	2-96
Limiter	B-12
Line fuse	2-15, 3-21
Line voltage	3-21, B-2
Line voltage selection	3-21
Line voltage selector card	1-5, 3-21
Liquid crystal display	1-2, 3-13
LO?	4-36
LO frequency	2-64
LO frequency bounds	2-95
LO frequency selection	2-66
LO harmonic	3-23
LO mixing	3-23

LO synthesizer sweep	2-95
LO synthesizer verification	2-94
Local operation	4-48
Local oscillator	2-2
Locked keyboard	2-32, 2-83
LOWBAND	4-35
Low band	2-26
Low FM rate	1-4, 1-11, 3-10
Low frequency 1M $\Omega$ measurement mode	2-27
Low frequency 50 $\Omega$ measurement mode	2-27
Low frequency input fuse	2-15
Low PRF mode	2-30
Low pulse repetition frequency	4-36
LOWZ	4-35
LPRF	4-36
LST VAL key	2-54

## M

Maintenance	B-9
Male BNC connector	1-8
MANUAL	4-36
Manual center frequency	2-5
Manual center frequency entry	2-24
Manual dump mode measurement example program	4-50
MANUAL key	2-5, 2-37, 3-12
Manual measurement mode	2-24
Manual mode	2-5, 3-11 - 3-12
Manual mode, 90 ns, 2 MHz PRF test	C-28
Manual signal acquisition	1-4
Math functions	2-3, 3-12
Math group	3-3
Math key functions	1-12
Math key group	1-12
Math modification	1-4
Math modifiers	1-2, 1-9, 1-12, 2-51, 3-13
Math operations	1-12
Math overflow	2-33
Maximum input power	1-5
Maximum input signal power	2-16
Maximum operating input power	2-16, 2-30
Measured frequency	3-12
Measurement applications	1-1
Measurement customization	2-63
Measurement cycle	2-63, 4-19

Measurement data field ..... 4-21  
 Measurement dead-time ..... 2-6, 2-47  
 Measurement display ..... 1-11  
 Measurement gate time ..... 3-10  
 Measurement information ..... 2-9  
 Measurement mode keys ..... 3-11 - 3-12  
 Measurement mode selection ..... 2-19  
 Measurement modes ..... 1-2, 2-23, 3-19  
 Measurement modifier keys ..... 1-11  
 Measurement modifiers . 1-2, 1-9, 1-11, 1-13, 2-41, 3-13  
 Measurement output formats ..... 4-19  
 Measurement parameter ..... 2-63  
 Measurement technique ..... 2-2  
 Measurement value ..... 3-5  
 Memory verification ..... 2-84  
 Message display ..... 1-2  
 Message display section ..... 3-13  
 Meta messages ..... 4-7  
 MHz/us key ..... 2-20  
 Microprocessor ..... 1-2 - 1-3, 3-22  
 Microprocessor control ..... 2-2  
 Microwave assembly ..... 4-44  
 Microwave pulse/CW input ..... 3-4  
 Microwave signal source ..... 1-5, 1-8  
 Minimum dead time ..... 3-9  
 Mixed number ..... 1-12  
 MMOD ..... 4-36  
 MRC channel A verification ..... 2-92  
 MRC channel B verification ..... 2-92  
 MRC E & T registers ..... 2-63  
 MRC E & T registers: pulse measurements ..... 2-65  
 MRC long calibration ..... 2-65  
 MRC short calibration ..... 2-65  
 Multiplication ..... 1-12  
 Multiplication factor ..... 3-6

**N**

Narrow pulse mode ..... 2-30, 2-76  
 Narrow pulse/manual CF measurement  
     example program ..... 4-52  
 Normal FM rate ..... 1-4, 1-11  
 Not available condition ..... 3-9  
 NPUL ..... 4-37  
 Numeric data ..... 4-17

Numeric data entry ..... 3-3  
 Numeric output format ..... 4-20

**O**

OFFSET ..... 4-37  
 Offset ..... 1-4  
 Offset function ..... 1-12, 2-51  
 OFFSET key ..... 1-12, 2-8, 2-52 - 2-54, 3-6  
 Offset values ..... 2-7  
 Offset/scale: combined use ..... 2-8  
 OFFT ..... 4-37  
 OFFTIME ..... 1-4  
 OFFTIME key ..... 2-34  
 Operating characteristics ..... 2-2  
 Operating characteristics with options ..... 2-10  
 Operating functions ..... 3-15  
 Operating instructions ..... 2-11  
 Operating mode ..... 3-13  
 Operating modes ..... 3-13, 3-15  
 Operating problems ..... 2-81  
 Operating range selection ..... 2-4  
 Operating ranges ..... 2-4  
 Operation verification ..... C-2  
 Operation verification procedure ..... C-4  
 Operation verification record ..... C-15 - C-16  
 Operational verification ..... 3-10  
 Operator's checks ..... 2-12  
 Operator's maintenance ..... 2-15  
 Option 001 ..... 2-10  
 Option 006 ..... 2-10, B-12  
 Option 006 test specifications ..... C-4  
 Option 010 ..... 2-10  
 Option 026 ..... 2-10  
 Option 040 ..... 2-11, 2-26  
 Option 700 ..... 2-11  
 Option specifications ..... 1-22  
 Option W30 ..... 1-24  
 Optional input protection ..... 2-10  
 Options ..... 1-1, 1-22, B-10  
 Options available ..... 1-23  
 Ordered options ..... 1-22  
 Ordering options ..... 1-22  
 Oscilloscope ..... 1-20  
 Oscilloscope trigger input ..... 1-22  
 Oscilloscope vertical input ..... 1-22

Other outputs ..... 4-20  
 Output strings ..... 4-21  
 Oven oscillator ..... 2-10, 3-3, 3-22  
 Oven Oscillator: High Stability ..... 2-10  
 OVEN? ..... 4-38  
 Overall description ..... 1-2, 2-2  
 Overflow causes ..... 2-89  
 Overflow output string ..... 4-22  
 Overflow warning ..... 2-89  
 Overload indication ..... 2-18  
 Overview ..... 1-1

## P

P WIDTH ..... 1-4  
 P WIDTH/OFFTIME key ..... 1-6, 2-33, 3-5  
 Packaging ..... B-9  
 Parameter display section ..... 3-13  
 Parameter entry mode ..... 2-20, 3-7 - 3-9  
 Parameter value entry ..... 2-20, 3-7  
 Pass Self-Check ..... 3-10  
 PAVER ..... 4-38  
 PC board assemblies ..... 1-24  
 Performance test procedures ..... B-13, C-19  
 Performance test record ..... C-17 - C-18  
 Phase profiling ..... D-18  
 Plotter ..... 1-20  
 Power cable ..... 1-23, 3-21, B-4  
 Power cord ..... 1-5  
 Power module ..... 1-5  
 Power module window ..... 3-21  
 Power source voltage ..... 1-5  
 Power supply circuit ..... 2-91  
 Power supply outputs ..... 2-91  
 Power supply verification ..... 2-91  
 Power switch ..... 1-5, 3-3  
 Power-on calibration ..... 1-5  
 Power-on initialization ..... 2-13  
 Power-on self check ..... 1-5  
 Power-on tests ..... 2-84  
 Power-up ..... 3-9  
 Power-up default conditions ..... 2-85  
 Power-up default values ..... 2-23  
 Power-up default/standby conditions ..... 2-19, 2-21  
 Power-up self check ..... 2-13, 2-84, C-4  
 Power-up self check restart ..... 2-85

Power-up status check ..... 2-85  
 Power-up/warm-up ..... 2-11  
 Preliminary procedures ..... 1-5, 2-17  
 Prescaling ..... 1-3  
 Preset ..... 1-12  
 Preset function ..... 2-21  
 PRF ..... 1-4, 4-38  
 PRF key ..... 2-36  
 PRF measurement ..... 2-35  
 PRF/PRI (1/PRF) key ..... 3-5  
 PRI ..... 1-4, 4-39  
 PRI key ..... 2-35  
 PRI measurement ..... 2-34  
 Printer ..... 1-20  
 Printer output results ..... D-9  
 Printer problems ..... 2-83  
 Printer setting ..... 2-32  
 Problem isolation ..... 2-89  
 Problems and solutions ..... 2-81  
 Processor standby RAM ..... 3-4  
 PROF ..... 4-39  
 PROFAVG? ..... 4-40  
 PROFILE function ..... 1-4  
 PROFILE key ..... 2-31 - 2-32  
 Profile: customizing ..... D-15  
 Profile: locked keyboard ..... 2-32  
 Profile: manual setup ..... 2-32, D-8, D-12, D-14  
 Profile: pulse carrier frequency ..... 1-4  
 Profile: Pulse/CW sweep ..... 3-4 - 3-5  
 Profile setup ..... 2-32, D-8, D-12, D-14  
 PROFTIME ..... 4-40  
 Program examples ..... 4-48  
 Program interrupts ..... 4-51  
 Program messages ..... 4-14  
 Programmable digital to analog converter (DAC) ..... 1-18  
 Programming ..... 4-1  
 Protective grounding ..... 3-21  
 Pulse averaging ..... 2-45, 3-8  
 Pulse burst ..... 1-22, 3-23  
 Pulse carrier frequency ..... 1-4, 1-6, 2-29  
 Pulse carrier frequency profile ..... 1-4  
 Pulse carrier measurement ..... 2-30  
 Pulse carrier profiling measurement ..... 2-31  
 Pulse data ..... 1-2  
 Pulse end ..... 3-23  
 Pulse envelope ..... 1-2

Pulse envelope measurement .....3-6  
 Pulse event timing .....3-23  
 Pulse frequency measurement .....1-7  
 Pulse frequency profiling .....D-7  
 Pulse measurement .....3-20  
 Pulse measurement procedure .....1-5  
 Pulse measurements .....1-6, 2-28 - 2-29, 3-7, 3-23  
 Pulse modes .....1-4  
 Pulse off time .....1-4, 2-29, 4-37  
 Pulse off time measurement .....1-6, 2-34  
 Pulse off time: OFFTIME .....3-5  
 Pulse only signal measurement .....2-76  
 Pulse onset .....1-4, 3-20, 3-23  
 Pulse out .....3-23  
 Pulse out signal specifications .....3-23  
 Pulse output connector .....2-3  
 Pulse output .....1-3  
 Pulse parameter averaging .....1-4  
 Pulse parameter measurements .....3-3  
 Pulse parameters .....1-2, 1-22  
 Pulse period .....1-2  
 Pulse Phase profiling .....D-18  
 Pulse profile .....2-2, 2-28  
 Pulse profiling .....1-16, 3-23, D-7  
 Pulse profiling controller configuration .....1-20  
 Pulse profiling test setup .....1-16, 1-18, D-8  
 Pulse repetition frequency .....1-4, 2-29, 4-39  
 Pulse repetition frequency measurement .....1-6  
 Pulse repetition frequency: PRF .....3-5  
 Pulse repetition interval .....1-4, 2-29, 4-39  
 Pulse repetition interval measurement .....1-7  
 Pulse repetition interval: PRI .....3-5  
 Pulse terminology .....2-28  
 Pulse width .....1-2, 1-4, 2-29, 4-41  
 Pulse width measurement .....1-6, 2-33  
 Pulse width/period (PRI) average measurement  
     example program .....4-53  
 Pulse width: P WIDTH .....3-5  
 Pulse/CW determination .....1-4  
 Pulse/CW measurements .....1-2  
 Pulse/CW signal parameters .....2-29  
 Pulsed magnetron .....1-16  
 Pulsed microwave signal source .....1-5  
 Pulsed microwave signals .....1-2  
 Pulsed radar signal .....1-20  
 Pulsed RF amplitude/time relationship ....C-9, C-21

Pushbutton keys .....1-2  
 PWID .....4-41

Q

Queries .....4-14  
 Query commands .....4-20  
 Query output formats .....4-22  
 Quick reference guide .....1-1, 1-6, 1-9, 1-11 - 1-15  
 Quick reference guide organization .....1-13

R

Radar test setup .....1-20, 1-22  
 Radar waveform measurement .....1-20  
 Radar waveform measurements .....1-16  
 RAM test .....2-93  
 Rear panel address switch .....3-9  
 Rear panel features .....3-21  
 Recommended test equipment .....1-24, C-4  
 REF? .....4-41  
 Reference outputs .....3-4  
 Reference signal output specifications .....3-23  
 Reference source .....3-22  
 Register, service request mask .....4-12  
 Remote control address .....3-22  
 Remote control annunciator .....4-10  
 Remote data display .....4-49  
 Remote measurement .....1-2  
 Remote operating mode .....3-4  
 Remote operation ...1-2, 2-9, 2-80, 3-13, 3-22, 4-1, 4-48  
 Remote timebase verification .....4-48  
 Remote triggering .....4-48  
 Repeated reset: Efun 43 .....2-93  
 RESET .....4-41  
 Reset .....1-12  
 RESET/LOCAL key .....2-20, 3-4  
 RESOL .....4-41  
 Resolution .....1-11, 2-4, 2-42  
 RESOLUTION key .....1-11, 2-42, 2-46, 3-7  
 Restart measurement .....4-41  
 REV? .....4-42  
 RF pulse signal .....1-20  
 RF signal acquisition .....1-4  
 ROM software version .....2-66  
 ROM test .....2-93

## S

- Sales and support .....1-24
- SAMPLE .....4-42
- Sample HP 5361B applications .....1-16
- Sample HP-IB verification listing ..... C-14
- Sample rate ..... 1-4, 1-11, 2-6, 2-47, 3-8 - 3-9
- SAMPLE RATE key ..... 1-11, 2-47 - 2-48, 3-9
- Sampling rate .....1-11
- SCALE ..... 4-42
- Scale .....2-8, 4-42
- Scale function ..... 1-12, 2-55
- SCALE key ..... 1-12, 2-8, 2-55 - 2-56, 3-6
- Scale/offset: combined use ..... 2-8
- Scaling .....1-4
- Scientific notation .....4-20
- SCOPE-VIEW output ..... 1-3, 1-22, 3-19, D-2
- SCOPE-VIEW output connector ..... 2-3, 3-20
- SCOPE-VIEW signal waveform .....3-20
- Selecting pulse envelope functions .....2-29
- Selecting the HP-IB address ..... 4-2
- Self Check .....3-10
- Self Check failed/passed .....3-10
- Self Check failure bypass .....3-10
- Self check/cal .....2-9, 2-80
- SELF CHECK/CAL key .....2-9, 2-85 - 2-86, 3-10
- Self Check/Cal mode .....3-4
- Self check/calibration .....2-84
- Self test .....3-10
- Send current pulse/CW functions .....4-30
- Send error number .....4-28
- Send extended function result .....4-28
- Send firmware revision date code .....4-42
- Send identity .....4-33
- Send instrument setup .....4-43
- Send number of last key pressed .....4-34
- Send oven status .....4-38
- Send self check results .....4-45
- Send serial number .....4-43
- Send time base reference status .....4-41
- Sensitivity test: INPUT 1 pulsed RF  
(500 MHz - MAX GHz) ..... C-10, C-22
- Sensitivity test: INPUT 1, 500 MHz -  
MAX GHz CW ..... C-7, C-20
- Sensitivity test: INPUT 1, 500 MHz -  
MAX GHz Pulse Input ..... C-9, C-21
- Sensitivity test: INPUT 2, 10 Hz -  
525 MHz CW ..... C-5, C-19
- SER? ..... 4-43
- Serial poll .....4-11
- Service ..... 1-1
- Service aids/contracts ..... 1-24
- Service equipment available ..... 1-24
- Service manual ..... B-12
- Service request ..... 4-10
- Service request mask ..... 4-11, 4-45
- Service test equipment ..... 1-24
- SET ..... 4-43
- Set Enter key ..... 3-3
- Set FM rate/track ..... 4-30
- Set frequency measurement ..... 4-30
- Set gate mode ..... 4-31
- Set gate width/trigger frequency measurement  
example program ..... 4-53
- Set harmonic number ..... 4-32
- SETIF ..... 4-44
- Set manual center frequency ..... 2-24
- Set resolution ..... 4-41
- Set sample rate ..... 4-42
- Set scale function ..... 4-42
- SET/ENTER key ..... 2-20, 3-7, 3-9
- Set/return status byte example program ..... 4-49
- SET? ..... 4-43
- Setup parameters ..... 1-2
- Shipment ..... B-8
- SIDEBAND? ..... 4-44
- Sideband location ..... 2-64
- Signal acquisition ..... 2-2, 3-10
- Signal connections ..... 3-1
- Signal gating ..... 1-3
- Signal source ..... 1-5
- Signal termination: 50 OHM/1 MOHM ..... 1-9
- Signal tracking ..... 3-10
- Signal type ..... 3-19
- Signed constant ..... 3-6
- Significant digits ..... 3-7
- Simplified HP 5361B block diagram ..... 1-3
- SLEEP ..... 4-44
- SMOOTH ..... 4-44
- Smooth ..... 1-4, 2-8, 4-44
- Smooth function ..... 1-12, 2-57
- SMOOTH key ..... 1-12, 2-8, 2-57, 3-7

Specifications ..... A-1  
 SRQ ..... 4-9  
 SRQMASK ..... 4-45  
 SRQMASK command ..... 4-11, 4-49  
 Stability: input signal ..... 1-17, 2-71, D-12  
 Stable digits ..... 3-7  
 Standard features ..... 2-3  
 Standby ..... 3-3, 3-9, 3-22  
 Standby mode ..... 1-2  
 Start IF cycle: profiling ..... 2-74, D-15  
 Start time: profiling ..... 2-70, D-12  
 Status ..... 4-9  
 Status byte ..... 4-10 - 4-11  
 Stop time: profiling ..... 2-71, D-12  
 Storage ..... B-8  
 String data ..... 4-19  
 Subtraction ..... 1-12  
 Syntax ..... 4-12  
 Syntax diagrams ..... 4-23

**T**

Take fastest measurements ..... 4-26  
 Talk only mode ..... 3-9  
 TCXO adjustment ..... 3-22  
 TCXO standard timebase ..... 3-22  
 Test failure bypass ..... 2-85  
 Test signal: 35 MHz ..... 2-95  
 TEST? ..... 4-45  
 TFINAL ..... 4-46  
 Theory of operation ..... 1-3  
 Time base verification ..... 2-91  
 Time delay ..... 1-20  
 Time-delayed measurement ..... 3-23  
 Timebase buffer ..... 3-3  
 Timebase buffer circuit ..... 2-91  
 Timebase buffer detection circuit ..... 3-22  
 Timebase verification example program ..... 4-48  
 Track mode ..... 1-4  
 TRIGGER ..... 4-46  
 Trigger ..... 1-11, 2-49, 4-46  
 TRIGGER key ..... 1-11, 2-6, 2-49, 3-9, 3-11  
 Troubleshooting ..... 2-9  
 TSTART ..... 4-47  
 TTL input ..... 3-20  
 Type N male connector ..... 1-6, 1-8

**U**

Unstable digits ..... 1-12  
 User-selected resolution ..... 1-11  
 Using external gating or arming ..... D-2  
 Using offset ..... 2-51  
 Using scale factor ..... 2-55  
 Using self check ..... 2-86  
 Using smooth function ..... 2-57  
 Using the current extended function ..... 2-59  
 Using the SCOPE-VIEW output ..... D-2

**V**

Value specifier ..... 4-19  
 VCO characterization ..... 1-16, 1-18  
 VCO characterization test setup ..... 1-18  
 VCO output ..... 1-20  
 Voltage ..... B-2  
 Voltage stimulus ..... 1-18

**W**

Whole number ..... 1-12



For more information, call your local HP sales office listed in your telephone directory or an HP regional office listed below for the location of your nearest sales office.

**United States of America:**

Rockville, MD  
(301) 670 4300  
Rolling Meadows, IL  
(708) 255 9800  
Fullerton, CA  
(714) 999 6700  
Atlanta, GA  
(404) 980 7351

**Canada:**  
(416) 678 9430

**Japan:**  
(8113) 3335 8192

**Latin America:**  
Mexico  
(525) 202 0155

Brazil  
(11) 709 1444

**Australia/New Zealand:**  
(03) 895 2895

**Far East:**  
Hong Kong  
(852) 848 7070

Korea  
(2) 769 0800

Taiwan  
(2) 717 9524

Singapore  
(65) 291 8554

India  
(11) 690 355

PRC  
(1) 505-3888

In Europe, Africa and Middle East,  
please call your local HP sales office  
or representative:

**Austria/South East Area:**  
(0222) 2500-0

**Belgium and Luxembourg:**  
(02) 778 31 11

**Denmark:**  
45 99 10 00

**Finland:**  
(90) 88 721

**France:**  
(1) 69.82.65.00

**Germany:**  
(06172) 16 0

**Greece:**  
(01) 68 28 811

**Ireland:**  
(01) 2844633

**Israel:**  
(03) 5380 333

**Italy:**  
(02) 92 122 241

**Netherlands:**  
(020) 547 6669

**Norway:**  
(02) 87 97 00

**Portugal:**  
(11) 301 73 30

**South Africa:**  
(011) 806 1000

**Spain:**  
900 123 123

**Sweden:**  
(08) 750 20 00

**Switzerland:**  
(057) 31 21 11

**Turkey:**  
(90-1) 4 125 83 13

**U.K.:**  
(0344) 362 867

For countries not listed, contact:  
Hewlett-Packard  
International Sales Branch  
Geneva, Switzerland  
Tel: +41-22-780-7111  
Fax: +41-22-780-7535

